



**VP** Valley  
Chrome  
Plating

**W I N G M A S T E R**  
BUMPERS AND ACCESSORIES  
CATALOG 2019



Online version updated June 2020



Welcome to Valley Chrome Plating, Inc./Wingmaster Company. We invite you to make Valley Chrome your first choice in replacement truck bumpers, and Wingmaster your preferred supplier of stainless steel accessories.

All Valley Chrome bumpers and Wingmaster stainless products are proudly made in the United States at our Clovis, California facility. Wingmaster uses the finest stainless steel available along with the highest quality standards, to ensure that all aftermarket accessories will meet the approval of the dedicated professionals in the transportation industry.

For over 57 years, we have produced quality products for the heavy truck industry. In addition to our stock replacement and custom-made products, we have built our reputation on great customer service, fair pricing and consistent deliveries. We hope you will experience what many have come to recognize, that Valley Chrome Plating, Inc./Wingmaster Company is an excellent business partner to the trucking community.

Please visit us on our web page and join the excitement on our social media pages. Our knowledgeable staff is ready to serve you by phone as well, by calling 1.800.354.0976.



# NEW PRODUCTS



## Bumper Bolt Kits

See page 80

- Polished stainless
- #12 - 1.75 x 50
- 4- and 8- piece kits
- Nylon washers to protect chrome
- Zinc plated washers & locknuts



## New Bumpers

See pages 24, 69, 73

- 2018 & newer Cascadia
- Western Star 5700XE
- 2017-newer Volvo VNL & VNR
- and more!

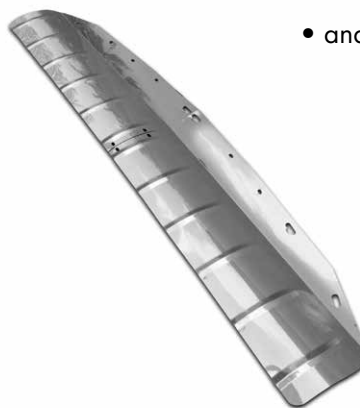

## Aerodynamic Air Foils

See Bumpers section

- Polished stainless; sturdier than plastic
- Mounts under our bumper bottom flange
- Moves air under the chassis for improved aerodynamics
- Call to arrange fleet fuel economy testing

# TABLE OF CONTENTS

## BUMPERS

Part Numbering Guide .....	7
Autocar .....	8
Ford .....	9-10
Freightliner .....	11-24
GMC .....	25-27
Hino .....	27a
International .....	28-34
Kenworth .....	35-43
Mack .....	44-53
Peterbilt .....	54-63
Sterling .....	64-65
Volvo .....	66-69
Western Star .....	70-73
White .....	74
Rear Bumpers .....	75
Misc. Bumper Options .....	76-79
Bumper Bolt Kits .....	80

## UNIVERSAL ACCESSORIES

Flap Weights .....	82
Tank Straps .....	82
Tag Hangers .....	82
Permit Panels .....	83
Ridged Permit Panels .....	84
Beacon Light Brackets .....	84
Airline Boxes .....	85
Deck Plates .....	86
Front Deck Plate Tool Box .....	86
Head Light Visors .....	87
Frame Steps .....	87
Rear Window Visors .....	88
Rear Frame Fillers .....	89
Lower Rear Frame Fillers .....	90
Retail Display - LEDs .....	91
LED Light Option Chart .....	92
Blank Light Cutout Options .....	93
LED Lights .....	94
Signature Marker Lights .....	95
LED Lights .....	96-97
Pete Turn/Park/Clearance Light .....	98
Wire Harnesses .....	99

## PETERBILT MODEL 359 ACCESSORIES

Cab Panel 3.5" .....	101
Hood Extensions .....	101
Misc. Trim Pieces .....	102
Standard Mount Stainless Visors .....	103
Gangster Stainless Visors .....	103
Air Deflectors .....	104
Fuel Tank Strap Covers .....	104
Misc. Trim Pieces .....	105

## PETERBILT MODELS 365 & 367

<b>ACCESSORIES</b> .....	106
Cab Panel 4" .....	107
Sleeper Panels 4" .....	108
Sleeper Extensions Panels 4" .....	109
Air Cleaner Light Boxes .....	110
Bug Shields .....	110

## PETERBILT MODEL 379

<b>ACCESSORIES</b> .....	111-112
One-Piece Cab/Hood Extension Panels .....	113
Cab Panels 4" .....	114
Cab Panels 6" .....	114
Hood Extension Panels 4" .....	115
Hood Extension Panels 6" .....	115
Sleeper Panels 4" .....	116
Sleeper Panels 6" .....	116
Sleeper Extension Panels 4" .....	117
Sleeper Extension Panels 6" .....	117
Air Cleaner Light Boxes Vortex .....	118
Mirror Light Boxes .....	119
Bumper & Grille Trim .....	120
Fender Guards .....	120
Bug Shields .....	121
Blinker Bars .....	122
Fender Support Covers .....	122
Sleeper Filler Panels .....	123
Sleeper Shock Covers .....	123
Air Deflectors .....	124
Fuel Tank Strap Covers .....	124
Fuel Tank Fairings .....	125
Emblems .....	126
Misc. Trim Pieces .....	126-127
Battery Boxes & Tool Boxes .....	128
Tool & Battery Box Covers .....	129

## PETERBILT MODEL 384

Cab Panels 4" .....	131
Cab Panels 6" .....	131
Sleeper Panels 4" .....	132
Sleeper Panels 6" .....	132
Sleeper Extension Panels 4" .....	133
Sleeper Extension Panels 6" .....	133

## PETERBILT MODEL 386

Cab Panels 2.5" .....	134
Exhaust Filler Panel 2.5" .....	135
Sleeper Panels 2.5" .....	136
Sleeper Extension Panels 2.5" .....	137
Bug Shields .....	137

## PETERBILT MODELS 388 & 389

Formed Cab Panels 4" .....	139
Formed Cab Panels 6" .....	139
One-Piece Cab/Hood Extension Panels, No DEF System .....	140
One-Piece Cab/Hood Extension Panels, No DEF System .....	141
One-Piece Cab/Hood Extension Panels, No DEF System .....	141-142
Cab Panels 4" .....	143
Cab Panels 6" .....	143
Cab Panels No DEF System .....	144
Cab Panels DEF System .....	144

Table of Contents continued on next page

# TABLE OF CONTENTS

Table of Contents continued from previous page

## **PETERBILT MODELS 388 & 389**

Sleeper Panels 4" .....	145
Sleeper Panels 6" .....	145
Hood Extension Panels 4" .....	146
Hood Extension Panels 6" .....	146
Hood Extension Panels 4" .....	147
Hood Extension Panels 6" .....	147
388 Cab Panel DEF System.....	148
388 Hood Extension Panel DEF System.....	148
Sleeper Extension Panels 4" .....	149
Sleeper Extension Panels 6" .....	149
Air Cleaner Light Boxes Donaldson .....	150
Mirror Light Boxes .....	151
Bumper & Grille Trim .....	152
Fender Guards .....	152
Bug Shields .....	152
Emblems .....	153
Fender Trim .....	153
Hood Trim .....	153
Blinker Bars .....	154
Fender Support Cover.....	154
Stainless Visors .....	155
Sleeper Filler Panels .....	155
Misc. Trim Pieces .....	156-157
Sleeper Shock Covers.....	158
Air Deflectors.....	158
Fuel Tank Strap Covers .....	159
Exhaust Covers .....	159
Tool & Battery Box Covers.....	160-161
Box Step Highlights/Protectors.....	161

## **PETERBILT MODEL 567**..... 162

Cab Panel.....	163
Sleeper Panels .....	163
Hood Extension Panels.....	163
Fender Guards .....	163
Bug Shields .....	164
Fuel Tank Strap Covers .....	164
Stainless Visors .....	165

## **PETERBILT MODEL 579**..... 166-167

Cab Panel.....	168
Sleeper Panels .....	168
DEF System Panels .....	169
Misc. Trim Pieces .....	170-171
Stainless Visors .....	172
Sleeper Shock Covers.....	173
Tank Fairing Highlight.....	173
Kick Panel Trim .....	173

## **PETERBILT MODEL 587**..... 174

Fender Trim .....	175
Stainless Visors .....	175
Misc. Trim Pieces .....	176

## **ACCESSORIES FOR**

### **ALL PETERBILT MODELS**..... 177

Hood Emblems .....	178-179
Hood Latch Guards .....	179
Key Guards.....	180
Misc. Trim Pieces .....	180-181
Window Trim .....	181
Sleep Window Lower Looks.....	181
Standard Mount Stainless Visors .....	182
Boltless Mount Stainless Visors .....	183
Boltless Stainless Visors .....	184
Gangster Stainless Visors .....	185
Sleeper Wraps .....	186
Rear Frame Covers.....	186
DEF Tank Covers .....	187
Fuel Tank Wraps.....	187

### **KENWORTH MODEL W900**..... 188

Cab Panels.....	189
Sleeper Panels .....	190
Hood Extension Panels.....	191
Sleeper Extension Panels.....	191
Air Cleaner Light Boxes.....	192
Air Cleaner Fairings .....	193
Exterior Window Trim.....	194
Exhaust Shields .....	194
Bug Shields .....	194
Blinker Bars .....	195
Flap Weights .....	195
Fender Guards .....	196
Battery & Tool Box Covers.....	196
Hood & Grille Trim .....	197
Stainless Sun Visors .....	198
Gangster Visors .....	199
Boltless Wicked Visors.....	200
Catalytic System Box Highlights .....	201
DEF Tank Cover .....	201
Stainless Deck Plates.....	201
Fuel Tank Fairings .....	202
Lower Hood Panels .....	203
Center Hood Trim.....	203

### **KENWORTH MODEL T600**..... 204

Sleeper Panels .....	205
Sleeper Extension Panels.....	205
Stainless Grilles .....	206
Bug Shields .....	206
Battery & Tool Box Covers.....	207
Side Marker Trim .....	207

### **KENWORTH MODEL T660**..... 208

Cab Panels .....	209
Bug Shields .....	209
Stainless Sun Visors .....	209
Gangster Visors .....	210
Boltless Wicked Visors .....	210
Battery & Tool Box Covers.....	211

Table of Contents continued on next page

# TABLE OF CONTENTS

Table of Contents continued from previous page

<b>KENWORTH T680</b> .....	212
Cab Panels.....	213
Sleeper Extension Panels.....	213
Door and Window Trim.....	213
Bug Shields.....	214
Fender Guards.....	214
Stainless Sun Visor.....	214
DEF Tank Cover.....	215

<b>KENWORTH T800 &amp; T880</b> .....	216
Sleeper Panels.....	217
Sleeper Extension Panels.....	217
Bug Shields.....	218
Fender Guards.....	218
Stainless Sun Visors.....	218
Gangster Visors.....	219
Boltless Wicked Visors.....	219
Battery & Tool Box Covers.....	220
Exterior Window Trim.....	221
Door Handle Trim.....	221
Lower Look.....	221
Air Deflectors.....	221
Emblem Accents.....	222
Hood Latch Guards.....	222
Sleeper Window Trim.....	223
Stainless Fuel Tank Wraps.....	223

<b>FREIGHTLINER FLD/CLASSIC</b> .....	224
Cab Panels 4".....	225
Sleeper Panels.....	225
Hood Latch Guards.....	226
Hood Trim.....	226
Lowered Look Window Panels.....	226
Misc. Trim Pieces.....	227
Air Cleaner Light Boxes.....	227
Fender Guards.....	228
Headlight Visors.....	228
Stainless Trim For Plastic Bumpers.....	228
Bug Shields.....	229
Sun Visors.....	230
Wicked Boltless Visors.....	231

<b>FREIGHTLINER CENTURY &amp; COLUMBIA</b> .....	232
Cab Panels 4".....	233
Sleeper Panels.....	233
Misc. Trim Pieces.....	233
Stainless Trim for Plastic Bumpers.....	234
Bug Shields.....	234
Sun Visors.....	235

<b>FREIGHTLINER CORONADO 2002-2009 &amp; GLIDER KITS</b> .....	236
Bug Shields.....	237
Sun Visors.....	237

<b>FREIGHTLINER CASCADIA 2017 &amp; OLDER "P3"</b> .....	238
Cab Panels 4".....	239
Sleeper Panels.....	239
Fairing Panels.....	240
Fender Trim.....	241
Hood & Door Trim.....	241
Lowered Look Window Panels.....	241
Stainless Trim For Plastic Bumpers.....	242
Bug Shields.....	242
Sun Visors.....	243
Fuel Tank Covers.....	244
Battery Box Covers & Steps.....	244
Catalytic Covers.....	244
Emblem Accents.....	245
Permit Panels.....	245
Fuel Tank Fairing.....	245

<b>VOLVO VNL</b> .....	246
Hood & Fender Trim.....	247
Bug Shield.....	247
Stainless Trim For Factory Visors.....	247
Fairing Highlights.....	248

<b>VOLVO VT SERIES</b> .....	249
Cab Panels.....	250
Sleeper Panels.....	250
Hood Extension Panels.....	251
Hood & Fender Trim.....	251-252
Bug Shield.....	252
Sun Visors.....	252
Battery Box Cover.....	253
Fuel Tank Fairings.....	253

<b>WESTERN STAR 4700SF</b> .....	254
Cab Panels.....	255
Fender Guards.....	255
Bug Shields.....	256
Radiator Rock Guard.....	256
Sun Visors.....	256

<b>WESTERN STAR 5700XE</b> .....	256a
----------------------------------	------

<b>TURBOWING BY WINGMASTER</b> .....	257
The Turbowing Advantage.....	258
Pickup Truck Wings.....	259
Aerolight 700 Series.....	260
900 Series.....	260
Peterbilt Wings/Mounting Kits.....	261
Hood Wings.....	261
Kenworth Wings/Mounting Kits.....	262
Hood Wings.....	262
Freightliner Wings/Mounting Kits.....	263
Hood Wings.....	263
International Wings/Mounting Kits.....	264
Hood Wings.....	265
Pro Tail Wings.....	266

<b>NOTES</b> .....	267-270
--------------------	---------

<b>WARRANTY AND RETURNS</b> .....	271
-----------------------------------	-----



## VALLEY CHROME PLATING PART NUMBER IDENTIFICATION

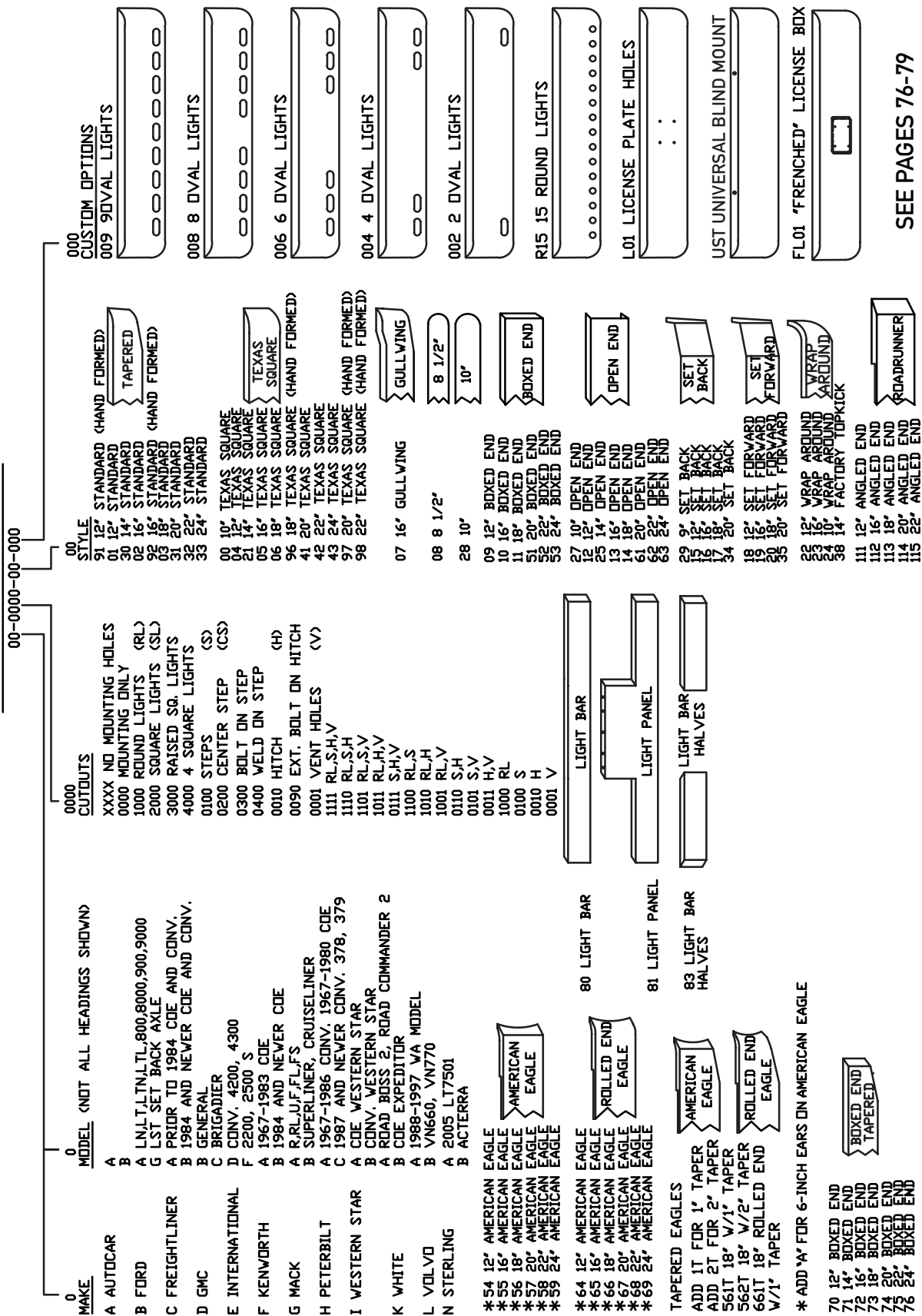

SEE PAGES 76-79  
FOR MORE OPTIONS

STANDARD AND SQUARE BUMPERS ARE MADE FROM 7-GAUGE (3/16") THICK STEEL  
20", 22" AND ALL BREAK-BACKS ARE MADE FROM 10-GAUGE (1/8") THICK STEEL  
ALL STAINLESS BUMPERS ARE MADE FROM 11-GAUGE (1/8") 304 STAINLESS STEEL

## AVAILABLE STYLES (see page 7 for more styles)



16"=-02  
18"=-03  
20"=-31  
22"=-32



16"=-10  
18"=-11  
20"=-51  
22"=-52



16"=-05  
18"=-06  
20"=-41  
22"=-42

Bumpers shown below are for MOUNTING and OPTIONS. To select a style use the two digit outside shape shown above as the last two digits of the part number.

### W/2" break-back (not available in 12" width)

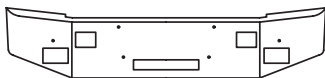

AA-2011-\_\_

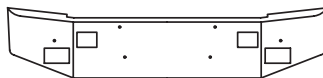

AA-2010-\_\_

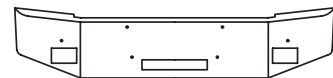

AA-2001-\_\_



AA-0011-\_\_

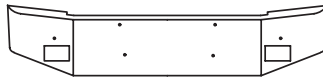

AA-2000-\_\_

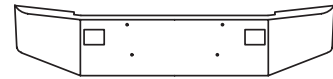

AA-0010-\_\_



AA-0001-\_\_

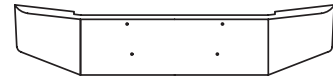

AA-0000-\_\_

### W/2" break-back

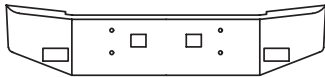

AB-2010-\_\_

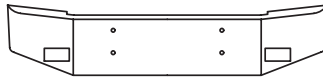

AB-2000-\_\_

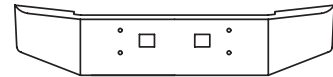

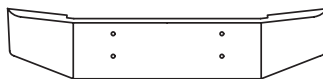

AB-0010-\_\_



AB-0000-\_\_

AVAILABLE STYLES (see page 7 for more styles)

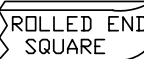
BA, BH	12"=-01	BF, BG	9"=-29	BA	10"=-00	BH	10"=-00
	16"=-02		12"=-15		12"=-04		12"=-04
	18"=-03		16"=-16		14"=-21		14"=-21
	20"=-31		18"=-17		16"=-05		16"=-05
	22"=-32				18"=-06		18"=-06
					20"=-41		20"=-97
					22"=-42		22"=-98

Bumpers shown below are for MOUNTING and OPTIONS. To select a style use the two digit outside shape shown above as the last two digits of the part number.

1970 - 1998

L-LN-LT-LTN-LTL-800-8000-900-9000, 1987 LN7000, STERLING LT9511

(must be 16" wide for 4010 option)

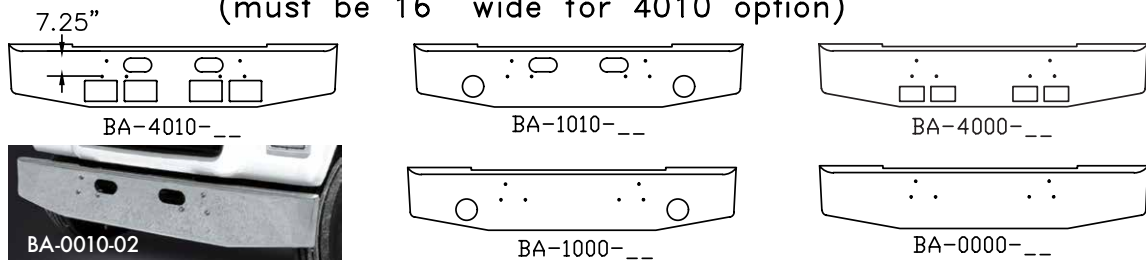

1988-1995 AEROMAX SET BACK AXLE L, LS, LA, LTS, LTA, 9000  
(please check the next category before ordering)

Not available in UST



1988-1995 LST SET BACK AXLE  
(please check the prior category before ordering)



1980-2003 F SERIES SET BACK AXLE W/9" break-back

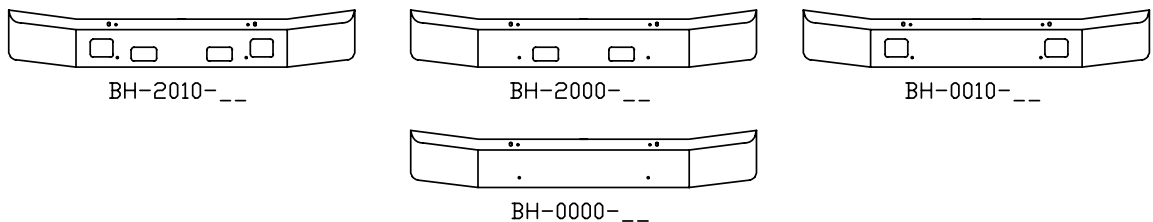

No WARRANTY on break-backs over 18"

AVAILABLE STYLES (see page 7 for more styles)

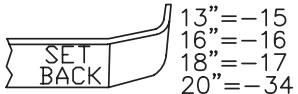

13"=-15  
16"=-16  
18"=-17  
20"=-34

Bumpers shown below are for MOUNTING and OPTIONS. To select a style use the two digit outside shape shown above as the last two digits of the part number.

## 2005-2015 F650 SUPER DUTY, CUMMINS 5.9L

(please check the next category before ordering)  
(brackets included, call for model year application)

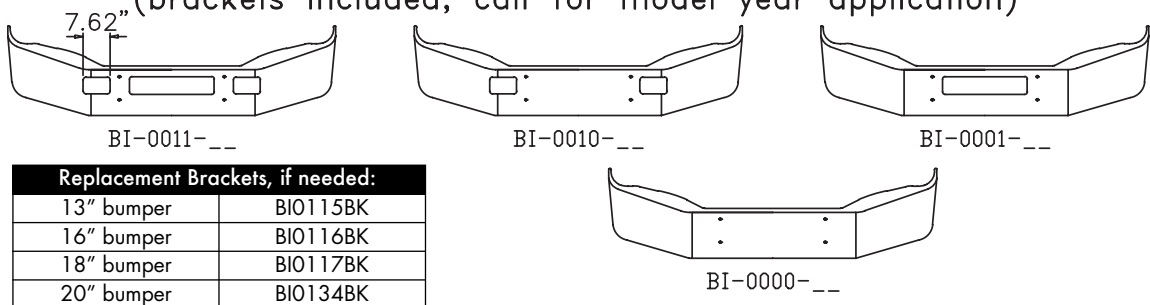

BI-0011-\_\_      BI-0010-\_\_      BI-0001-\_\_

BI-0000-\_\_

Replacement Brackets, if needed:	
13" bumper	BI0115BK
16" bumper	BI0116BK
18" bumper	BI0117BK
20" bumper	BI0134BK

## 2005-2015 F650 SUPER DUTY, CATERPILLAR C7

(please check the prior category before ordering)  
(brackets included, call for model year application)

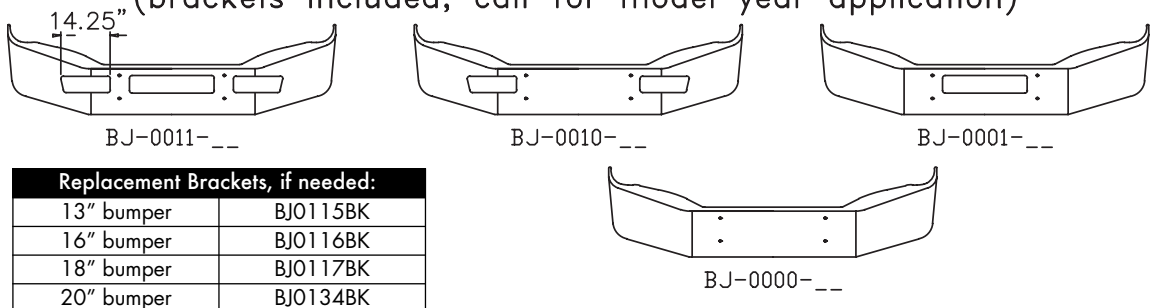

BJ-0011-\_\_      BJ-0010-\_\_      BJ-0001-\_\_

BJ-0000-\_\_

Replacement Brackets, if needed:	
13" bumper	BJ0115BK
16" bumper	BJ0116BK
18" bumper	BJ0117BK
20" bumper	BJ0134BK



**No WARRANTY on break-backs over 18"**



## AVAILABLE STYLES (see page 7 for more styles)

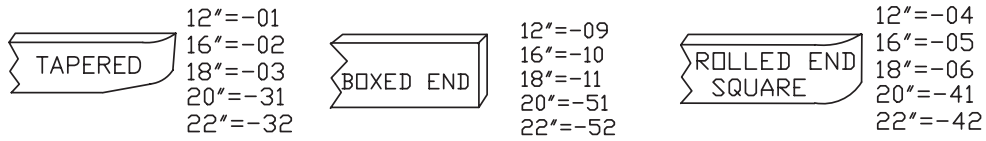

Bumpers shown below are for MOUNTING and OPTIONS. To select a style use the two digit outside shape shown above as the last two digits of the part number.

### 1980-1984 COE AND CONV. 92" LONG

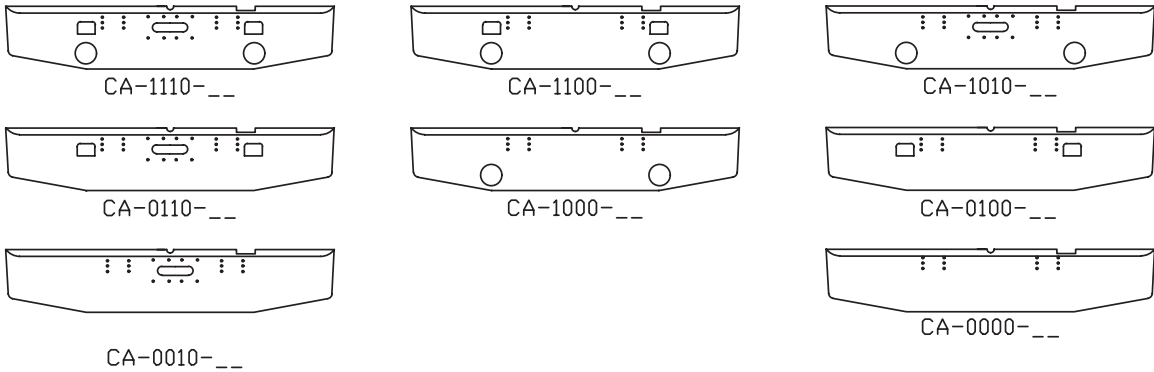

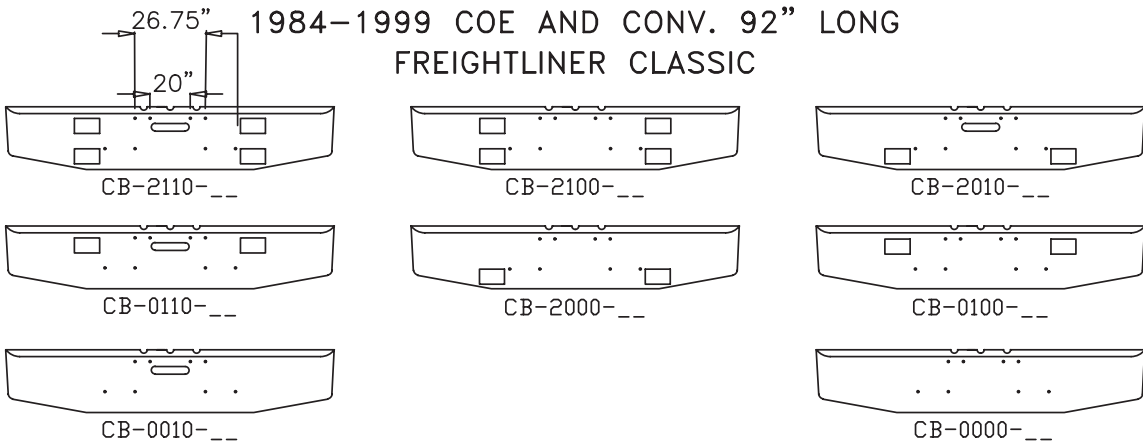

### 1984-1999 COE AND CONV. 92" LONG FREIGHTLINER CLASSIC



**VF120009**  
FL-TOW PIN COVER -CLASSIC -  
CLASSIC X L  
FITS CA& CB SERIES

## AVAILABLE STYLES (see page 7 for more styles)

 TAPERED	12"=-01	 BOXED END	12"=-09	 ROLLED END SQUARE	12"=-04
	16"=-02		16"=-10		16"=-05
	18"=-03		18"=-11		18"=-06
	20"=-31		20"=-51		20"=-41
	22"=-32		22"=-52		22"=-42

Bumpers shown below are for MOUNTING and OPTIONS. To select a style use the two digit outside shape shown above as the last two digits of the part number.

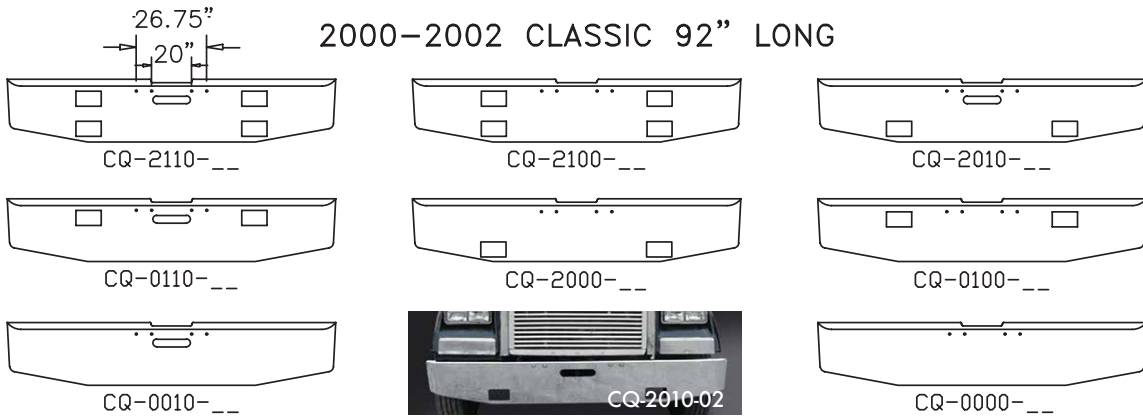

## 2002-2007 CLASSIC, 1200 SERIES 92" LONG

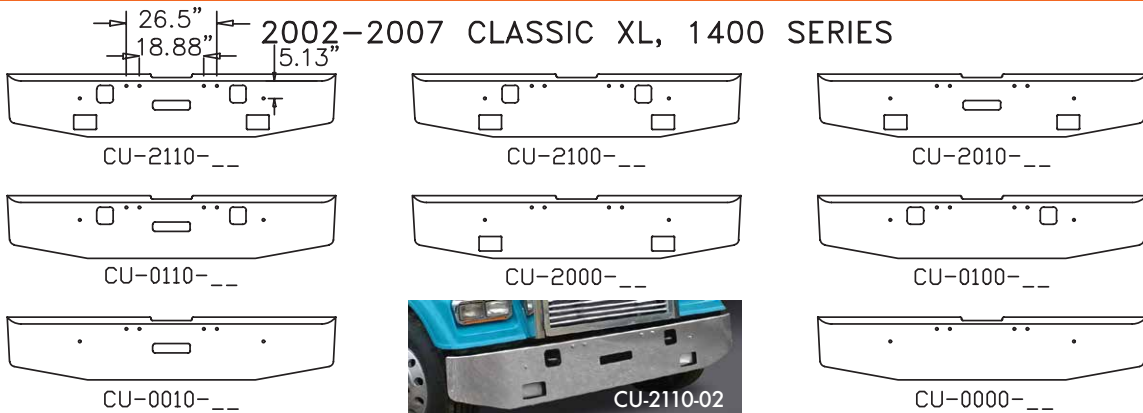
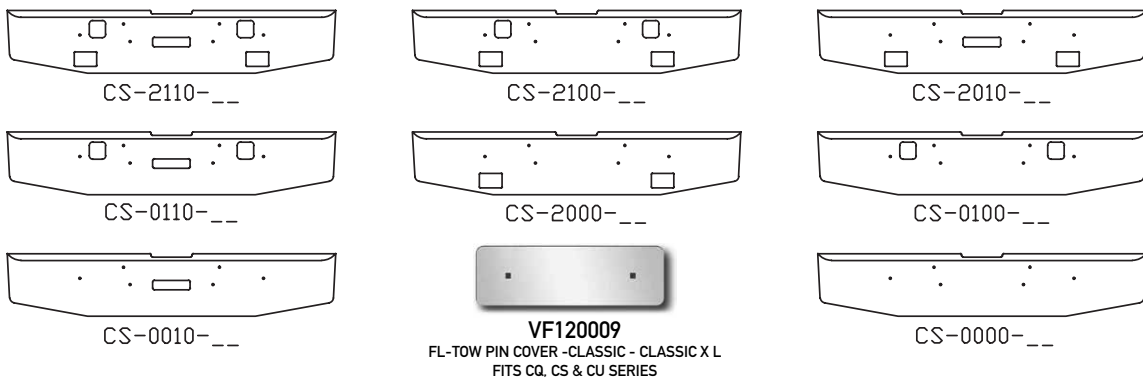

## AVAILABLE STYLES (see page 7 for more styles)

**TAPERED**  
 12"=-01  
 16"=-02  
 18"=-03  
 20"=-31  
 22"=-32

**BOXED END**  
 12"=-09  
 16"=-10  
 18"=-11  
 20"=-51  
 22"=-52

**ROLLED END SQUARE**  
 12"=-04  
 16"=-05  
 18"=-06  
 20"=-41  
 22"=-42

Bumpers shown below are for MOUNTING and OPTIONS. To select a style use the two digit outside shape shown above as the last two digits of the part number.

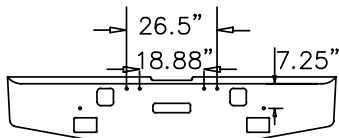

CV-2110-\_\_

### 2002-2007 CLASSIC XL



CV-2100-\_\_

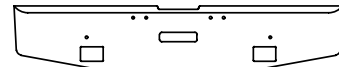

CV-2010-\_\_

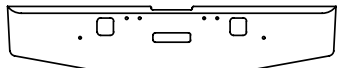

CV-0110-\_\_



CV-2000-\_\_

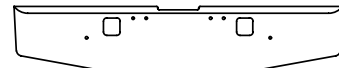

CV-0100-\_\_

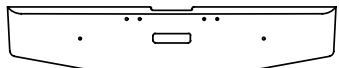

CV-0010-\_\_



CV-2110-02

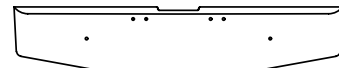

CV-0000-\_\_

### 2008-2010 CLASSIC XL (only available in 16" or wider)

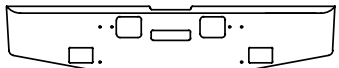

CX-2110-\_\_

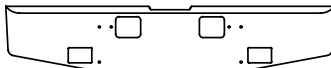

CX-2100-\_\_



CX-2010-\_\_

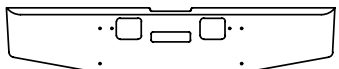

CX-0110-\_\_



CX-2000-\_\_

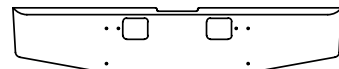

CX-0100-\_\_

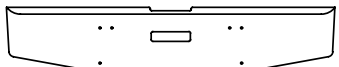

CX-0010-\_\_



**VF120009**  
 FL-TOW PIN COVER -CLASSIC - CLASSIC X L  
 FITS CV & CX SERIES



CX-0000-\_\_

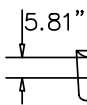

### 2012 AND NEWER 114SD SET FORWARD AXLE

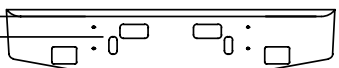

COI-2011-\_\_

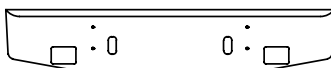

COI-2010-\_\_

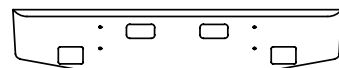

COI-2001-\_\_

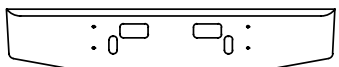

COI-0011-\_\_

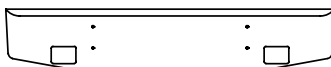

COI-2000-\_\_

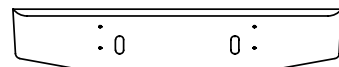

COI-0010-\_\_

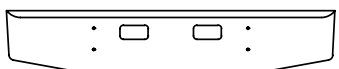

COI-0001-\_\_



COI-0011-02

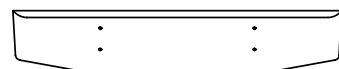

COI-0000-\_\_

## AVAILABLE STYLES (see page 7 for more styles)

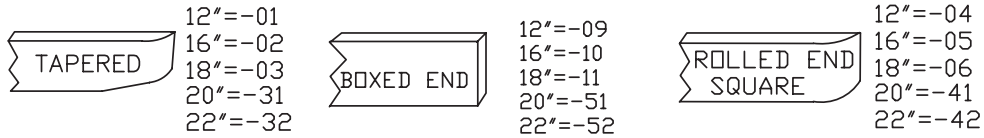

Bumpers shown below are for MOUNTING and OPTIONS. To select a style use the two digit outside shape shown above as the last two digits of the part number.

### 2002-2009 CORONADO, 2010-NEWER GLIDER KITS

(factory grill not included, not available in stainless steel)  
 (does not use factory support brackets or end caps)

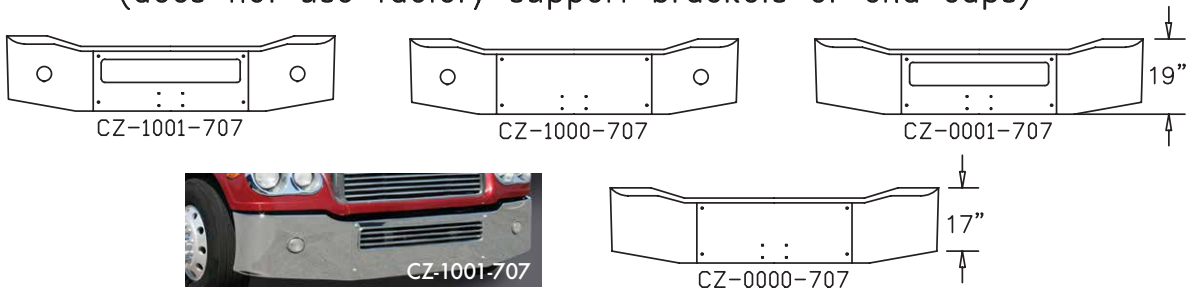

### 2010 AND NEWER CORONADO, 122SD SET FORWARD AXLE

16" and wider. See COE series (below) for 12" bumpers

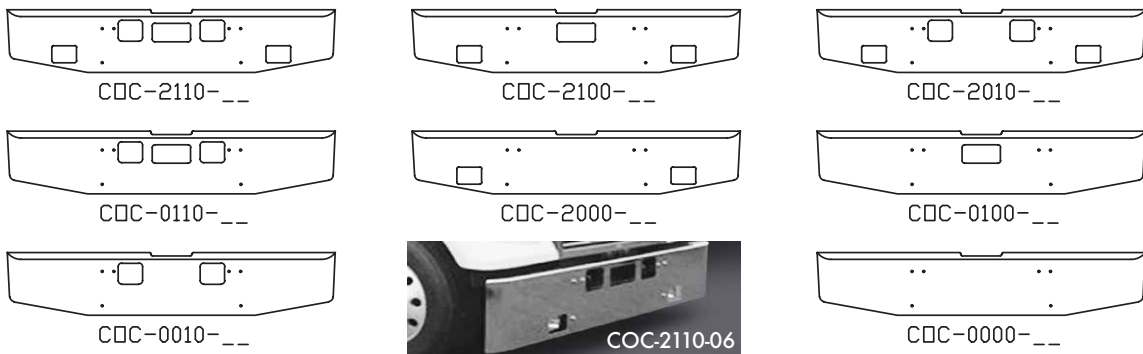

### 2010 AND NEWER CORONADO, 122SD SET FORWARD AXLE (HIGH GROUND CLEARANCE) 12" WIDE ONLY

For conversions to larger bumper, order COC series (above) and COC brackets

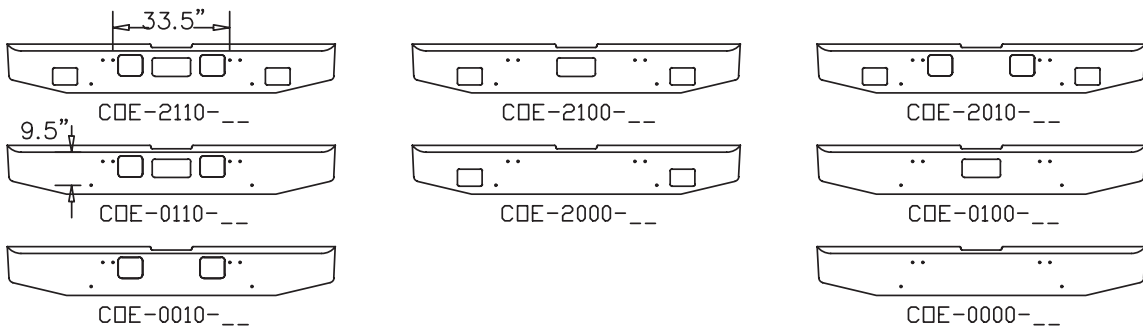



AVAILABLE STYLES (see page 7 for more styles)



Bumpers shown below are for MOUNTING and OPTIONS. To select a style use the two digit outside shape shown above as the last two digits of the part number.

### 1986-1995 FLC112 SET BACK AXLE W/16" break-back

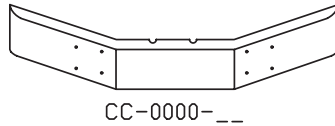
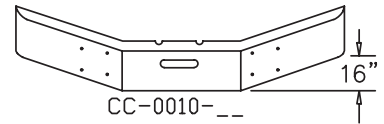
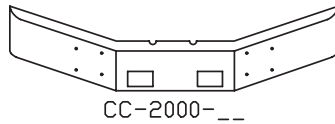
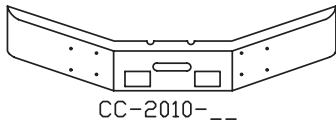

### 1986-1995 CONV. SET BACK AXLE W/17" break-back FLC 120 SERIES

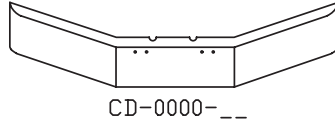
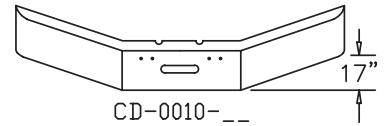
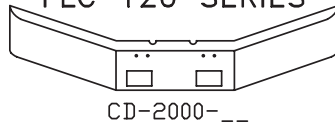
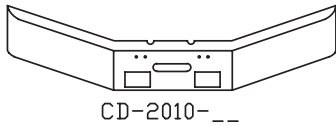

### 1989-1996 FLD 112 SEVERE DUTY SET BACK AXLE W/17" break-back

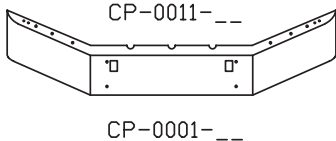
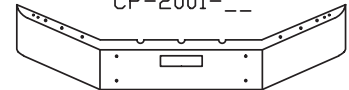
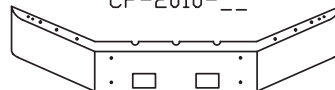
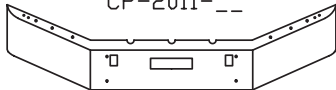
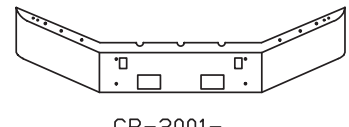
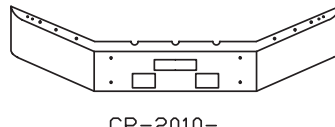
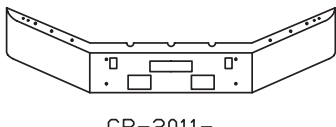

**No WARRANTY on break-backs over 18"**

## AVAILABLE STYLES (see page 7 for more styles)

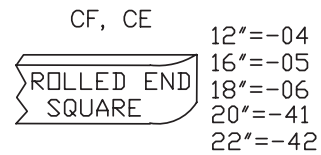
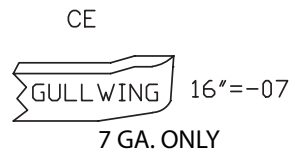
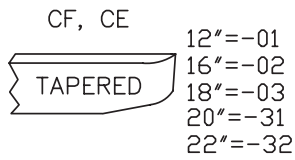

Bumpers shown below are for MOUNTING and OPTIONS. To select a style use the two digit outside shape shown above as the last two digits of the part number.

### 1989 - 1995 COE W/7" break - back (Not available in gullwing -07)

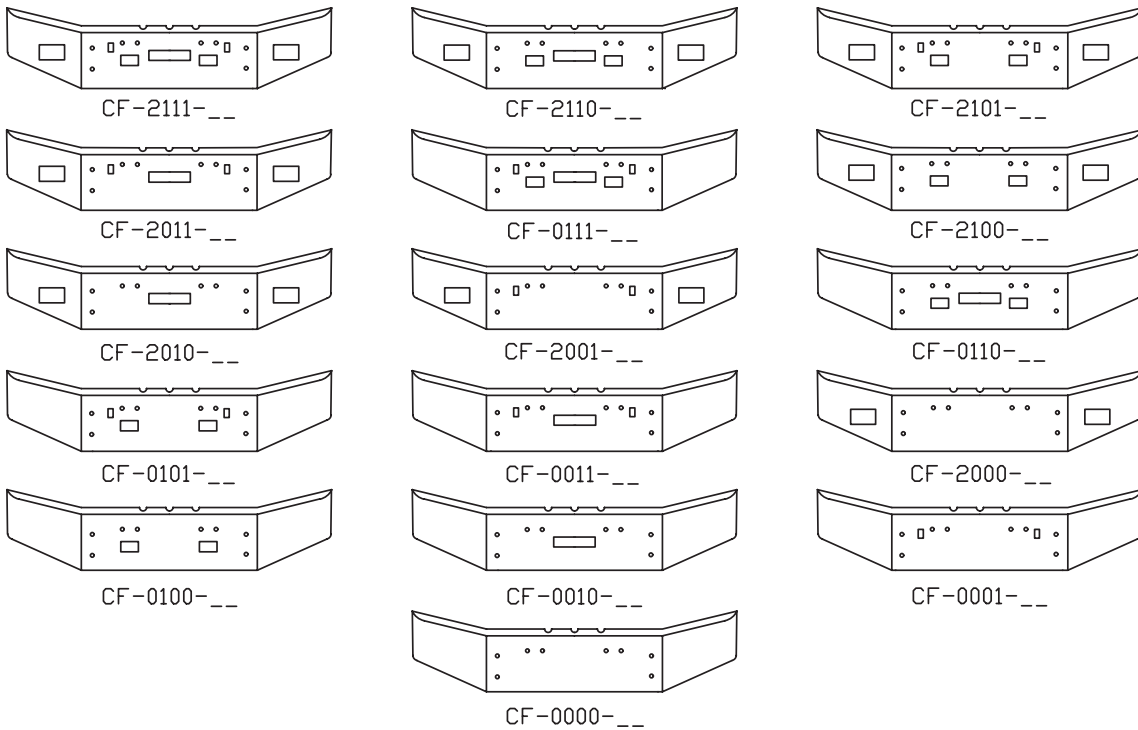

### 1989 - 1995 CONV. SET BACK AXLE W/2" break-back FLC 112 CONV. (STEEL CAB available in gullwing -07 only)

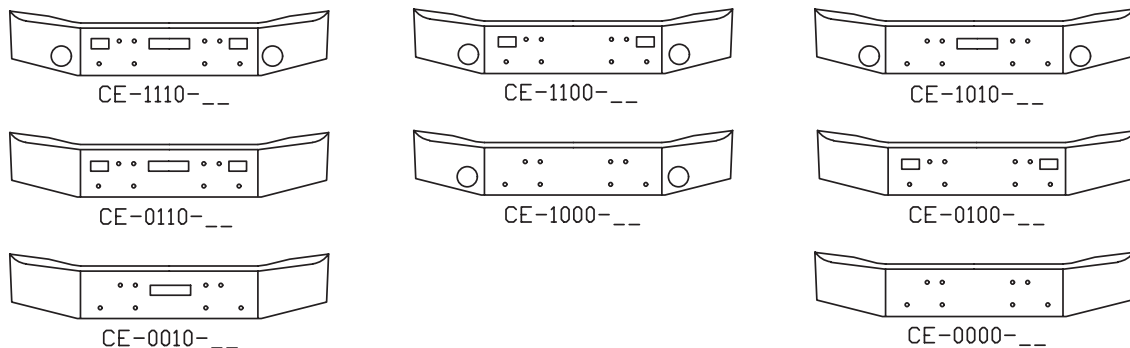

## AVAILABLE STYLES (see page 7 for more styles)

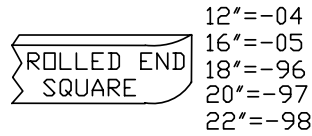

Bumpers shown below are for MOUNTING and OPTIONS. To select a style use the two digit outside shape shown above as the last two digits of the part number.

For full length 92" bumpers not using end caps, add "92" to end of part number.  
Example: CG-2011-04-"92"

### 1989 - 1996 FLD 112 W/6" break-back 86<sup>3</sup>/<sub>4</sub>" long use with factory plastic ends (not included)

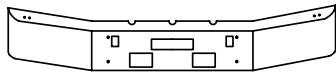

CG-2011-\_\_

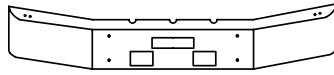

CG-2010-\_\_

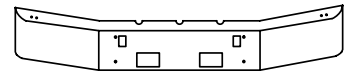

CG-2001-\_\_

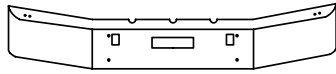

CG-0011-\_\_

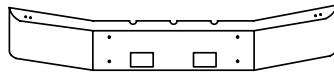

CG-2000-\_\_

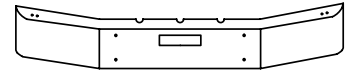

CG-0010-\_\_

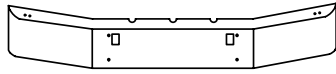

CG-0001-\_\_

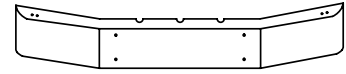

CG-0000-\_\_

### 1989 - 1996 FLD 120 W/6" break-back 86<sup>3</sup>/<sub>4</sub>" long use with factory plastic ends (not included) (please check next category before ordering)

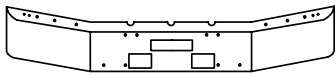

CH-2010-\_\_

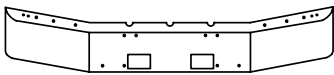

CH-2000-\_\_

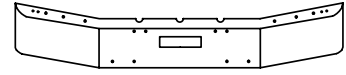

CH-0010-\_\_



CH-0000-\_\_

### 1989 - 1996 FLD 120 W/6" break-back 86<sup>3</sup>/<sub>4</sub>" long use with factory plastic ends (not included) (please check prior category before ordering)

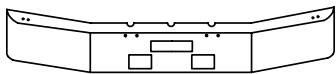

CJ-2010-\_\_

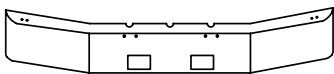

CJ-2000-\_\_

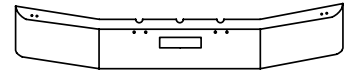

CJ-0010-\_\_

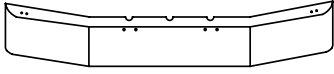

CJ-0000-\_\_

**No WARRANTY on break-backs over 18"**

AVAILABLE STYLES (see page 7 for more styles)



Bumpers shown below are for MOUNTING and OPTIONS. To select a style use the two digit outside shape shown above as the last two digits of the part number.

For full length 92" bumpers not using end caps, add "92" to end of part number.  
Example: CM-2011-04-"92"

1989 - 1996  
COMBINATION OF FLD 112 & FLD120 BOLT PATTERNS  
W/6" break-back

86<sup>3</sup>/<sub>4</sub>" long use with factory plastic ends (not included)

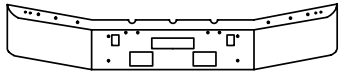

CM-2011-\_\_

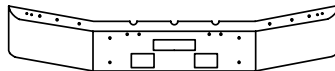

CM-2010-\_\_

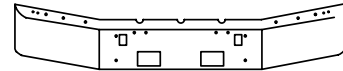

CM-2001-\_\_

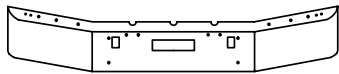

CM-0011-\_\_

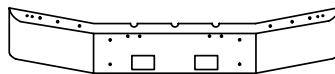

CM-2000-\_\_

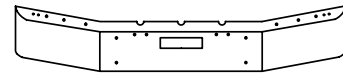

CM-0010-\_\_

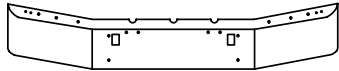

CM-0001-\_\_

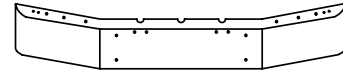

CM-0000-\_\_

No WARRANTY on break-backs over 18"



W I N G M A S T E R



## AVAILABLE STYLES (see page 7 for more styles)

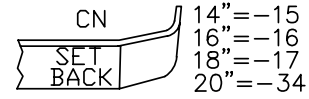
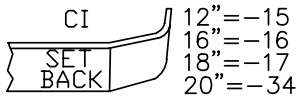

Bumpers shown below are for MOUNTING and OPTIONS. To select a style use the two digit outside shape shown above as the last two digits of the part number.

### 1989 - 1996 CONVENTIONAL SET BACK AXLE (Chrome Replacement) FLD 112, FLD120 (brackets included)

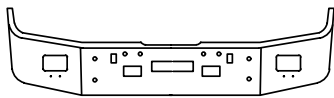

CI-2111-\_\_

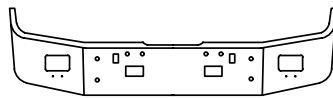

CI-2110-\_\_

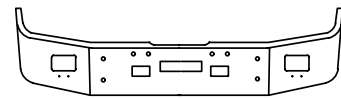

CI-2101-\_\_

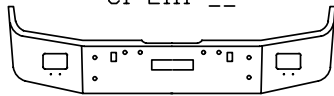

CI-2011-\_\_

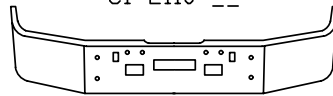

CI-0111-\_\_

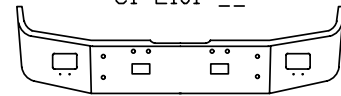

CI-2100-\_\_

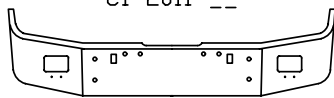

CI-2010-\_\_

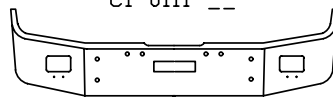

CI-2001-\_\_

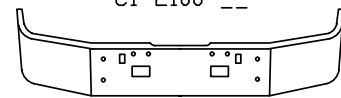

CI-0110-\_\_

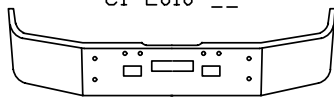

CI-0101-\_\_

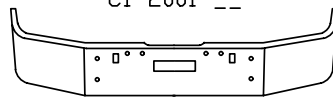

CI-0011-\_\_

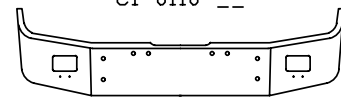

CI-2000-\_\_

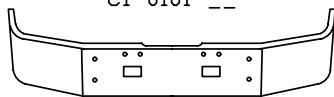

CI-0100-\_\_

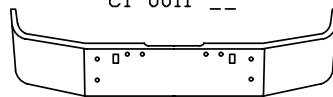

CI-0010-\_\_

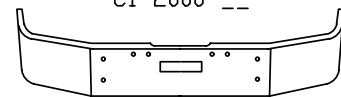

CI-0001-\_\_

Replacement Brackets, if needed:	
12" bumper	CI0115BK
16" bumper	CI0116BK
18" bumper	CI0117BK
20" bumper	CI0134BK

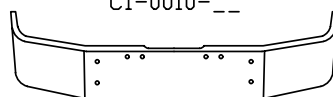

CI-0000-\_\_



### 1999 - 2003 COLUMBIA SET BACK AXLE (Chrome Replacement) (brackets included)

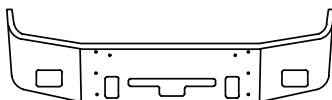

CN-2011-\_\_

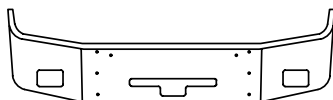

CN-2001-\_\_

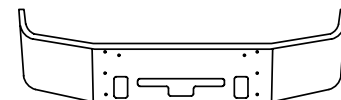

CN-0011-\_\_

Replacement Brackets, if needed:	
14" bumper	CN0115BK
16" bumper	CN0116BK
18" bumper	CN0117BK
20" bumper	CN0134BK

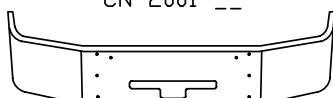

CN-0001-\_\_



**No WARRANTY on break-backs over 18"**

## AVAILABLE STYLES (see page 7 for more styles)

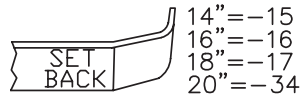

Bumpers shown below are for MOUNTING and OPTIONS. To select a style use the two digit outside shape shown above as the last two digits of the part number.

### CONVENTIONAL SET BACK AXLE (Chrome Replacement) 1996-2004 CENTURY CLASS (Brackets Included)

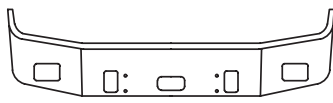

CL-2210-\_\_

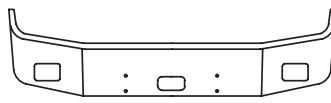

CL-2200-\_\_

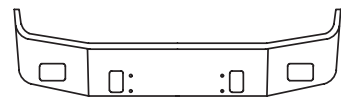

CL-2010-\_\_

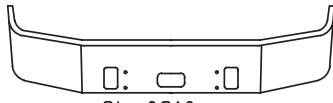

CL-0210-\_\_



CL-0200-\_\_

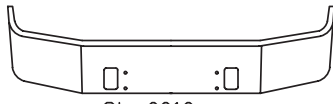

CL-0010-\_\_

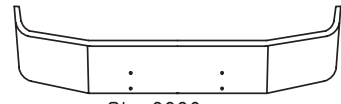

CL-0000-\_\_

Replacement Brackets, if needed:	
14" bumper	CL0115BK
16" bumper	CL0116BK
18" bumper	CL0117BK
20" bumper	CL0134BK

**No WARRANTY on break-backs over 18"**

### CONVENTIONAL SET BACK AXLE (Chrome Replacement) 2005-2007 CENTURY CLASS (Brackets Included)

2004-2007 COLUMBIA

ALSO FITS NEWER MODEL GLIDERS - CHECK CHASSIS MOUNTING

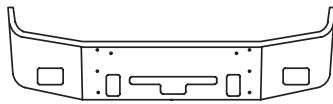

CW-2011-\_\_

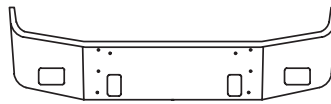

CW-2010-\_\_

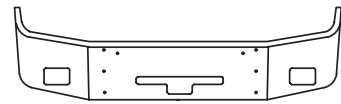

CW-2001-\_\_

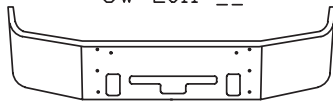

CW-0011-\_\_

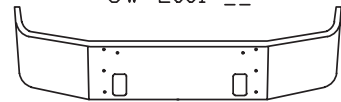

CW-0010-\_\_

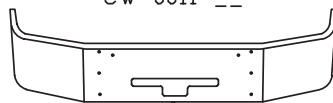

CW-0001-\_\_

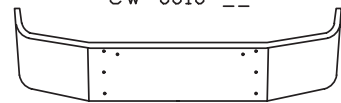

CW-0000-\_\_

Replacement Brackets, if needed:	
14" bumper	CW0115BK
16" bumper	CW0116BK
18" bumper	CW0117BK
20" bumper	CW0134BK

**No WARRANTY on break-backs over 18"**

AVAILABLE STYLES (see page 7 for more styles)

COA, COB are not available in 12" or 16"

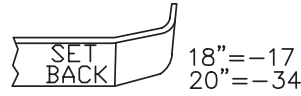

Bumpers shown below are for MOUNTING and OPTIONS. To select a style use the two digit outside shape shown above as the last two digits of the part number.

CONVENTIONAL SET BACK AXLE (Replaces Plastic Only)  
2008 AND NEWER COLUMBIA (Brackets Included)  
(for glider check CW series)

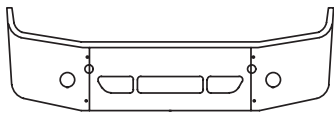

COA-1011-\_\_

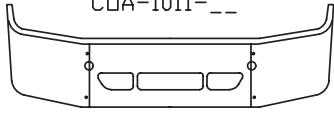

COA-0011-\_\_

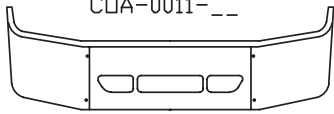

COA-0001-\_\_

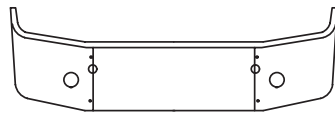

COA-1010-\_\_



COA-0011-17

AIR FOIL



COA-AF

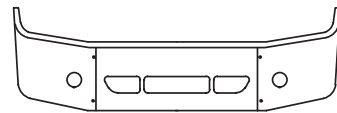

COA-1001-\_\_

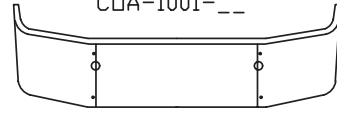

COA-0010-\_\_

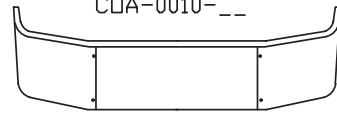

COA-0000-\_\_

Replacement Brackets, if needed:	
18" bumper	COA0117BK
20" bumper	COA0134BK

**No WARRANTY on break-backs over 18"**

CONVENTIONAL SET BACK AXLE (Chrome Replacement)  
2008 AND NEWER CENTURY CLASS (Brackets Included)  
2008 & NEWER COLUMBIA (Replaces Stainless Clad, Brkts Included)

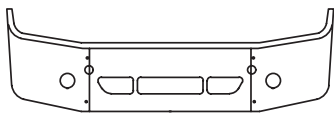

COB-1011-\_\_

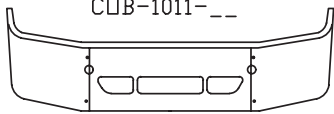

COB-0011-\_\_

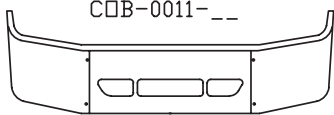

COB-0001-\_\_

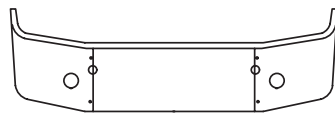

COB-1010-\_\_

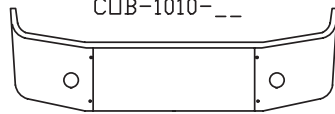

COB-1000-\_\_



COB-0011-17

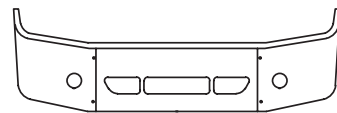

COB-1001-\_\_

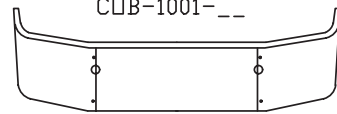

COB-0010-\_\_

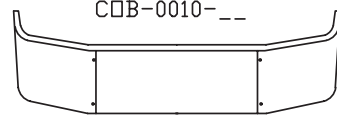

COB-0000-\_\_

Replacement Brackets, if needed:	
18" bumper	COB0117BK
20" bumper	COB0134BK

**No WARRANTY on break-backs over 18"**

## AVAILABLE STYLES (see page 7 for more styles)

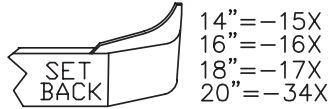

Bumpers shown below are for MOUNTING and OPTIONS. To select a style use the two digit outside shape shown above as the last two digits of the part number.

### CONVENTIONAL SET BACK AXLE (Replaces Plastic) 2008-2017 CASCADIA (Brackets Included) "P3" 3PC. BUMPER (extensions included, fits factory air dam) 1400 SQ. INCH RADIATOR TRUCKS ONLY

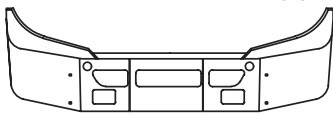

CY-2011-\_\_

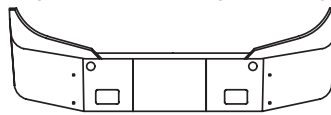

CY-2010-\_\_

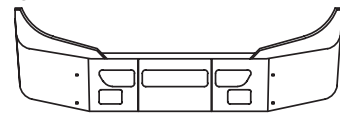

CY-2001-\_\_

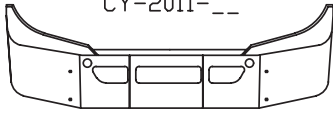

CY-0011-\_\_

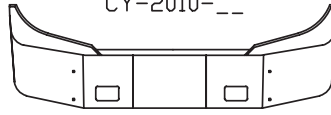

CY-2000-\_\_

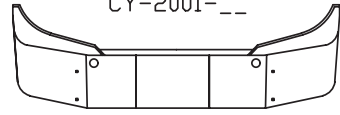

CY-0010-\_\_

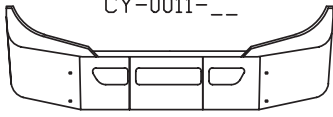

CY-0001-\_\_

Replacement Brackets, if needed:	
14" bumper	CY0215BK
16" bumper	CY0216BK
18" bumper	CY0217BK
20" bumper	CY0234BK
Replacement Extensions, if needed:	
Includes hardware	CYEXT

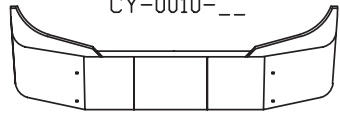

CY-0000-\_\_

**NOTE: OLDER DESIGN FLANGE - MOUNT BRACKETS**  
14" = CY0115BK, 16" = CY0116BK, ETC.

(shown with factory lights and wide vent for onguard radar)

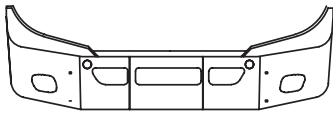

CY-5011-\_\_



CY-5012-15X



CY-AF

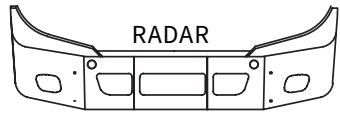

CY-5012-\_\_

### 2008-2017 CASCADIA (mounts to factory brackets) "P3" (Replaces Stainless Clad - brackets not included) 3PC. BUMPER (extensions included, fits factory air dam) 1400 SQ. INCH RADIATOR TRUCKS ONLY

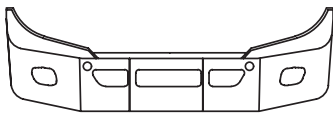

CDH-5011-\_\_

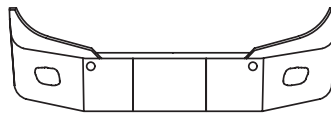

CDH-5010-\_\_

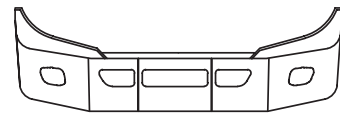

CDH-5001-\_\_

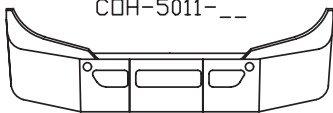

CDH-0011-\_\_

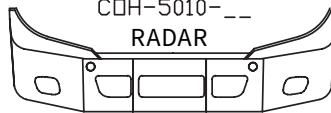

CDH-5012-\_\_

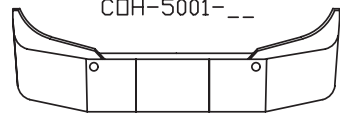

CDH-0010-\_\_

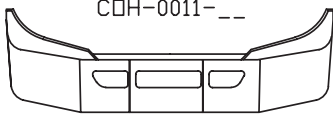

CDH-0001-\_\_



AIR FOIL

CDH-AF

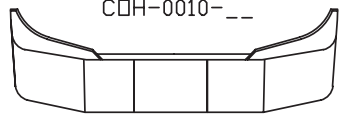

CDH-0000-\_\_

**No WARRANTY on break-backs over 18"**

## AVAILABLE STYLES (see page 7 for more styles)

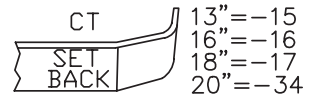
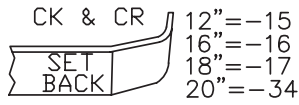

Bumpers shown below are for MOUNTING and OPTIONS. To select a style use the two digit outside shape shown above as the last two digits of the part number.

### 2002 AND OLDER FL 50, 60, 70, 80, (midrange)

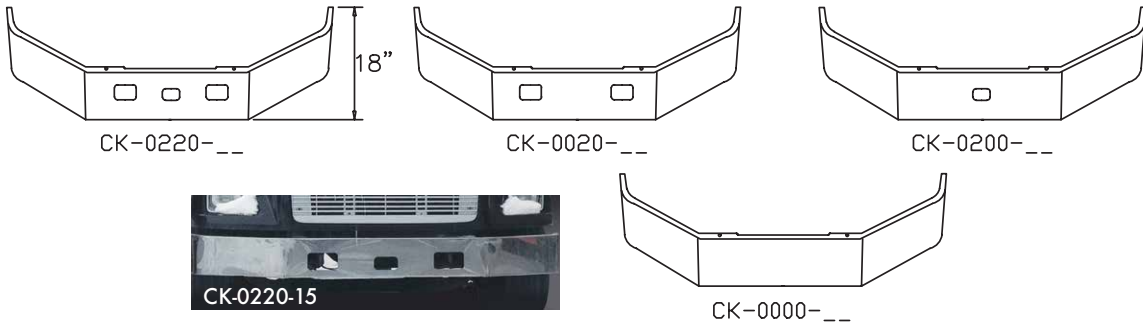

### 2002 AND OLDER FL112 (midrange) (Ends are 6" Longer than CK Model Check before ordering)

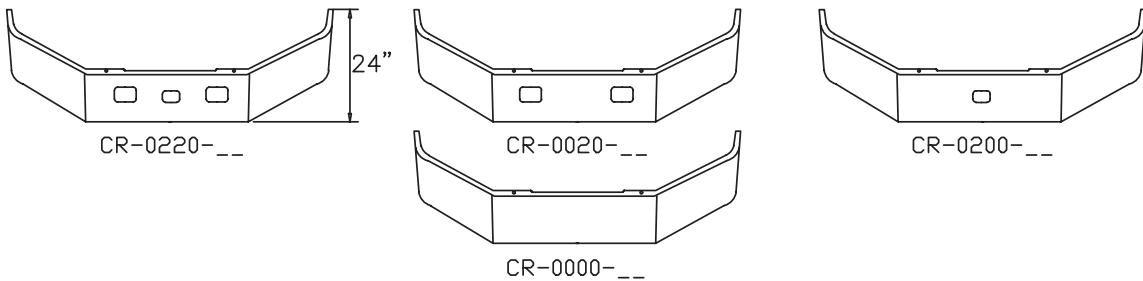

### 2003 AND NEWER BUSINESS CLASS M2 106 (midrange) FLUSH TOP FLANGE MOUNT – ALSO SEE COG SERIES NEXT PAGE PRIOR TO ORDERING



**No WARRANTY on break-backs over 18"**

## AVAILABLE STYLES (see page 7 for more styles)

COF, COG



13"=-15  
16"=-16  
18"=-17  
20"=-34

COJ



14"=-15Z  
16"=-16Z  
18"=-17Z  
20"=-34Z

Bumpers shown below are for MOUNTING and OPTIONS. To select a style use the two digit outside shape shown above as the last two digits of the part number.

### 2003 & NEWER BUSINESS CLASS M2 112 (midrange)

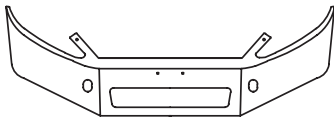

CDF-0011-\_\_

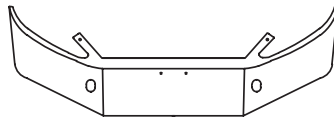

CDF-0010-\_\_

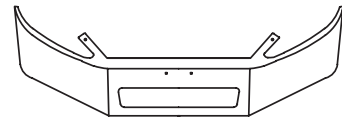

CDF-0001-\_\_



COF-0011-15

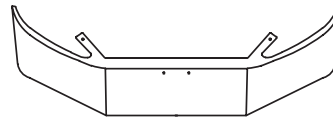

CDF-0000-\_\_

No WARRANTY on break-backs over 18"

### 2011 AND NEWER BUSINESS CLASS M2 106 (midrange) (COGmount brackets included & shown)

RECESSED TOP FLANGE MOUNT – ALSO SEE CT SERIES PREVIOUS PAGE PRIOR TO ORDERING

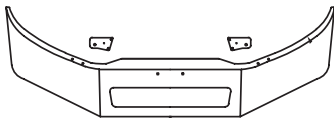

COG-0001-\_\_

No WARRANTY on break-backs over 18"

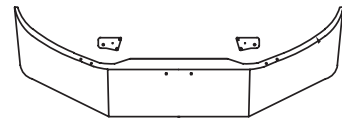

COG-0000-\_\_

### 2017 AND NEWER CASCADIA (Brackets Included)

3PC. BUMPER, TOW HOLES IN EXTENSIONS

REPLACES COMPOSITE BUMPERS

WILL NOT FIT FRAMES WITH WIDE RADIATORS

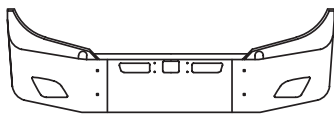

COJ-5011-\_\_-V6

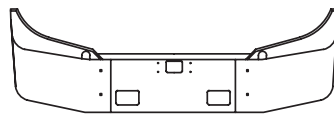

COJ-2010-\_\_-V6

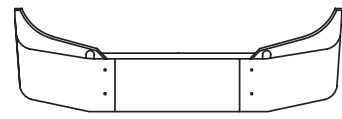

COJ-0010-\_\_

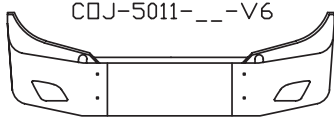

COJ-5010-\_\_

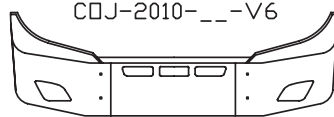

COJ-5001-\_\_

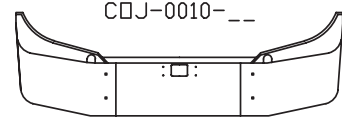

COJ-0010-\_\_-V6

V6 = RADAR WITH PLASTIC COVER

FOR CLAD BUMPER REPLACEMENT ORDER BRACKETS COJ0215BK





COJ-5010-15Z-V6

No WARRANTY on break-backs over 18"

\* COLLISION MITIGATION RADAR REQUIRES OEM  
PLASTIC COVER RE INSTALLED ON VALLEY CHROME BUMPER



AVAILABLE STYLES (see page 7 for more styles)

 <p>TAPERED</p>	12"=-01	 <p>BOXED END</p>	12"=-09	 <p>ROLLED END SQUARE</p>	12"=-04
	16"=-02		16"=-10		16"=-05
	18"=-03		18"=-11		18"=-06
	20"=-31		20"=-51		20"=-41
	22"=-32		22"=-52		22"=-42

Bumpers shown below are for MOUNTING and OPTIONS. To select a style use the two digit outside shape shown above as the last two digits of the part number.

**1977 - 1987 GENERAL**

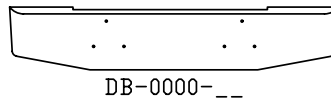
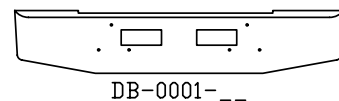
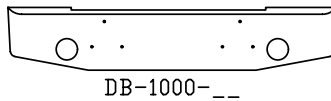
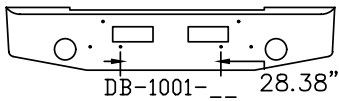

**1978 - 1988 BRIGADIER**

(please check next category and measurements before ordering)  
(not available in 12" width)

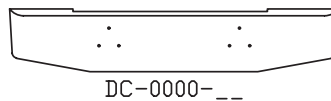
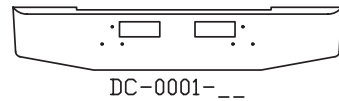
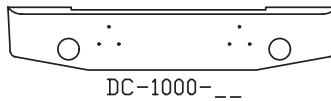
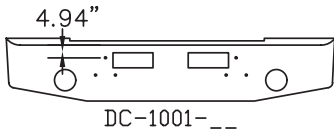

**1978 - 1988 BRIGADIER HIGH CAB**

(please check prior category and measurements before ordering)

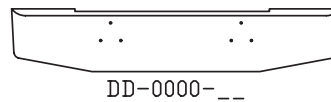
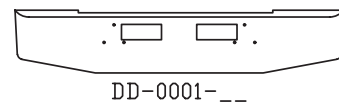
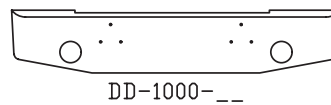
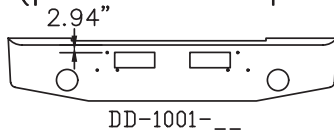

## AVAILABLE STYLES (see page 7 for more styles)

DF, DG	DE	12"=-01	DE	12"=-09	DE	12"=-04
FACTORY STYLE	TAPERED	16"=-02	BOXED END	16"=-10	ROLLED END	16"=-05
14"=-38		18"=-03		18"=-11	SQUARE	18"=-06
		20"=-31		20"=-51		20"=-41
		22"=-32		22"=-52		22"=-42

Bumpers shown below are for MOUNTING and OPTIONS. To select a style use the two digit outside shape shown above as the last two digits of the part number.

### 1982-1987 ASTRO (not available in 12" width)

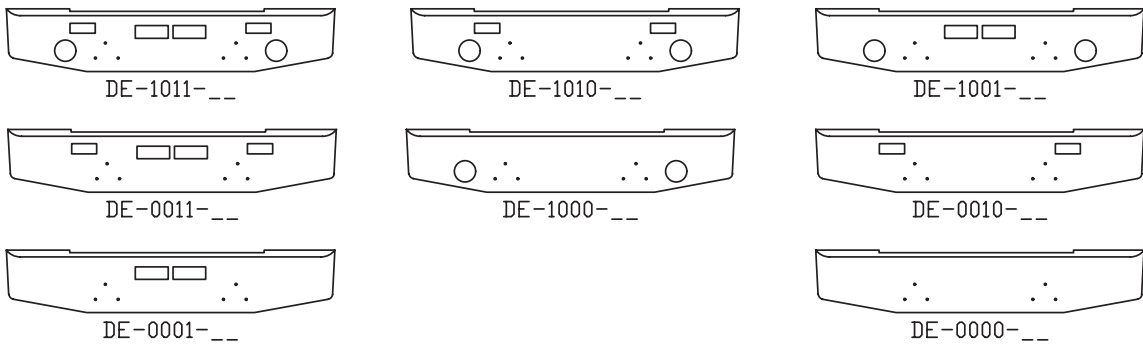

### 1989-1990 GMC TOPKICK / CHEVY KODIAK (Prior to 1989 not available in -38 style) (not available in 7g or stainless steel)

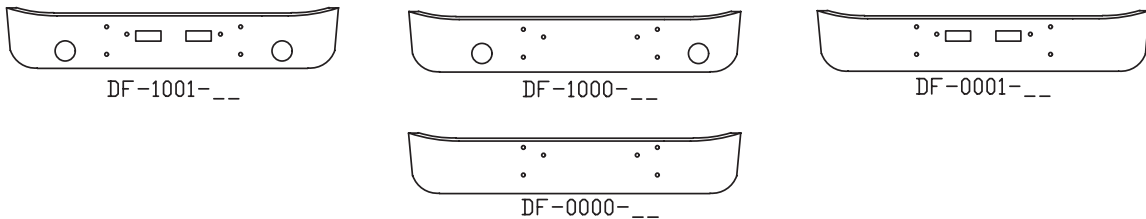

### 1990-2003 GMC TOPKICK / CHEVY KODIAK / C500, C6500 (not available in 7g or stainless steel)

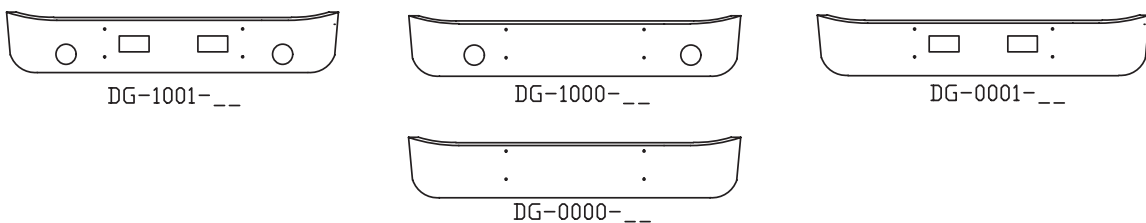

AVAILABLE STYLES (see page 7 for more styles)

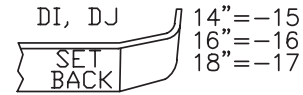
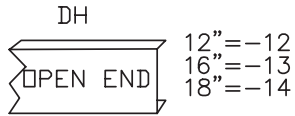

Bumpers shown below are for MOUNTING and OPTIONS. To select a style use the two digit outside shape shown above as the last two digits of the part number.

1981 - 1988 GMC 7000, CHEVY C60, C65, C70 W/7" break-back

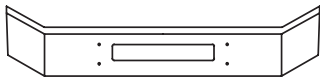

DH-0001-\_\_

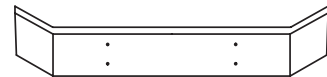

DH-0000-\_\_

2004 - 2006 GMC C4500, C5500

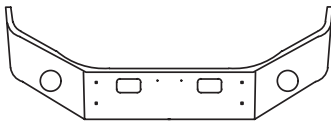

DI-1001-\_\_

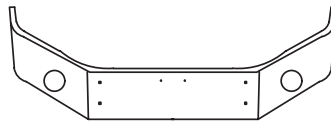

DI-1000-\_\_

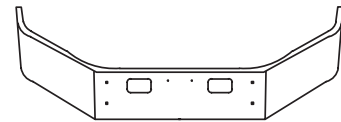

DI-0001-\_\_

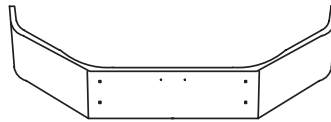

DI-0000-\_\_

2004 - 2009 GMC 6500, 7500

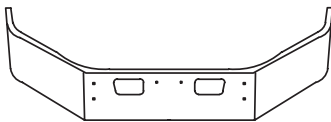

DJ-0001-\_\_

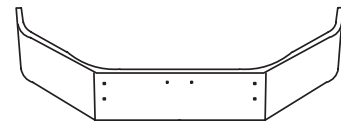

DJ-0000-\_\_



DI-0001-15



DJ-0001-15

**No WARRANTY on break-backs over 18"**

## AVAILABLE STYLES (see page 7 for more styles)

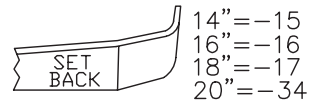

Bumpers shown below are for MOUNTING and OPTIONS. To select a style use the two digit outside shape shown above as the last two digits of the part number.

### MODELS 268, 338

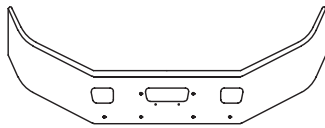

OA-0011-\_\_

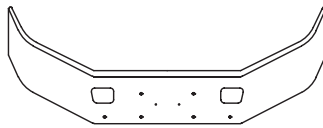

OA-0010-\_\_

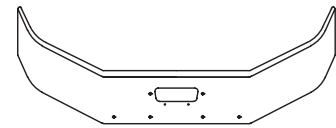

OA-0001-\_\_

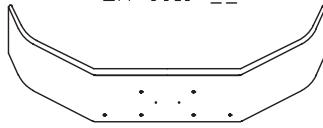

OA-0000-\_\_



**No WARRANTY on break-backs over 18"**

## AVAILABLE STYLES (see page 7 for more styles)

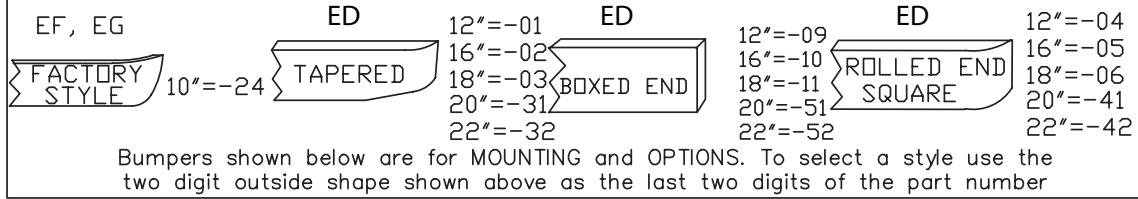

### 1977 - 1990 CONV. 4200, 4300

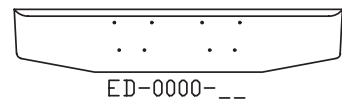
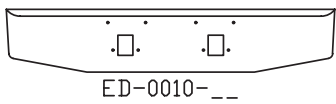
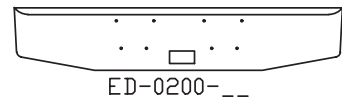
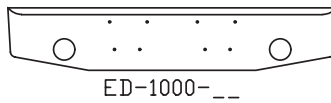
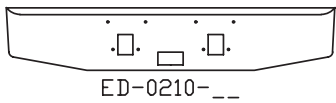
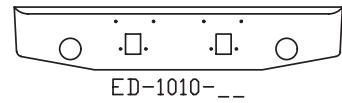
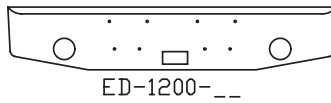
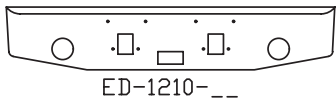

### 1977 - 1990 MODELS 2200, 2500 S (not available in 10g or stainless steel)

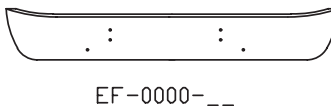
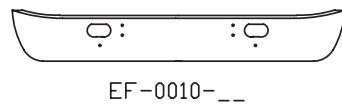
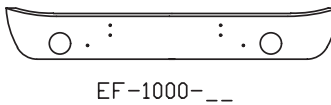
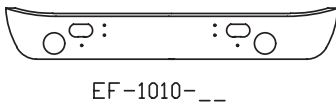

### 1977 - 1990 MODELS 1700, 1800, 1900 S (not available in 10g or stainless steel)

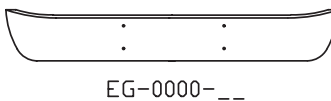
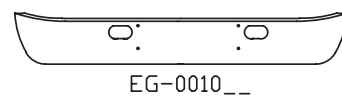
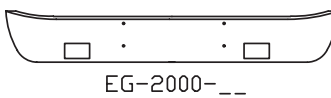
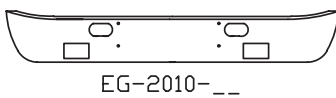

## AVAILABLE STYLES (see page 7 for more styles)

EI	12"=-01	EI, EJ	12"=-09	EJ	12"=-04	EI	12"=-04
TAPERED	16"=-02	BOXED END	16"=-10	ROLLED END SQUARE	16"=-05	ROLLED END SQUARE	16"=-05
	18"=-03		18"=-11		18"=-96		18"=-06
	20"=-31		20"=-51		20"=-97		20"=-41
	22"=-32		22"=-52		22"=-98		22"=-42
	Bumpers shown below are for MOUNTING and OPTIONS. To select a style use the two digit outside shape shown above as the last two digits of the part number						

### 1983 - 1996 COE 9670, CONV. 9370, 9300

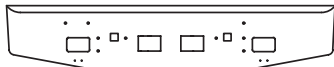

EI-2110-\_\_



EI-2210-\_\_



EI-2100-\_\_

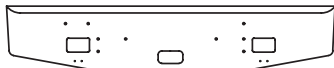

EI-2200-\_\_



EI-2010-\_\_

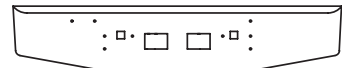

EI-0110-\_\_



EI-0210-\_\_



EI-2000-\_\_

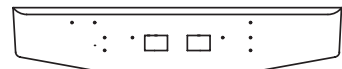

EI-0100-\_\_

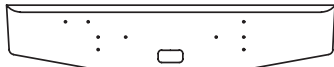

EI-0200-\_\_

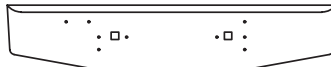

EI-0010-\_\_

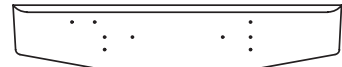

EI-0000-\_\_

### 1983 - 1996 CONV. 9300 SERIES SET BACK AXLE W/5" break-back (Rolled End Square -96, 97, 98 Hand Formed)

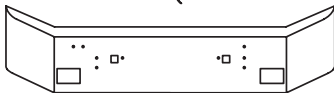

EJ-2010-\_\_

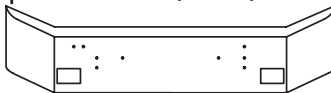

EJ-2000-\_\_

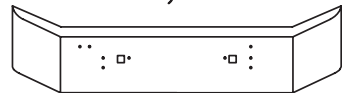

EJ-0010-\_\_

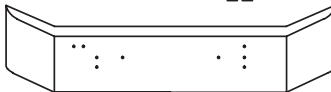

EJ-0000-\_\_

**No WARRANTY on break-backs over 18"**



## AVAILABLE STYLES (see page 7 for more styles)

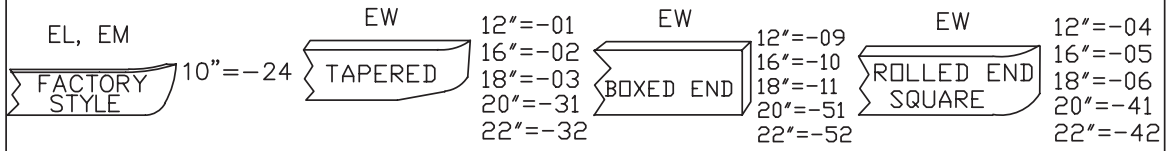

Bumpers shown below are for MOUNTING and OPTIONS. To select a style use the two digit outside shape shown above as the last two digits of the part number

### 1990 - 2004 MIDRANGE 4600,4700,4800,4900,7100,8100,8200,8300 (not available in 10g steel or stainless steel)

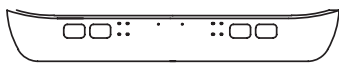

EL-2010-\_\_

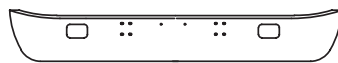

EL-2000-\_\_

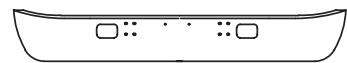

EL-0010-\_\_



EL-0000-\_\_

### 1990 - 2004 MIDRANGE 4600, 4700, 4800, 4900, 7100, 8100, 8300 (not available in 10g steel or stainless steel)

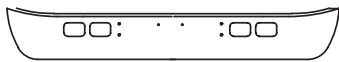

EM-2010-\_\_

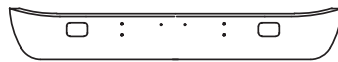

EM-2000-\_\_

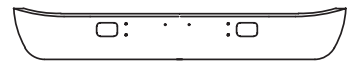

EM-0010-\_\_

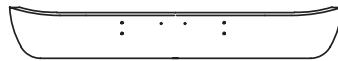

EM-0000-\_\_

### 2001-2011 5900I



EW-2010-\_\_



EW-2020-\_\_



EW-2030-\_\_



EW-2000-\_\_



EW-0010-\_\_



EW-0020-\_\_

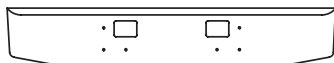

EW-0030-\_\_



EW-2010-02

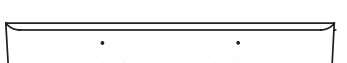

EW-0000-\_\_

## AVAILABLE STYLES (see page 7 for more styles)

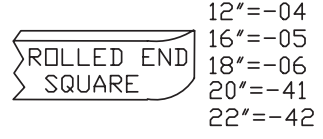
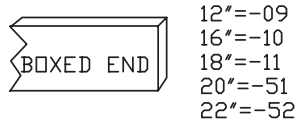
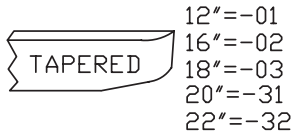

Bumpers shown below are for MOUNTING and OPTIONS. To select a style use the two digit outside shape shown above as the last two digits of the part number

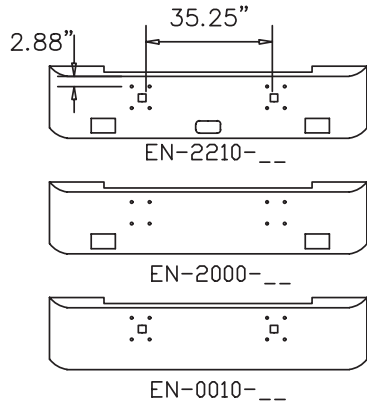

### 1998-1999 EAGLE 9900

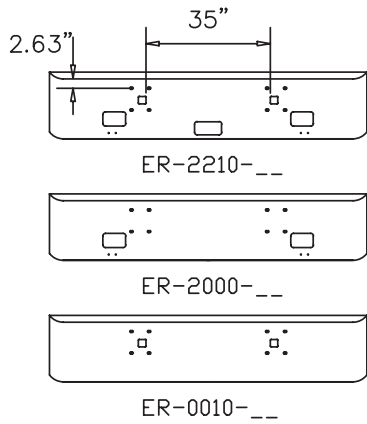
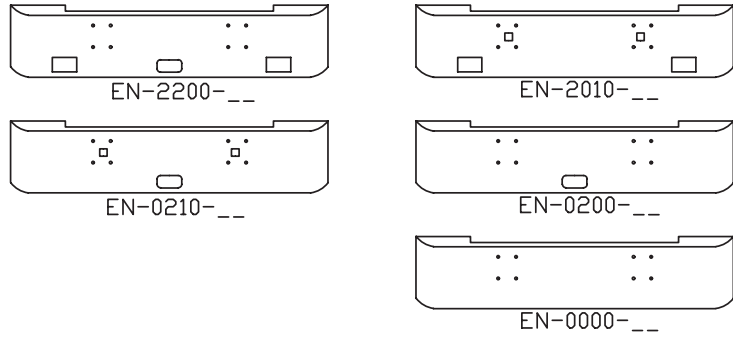

### 2000 AND NEWER 9900 IX

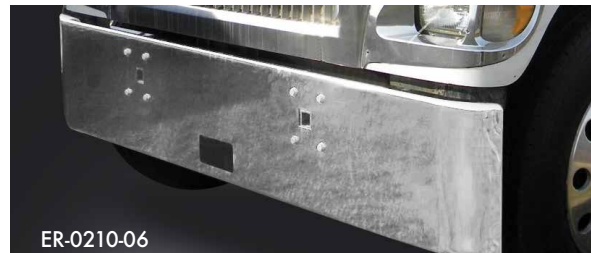
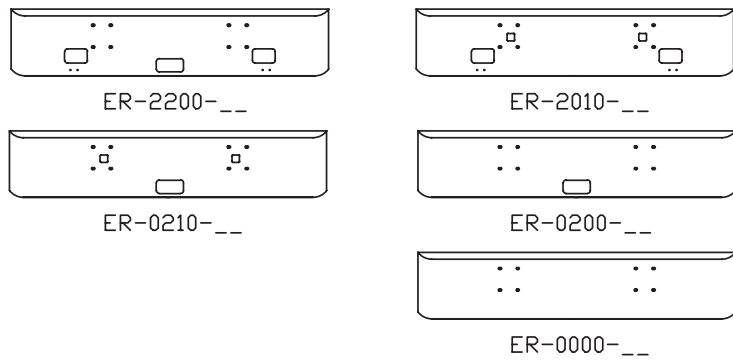

AVAILABLE STYLES (see page 7 for more styles)

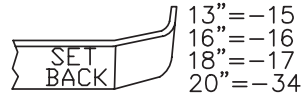

Bumpers shown below are for MOUNTING and OPTIONS. To select a style use the two digit outside shape shown above as the last two digits of the part number

### 1990 – 1996 CONV. 9400 SET BACK AXLE

(check EP series before ordering)

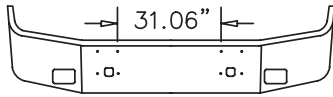

EK-2010-\_\_

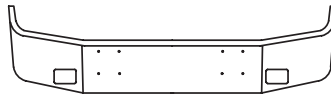

EK-2000-\_\_

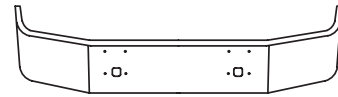

EK-0010-\_\_

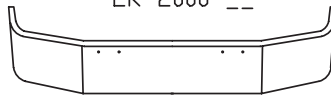

EK-0000-\_\_

### 1997 – 2007 MODELS 9100, 9200, 9400

(check EK series before ordering)

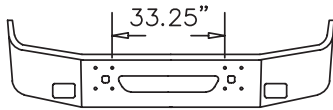

EP-2011-\_\_

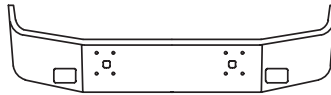

EP-2010-\_\_

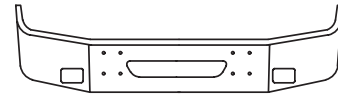

EP-2001-\_\_



EP-0011-\_\_

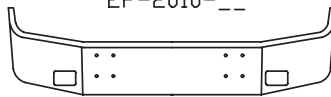

EP-2000-\_\_

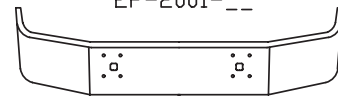

EP-0010-\_\_

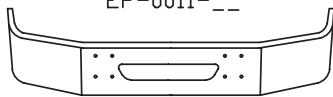

EP-0001-\_\_

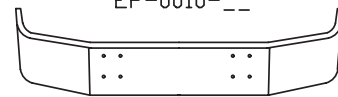

EP-0000-\_\_

### 1992 – 1996 MODEL 9200

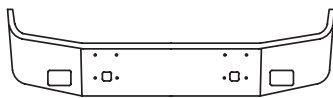

ES-2010-\_\_

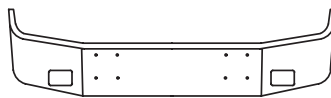

ES-2000-\_\_

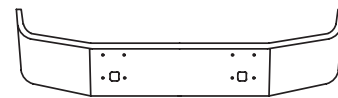

ES-0010-\_\_

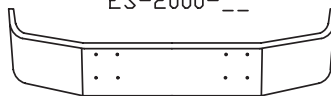

ES-0000-\_\_

**No WARRANTY on break-backs over 18"**

AVAILABLE STYLES (see page 7 for more styles)



Bumpers shown below are for MOUNTING and OPTIONS. To select a style use the two digit outside shape shown above as the last two digits of the part number

2008-2017 PROSTAR (fixed mount non tilt, brackets Included)

3PC. BUMPER (extensions included, fits factory air dam)

USE OPTION CODE - V8 FOR RECTANGULAR FRONT RADAR

USE OPTION CODE - V9 FOR ROUND FRONT RADAR

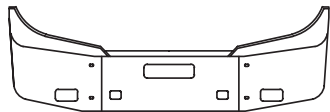

EU-5011-\_\_X



EU-5010-\_\_X



EU-5001-\_\_X

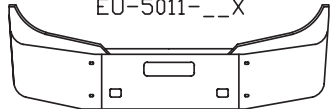

EU-0011-\_\_X

Replacement Brackets, if needed:	
16" bumper	EU0116BK
18" bumper	EU0117BK
20" bumper	EU0134BK
Replacement Extensions, if needed:	
Includes hardware	EU-EXT

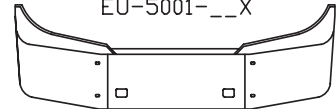

EU-0010-\_\_X

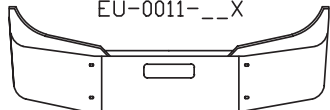

EU-0001-\_\_X

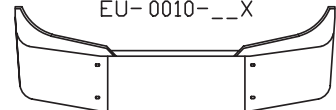

EU-0000-\_\_X



AIR FOIL

EU-AF



EU-5011-16X



EY-5013-16X

2017 AND NEWER LT SERIES (Chrome Replacement, brackets Included)

3PC. BUMPER (extensions included)

REPLACES PLASTIC BUMPER ONLY



EY-5013-\_\_X



EY-2011-\_\_X



EY-2003-\_\_X

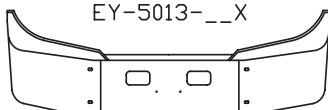

EY-5000-\_\_X



EY-0011-\_\_X

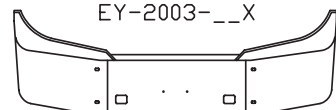

EY-0010-\_\_X

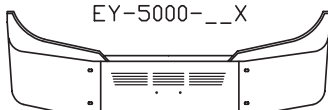

EY-0003-\_\_X



AIR FOIL

EY-AF

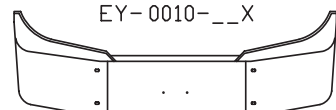

EY-0000-\_\_X

No WARRANTY on break-backs over 18"

AVAILABLE STYLES (see page 7 for more styles)



Bumpers shown below are for MOUNTING and OPTIONS. To select a style use the two digit outside shape shown above as the last two digits of the part number

2002 & NEWER 4000 SERIES DURASTAR DT466  
(mounting brackets included, automatic must have vent hole)

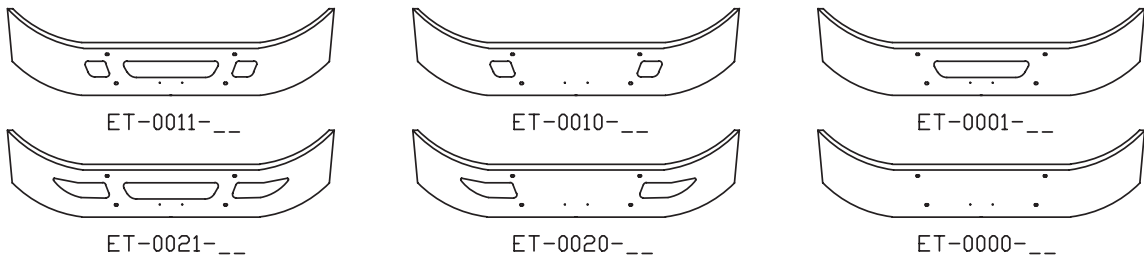

2006 & NEWER 7000 SERIES DT466 (available in -38 or -15)  
(-38 not available in 7g or stainless steel)

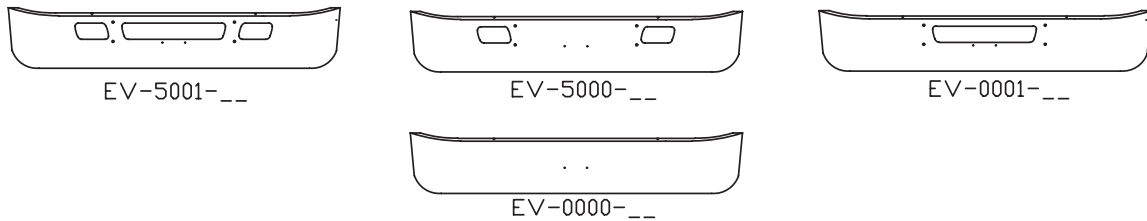

**No WARRANTY on break-backs over 18"**

## AVAILABLE STYLES (see page 7 for more styles)

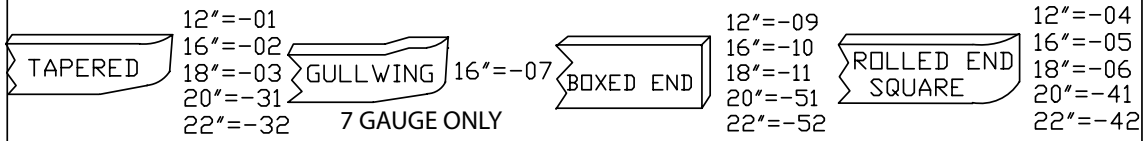

Bumpers shown below are for MOUNTING and OPTIONS. To select a style use the two digit outside shape shown above as the last two digits of the part number

### 1967-1983 COE K100C



FA-1110-\_\_



FA-1100-\_\_

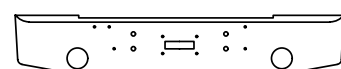

FA-1010-\_\_

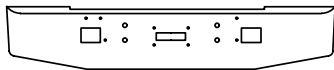

FA-0110-\_\_

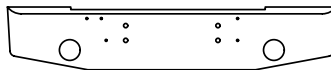

FA-1000-\_\_

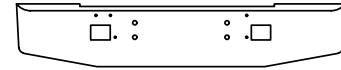

FA-0100-\_\_



FA-0010-\_\_

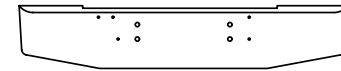

FA-0000-\_\_

### 1984-1999 COE K100E

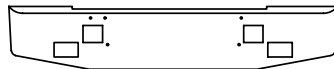

FB-2010-\_\_

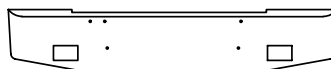

FB-2000-\_\_

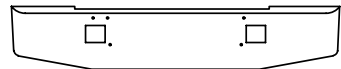

FB-0010-\_\_

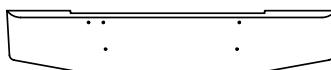

FB-0000-\_\_

### 1967-1981 CONV. W900A

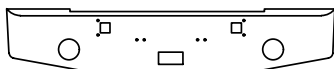

FD-1210-\_\_

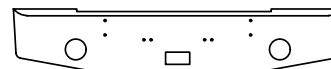

FD-1200-\_\_

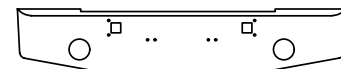

FD-1010-\_\_

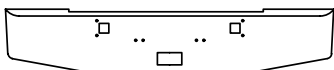

FD-0210-\_\_

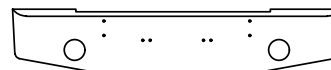

FD-1000-\_\_



FD-0200-\_\_

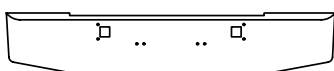

FD-0010-\_\_

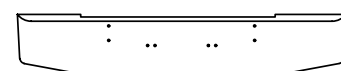

FD-0000-\_\_

## AVAILABLE STYLES (see page 7 for more styles)

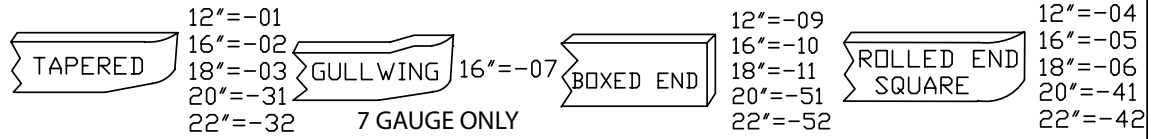

Bumpers shown below are for MOUNTING and OPTIONS. To select a style use the two digit outside shape shown above as the last two digits of the part number

### 1982 – 2010 CONV. W900B 1982 – NEWER CONV. W900L

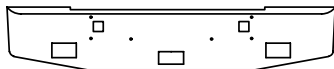

FE-2210-\_\_



FE-2200-\_\_

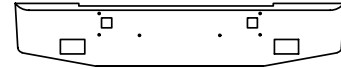

FE-2010-\_\_

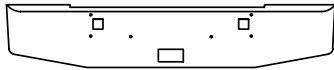

FE-0210-\_\_

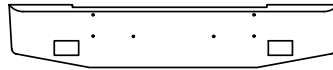

FE-2000-\_\_

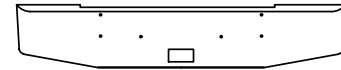

FE-0200-\_\_

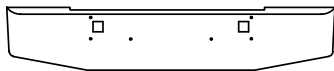

FE-0010-\_\_



FE-0210-02

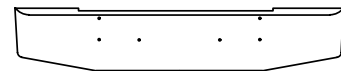

FE-0000-\_\_

### 2011 AND NEWER CONV. W900B ONLY

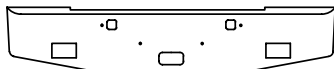

FT-2210-\_\_



FT-2200-\_\_

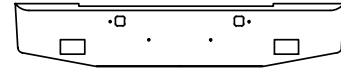

FT-2010-\_\_



FT-0210-\_\_

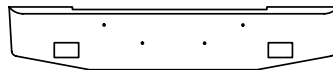

FT-2000-\_\_

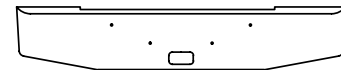

FT-0200-\_\_

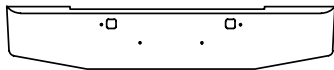

FT-0010-\_\_



FT-0210-06

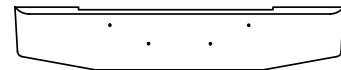

FT-0000-\_\_

### 1967 – 1981 LOGGER

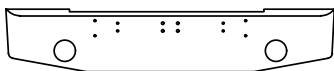

FF-1090-\_\_



FF-1000-\_\_

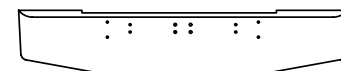

FF-0090-\_\_

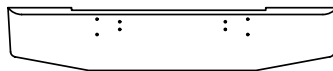

FF-0000-\_\_



## AVAILABLE STYLES (see page 7 for more styles)

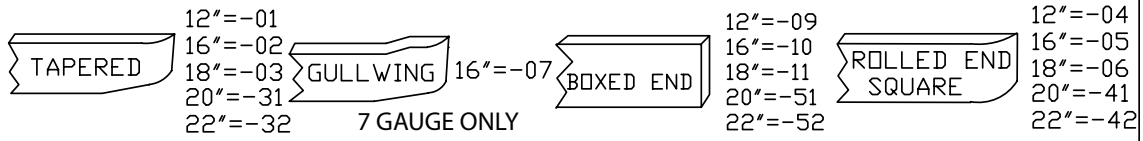

Bumpers shown below are for MOUNTING and OPTIONS. To select a style use the two digit outside shape shown above as the last two digits of the part number

### 1989 - 2007 W900S (Standard Width 12")

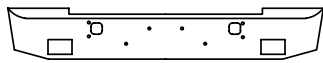

FJ-2010-\_\_

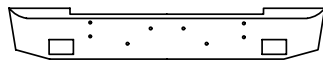

FJ-2000-\_\_

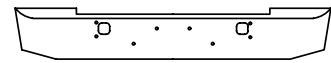

FJ-0010-\_\_

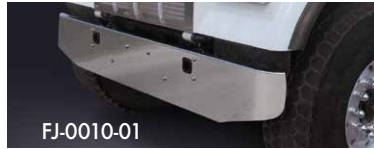

FJ-0010-01

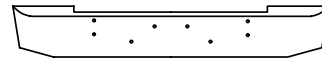

FJ-0000-\_\_

### 2019 AND NEWER W990

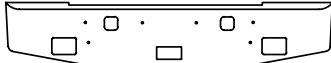

FQ-2210-\_\_

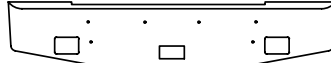

FQ-2200-\_\_

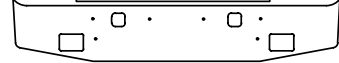

FQ-2010-\_\_

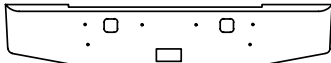

FQ-0210-\_\_

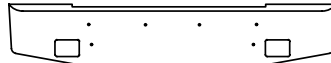

FQ-2000-\_\_

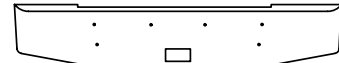

FQ-0200-\_\_

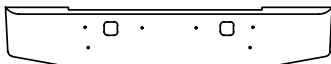

FQ-0010-\_\_

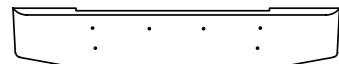

FQ-0000-\_\_

### 2019 AND NEWER W990

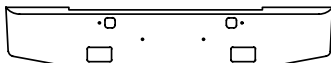

HV-2010-\_\_

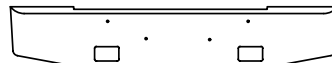

HV-2000-\_\_

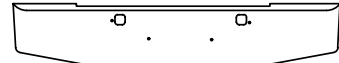

HV-0010-\_\_

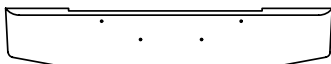

HV-2000-\_\_



HV-0210-06



HV-0090-\_\_

Also fits certain common chassis Peterbilt models, see page 54

## AVAILABLE STYLES (see page 7 for more styles)

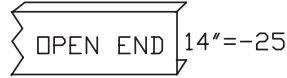

Bumpers shown below are for MOUNTING and OPTIONS. To select a style use the two digit outside shape shown above as the last two digits of the part number

### 1986-2003 T800 CONV. W/7" break-back (90" long)

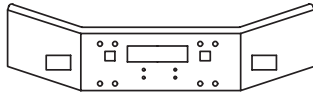

FG-2191-\_\_

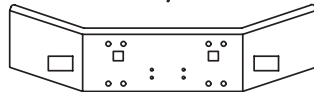

FG-2190-\_\_

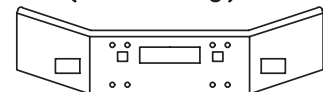

FG-2101-\_\_

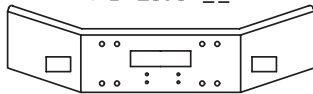

FG-2091-\_\_

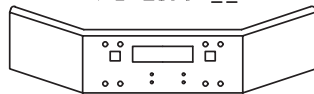

FG-0191-\_\_

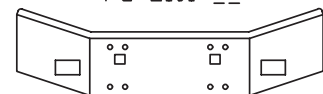

FG-2100-\_\_

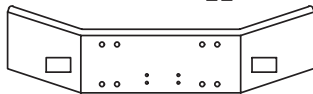

FG-2090-\_\_

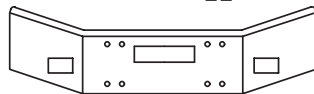

FG-2001-\_\_

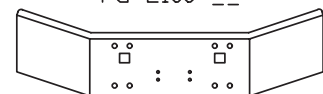

FG-0190-\_\_

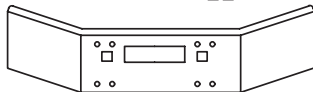

FG-0101-\_\_

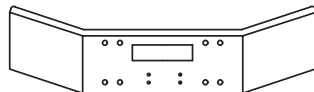

FG-0091-\_\_

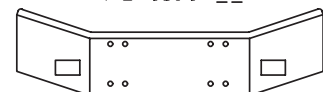

FG-2000-\_\_

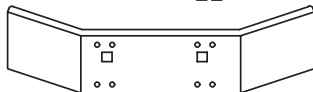

FG-0100-\_\_

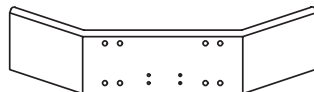

FG-0090-\_\_

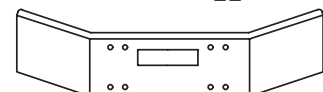

FG-0001-\_\_

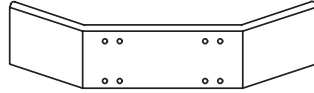

FG-0000-\_\_



### 1988-2005 T800 Widenose W/9" break-back

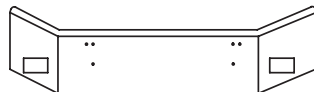
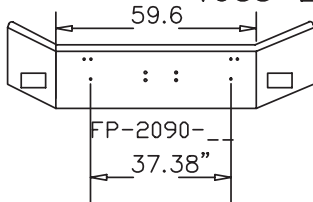

FP-2000-\_\_

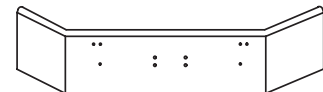

FP-0090-\_\_

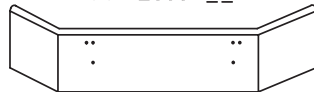

FP-0000-\_\_

**No WARRANTY on break-backs over 18"**

AVAILABLE STYLES (see page 7 for more styles)



Bumpers shown below are for MOUNTING and OPTIONS. To select a style use the two digit outside shape shown above as the last two digits of the part number

## 2004 AND NEWER T800B, T880



FN-2111-\_\_



FN-2110-\_\_

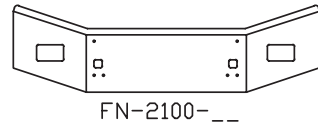

FN-2100-\_\_



FN-2010-\_\_

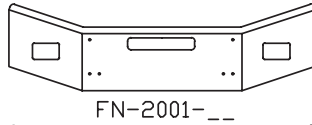

FN-2001-\_\_

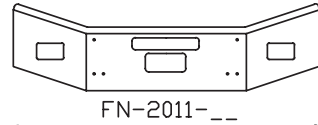

FN-2011-\_\_



FN-2101-\_\_

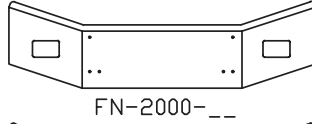

FN-2000-\_\_

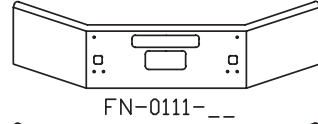

FN-0111-\_\_

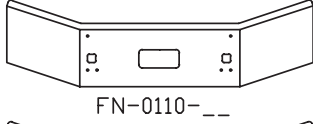

FN-0110-\_\_

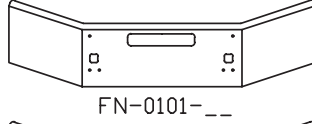

FN-0101-\_\_

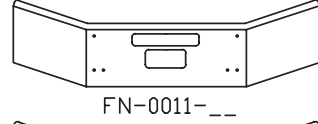

FN-0011-\_\_

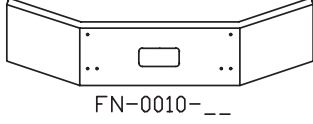

FN-0010-\_\_

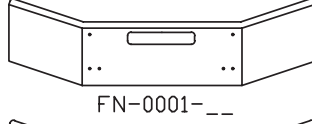

FN-0001-\_\_

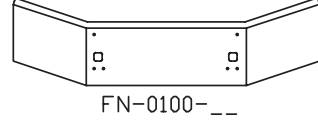

FN-0100-\_\_

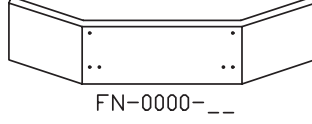

FN-0000-\_\_

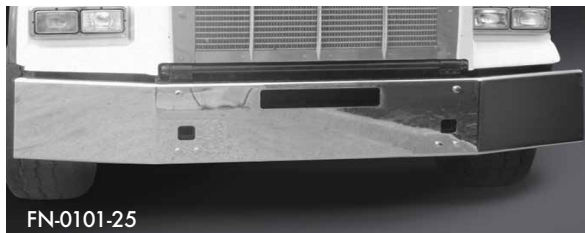

FN-0101-25



FN-0101-26

**No WARRANTY on break-backs over 18"**

## AVAILABLE STYLES (see page 7 for more styles)



Bumpers shown below are for MOUNTING and OPTIONS. To select a style use the two digit outside shape shown above as the last two digits of the part number

### 1994 - 1997 T450B W/7½" break-back (82½" long)

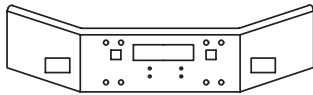

FK-2191--

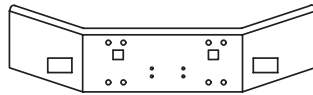

FK-2190--

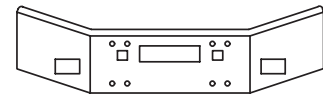

FK-2101--

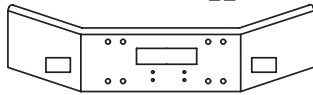

FK-2091--

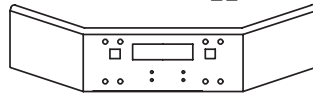

FK-0191--

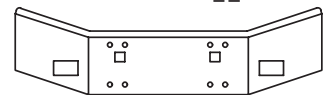

FK-2100--

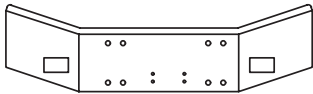

FK-2090--

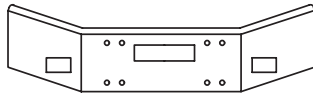

FK-2001--

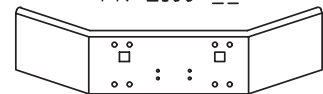

FK-0190--

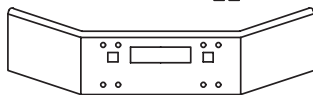

FK-0101--

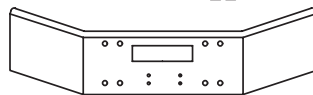

FK-0091--

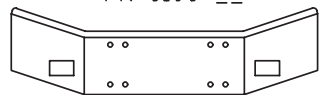

FK-2000--

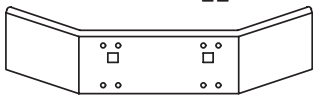

FK-0100--

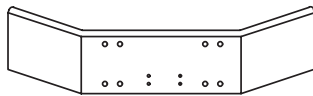

FK-0090--

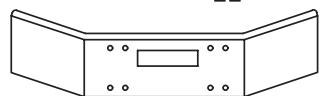

FK-0001--



FK-0000--



**No WARRANTY on break-backs over 18"**

## AVAILABLE STYLES (see page 7 for more styles)

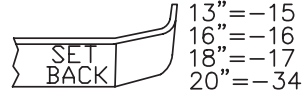

Bumpers shown below are for MOUNTING and OPTIONS. To select a style use the two digit outside shape shown above as the last two digits of the part number

### 1987-2007 T600 SET BACK AXLE (Spacers Included) (must include vent holes for warranty)

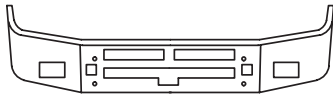

FH-2011-\_\_

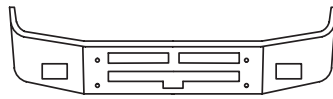

FH-2001-\_\_

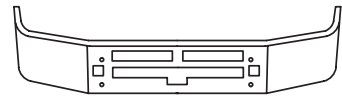

FH-0011-\_\_



FH-0011-16

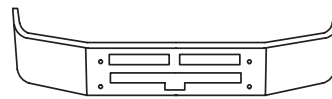

FH-0001-\_\_

### 2008-2017 T660 SET BACK AXLE (brackets included)

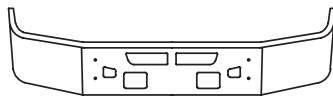

FR-2011-\_\_

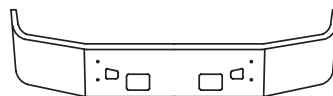

FR-2010-\_\_

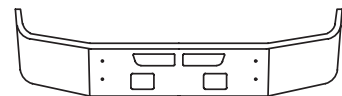

FR-2001-\_\_



FR-0011-\_\_



FR-2000-\_\_

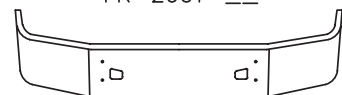

FR-0010-\_\_



FR-0001-\_\_

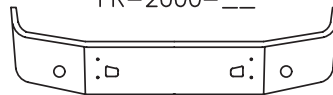

FR-5010-\_\_

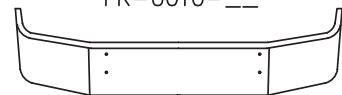

FR-0000-\_\_

#### Replacement Brackets, if needed:

13" bumper	FRO115BK
16" bumper	FRO116BK
18" bumper	FRO117BK
20" bumper	FRO134BK

#### AIR FOIL



FR-AF



FR-0011-15

**No WARRANTY on break-backs over 18"**

## AVAILABLE STYLES (see page 7 for more styles)

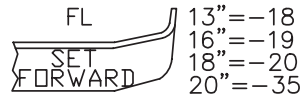
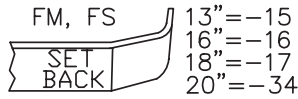

Bumpers shown below are for MOUNTING and OPTIONS. To select a style use the two digit outside shape shown above as the last two digits of the part number

### 1997-2008 T300 SET FORWARD AXLE (mounts to factory brkts)

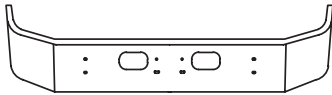

FL-0010-\_\_



END VIEW

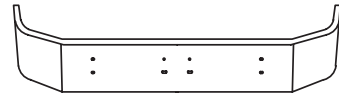

FL-0000-\_\_

### T400 SET BACK AXLE

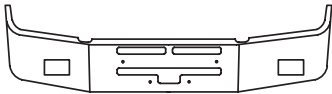

FM-2001-\_\_

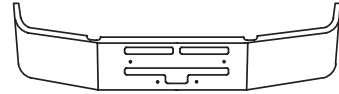

FM-0001-\_\_

### T300 2008-NEWER, T270, T370 SET BACK AXLE (brackets included) (available in 16" -16 only)

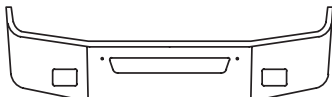

FS-2010-\_\_

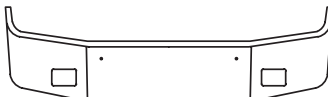

FS-2000-\_\_

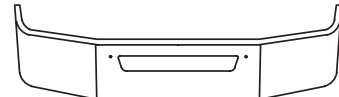

FS-0010-\_\_

Replacement Brackets, if needed:	
16" bumper	FS0116BK
18" bumper	FS0117BK
20" bumper	FS0134BK

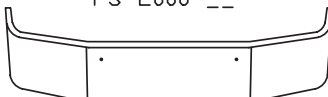

FS-0000-\_\_



FS-0010-16

### 2011 AND NEWER T440 KENWORTH SET BACK AXLE (Gullwing) (not available in stainless steel)

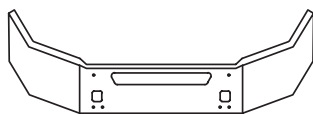

FU-0011-708

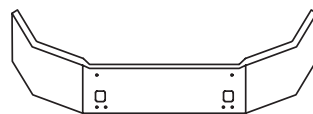

FU-0010-708

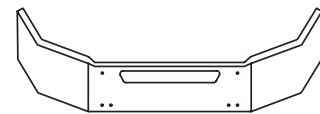

FU-0001-708

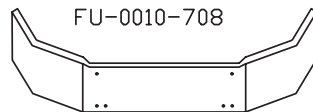

FU-0000-708

**No WARRANTY on break-backs over 18"**

## AVAILABLE STYLES (see page 7 for more styles)

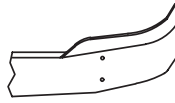

14"=-708  
 16"=-709  
 18"=-711  
 20"=-712

Bumpers shown below are for MOUNTING and OPTIONS. To select a style use the two digit outside shape shown above as the last two digits of the part number

### 2013 AND NEWER T680 SET BACK AXLE

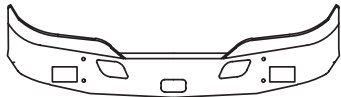

FV-2210-\_\_\_

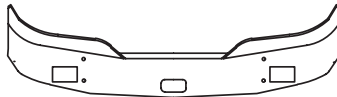

FV-2200-\_\_\_



FV-2010-\_\_\_



FV-0210-\_\_\_



FV-2000-\_\_\_

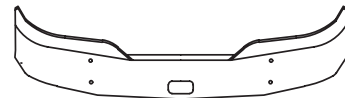

FV-0200-\_\_\_



FV-0010-\_\_\_

#### AIR FOIL



FV-AF



FV-0000-\_\_\_

Replacement Brackets, if needed:	
16" bumper	FV01708BK
18" bumper	FV01709BK
20" bumper	FV01711BK
Replacement Extensions, if needed:	
Includes hardware	FV-EXT



FV-0010-\_\_\_-V4  
 FOR WINGMAN RADAR



FV-5010-\_\_\_  
 FOR OEM FOGS





FV-0010-708

**No WARRANTY on break-backs over 18"**



## AVAILABLE STYLES (see page 7 for more styles)

 TAPERED	12"=-01	 BOXED END	12"=-09	 ROLLED END SQUARE	12"=-04
	16"=-02		16"=-10		16"=-05
	18"=-03		18"=-11		18"=-06
	20"=-31		20"=-51		20"=-41
	22"=-32		22"=-52		22"=-42

Bumpers shown below are for MOUNTING and OPTIONS. To select a style use the two digit outside shape shown above as the last two digits of the part number.

R, RL, F, FL, FS

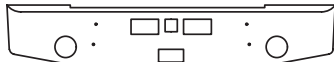

GA-1201-\_\_



GA-1200-\_\_

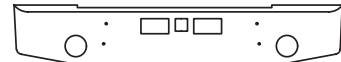

GA-1001-\_\_



GA-0201-\_\_



GA-1000-\_\_



GA-0200-\_\_



GA-0001-\_\_

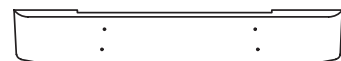

GA-0000-\_\_

## SUPERLINER CONV., CRUISELINER COE

(Not available in 12" width)

(Superliner not available in Gullwing -07)



GB-1211-\_\_



GB-1210-\_\_



GB-1201-\_\_



GB-1011-\_\_



GB-0211-\_\_



GB-1200-\_\_



GB-1010-\_\_



GB-1001-\_\_



GB-0210-\_\_



GB-0201-\_\_



GB-0011-\_\_



GB-1000-\_\_



GB-0200-\_\_

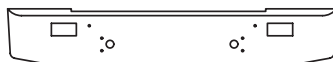

GB-0010-\_\_





GB-0001-\_\_



GB-0000-\_\_

## AVAILABLE STYLES (see page 7 for more styles)

 TAPERED	12"=-01	 BOXED END	12"=-09	 ROLLED END SQUARE	12"=-04
	16"=-02		16"=-10		16"=-05
	18"=-03		18"=-11		18"=-06
	20"=-31		20"=-51		20"=-41
	22"=-32		22"=-52		22"=-42

Bumpers shown below are for MOUNTING and OPTIONS. To select a style use the two digit outside shape shown above as the last two digits of the part number.

### R-600, R-700

(Add -GG to the end of the part # for grill guard holes)

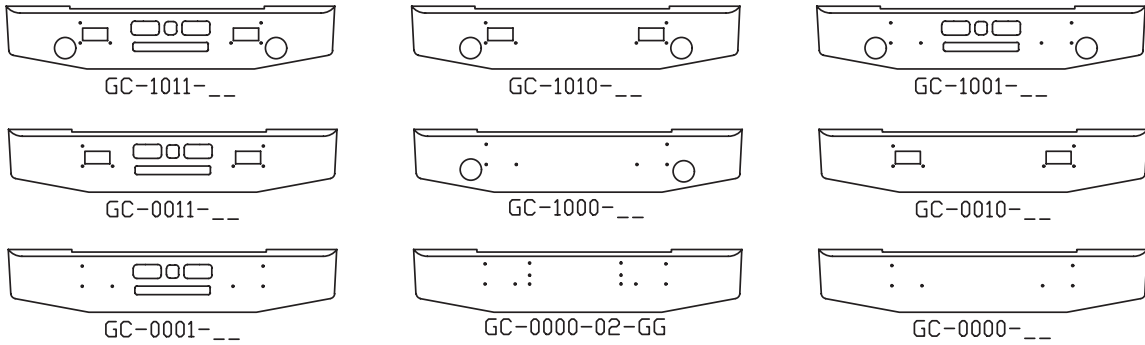

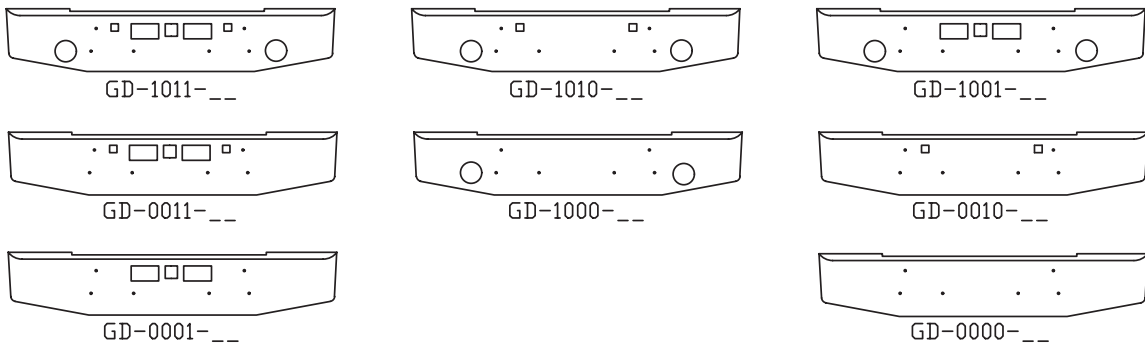

FOR GRILLE GUARDS, SEE PAGE 47

### F-600



## AVAILABLE STYLES (see page 7 for more styles)

 TAPERED	12"=-01	 BOXED END	12"=-09	 ROLLED END SQUARE	12"=-04
	16"=-02		16"=-10		16"=-05
	18"=-03		18"=-11		18"=-06
	20"=-31		20"=-51		20"=-41
	22"=-32		22"=-52		22"=-42

Bumpers shown below are for MOUNTING and OPTIONS. To select a style use the two digit outside shape shown above as the last two digits of the part number.

### VALUELINER, WESTCOAST

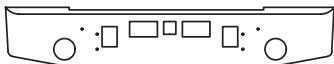

GE-1011-\_\_



GE-1010-\_\_



GE-1001-\_\_

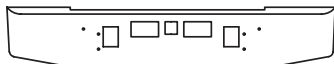

GE-0011-\_\_

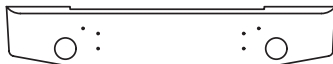

GE-1000-\_\_



GE-0010-\_\_



GE-0001-\_\_

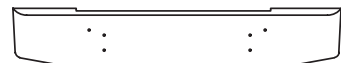

GE-0000-\_\_

### F-700, INTERSTATE



GF-1011-\_\_



GF-1010-\_\_

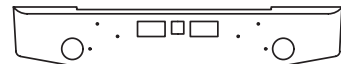

GF-1001-\_\_

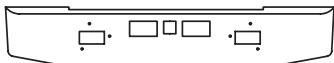

GF-0011-\_\_

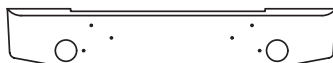

GF-1000-\_\_



GF-0010-\_\_





GF-0001-\_\_



GF-0000-\_\_

AVAILABLE STYLES (see page 7 for more styles)

 <p>TAPERED</p>	12"=-01	 <p>BOXED END</p>	12"=-09	 <p>ROLLED END SQUARE</p>	12"=-04
	16"=-02		16"=-10		16"=-05
	18"=-03		18"=-11		18"=-06
	20"=-31		20"=-51		20"=-41
	22"=-32		22"=-52		22"=-42

Bumpers shown below are for MOUNTING and OPTIONS. To select a style use the two digit outside shape shown above as the last two digits of the part number.

1986-1987 MH COE, SUPERLINER II, RW613 CONV.  
(Not available in 12" width)

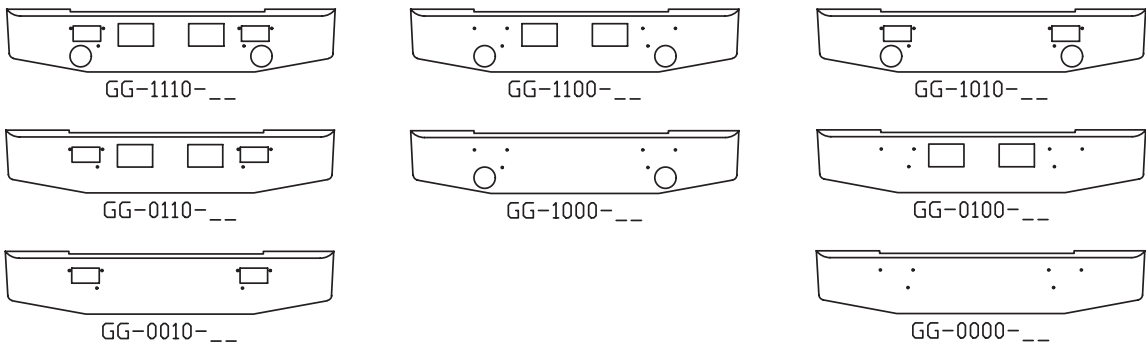

1989-2001 WESTERN CONTRACTOR CONV., RD688, RD690  
(Add -GG to the end of the part # for grill guard holes)  
(Not available in 12" width)

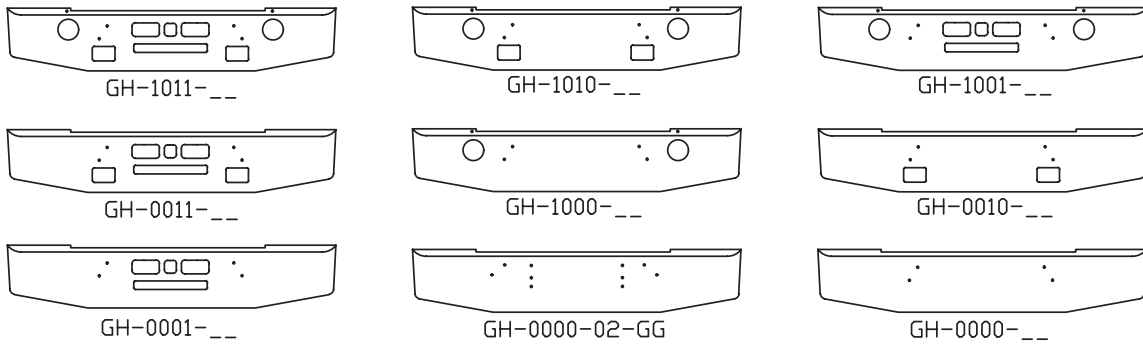

GRILLE GUARDS  
AVAILABLE IN STAINLESS STEEL ONLY

FOR PART SERIES GC, GH, GS, GV:

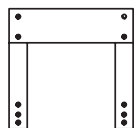

AC-GCGGS

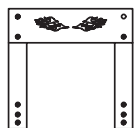

AC-GCGGS-FLAMES

FOR PART SERIES GZ:

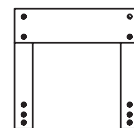

AC-GZGGS

## AVAILABLE STYLES (see page 7 for more styles)

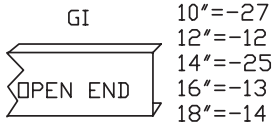

Bumpers shown below are for MOUNTING and OPTIONS. To select a style use the two digit outside shape shown above as the last two digits of the part number.

### LOGGER W/6" break-back (not available in 10"-27)

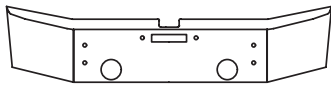

GI-1010-\_\_

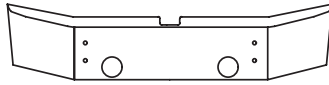

GI-1000-\_\_

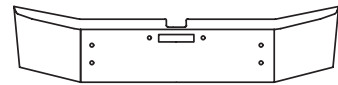

GI-0010-\_\_

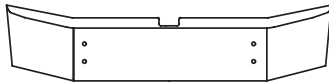

GI-0000-\_\_

### 1994-2004 CH SET FORWARD AXLE (BRACKETS BOLTED IN)



GJ-2210-\_\_



GJ-2200-\_\_

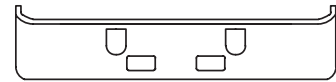

GJ-2010-\_\_



GJ-0210-\_\_

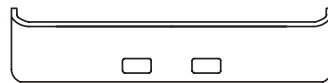

GJ-2000-\_\_



GJ-0200-\_\_

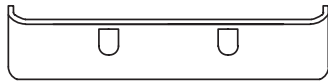

GJ-0010-\_\_



GJ-2210-18

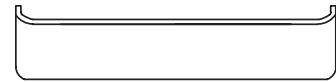

GJ-0000-\_\_

### 2005 & NEWER CHU, CHN 613 SET FORWARD (not available in 14") MOUNTS TO FACTORY BRACKETS (BRACKETS NOT INCLUDED) CUSTOMER MUST ADD THEIR OWN SPACERS FOR BUMPERS WIDER THAN 17.5"



GX-1211-\_\_

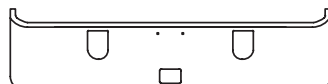

GX-0210-\_\_

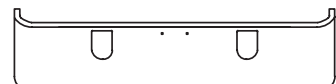

GX-0010-\_\_



GX-1000-\_\_

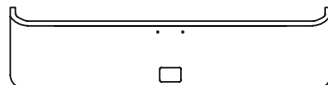

GX-0200-\_\_

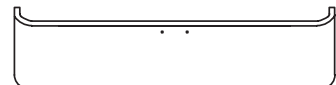

GX-0000-\_\_

Brackets, if needed:	
16" bumper	GX0119BK
18" bumper	GX0120BK
20" bumper	GX0135BK



GX-1211-19

## AVAILABLE STYLES (see page 7 for more styles)



14"=-15  
16"=-16  
18"=-17  
20"=-34



10"=-27  
12"=-12  
14"=-25  
16"=-13  
18"=-14

Bumpers shown below are for MOUNTING and OPTIONS. To select a style use the two digit outside shape shown above as the last two digits of the part number.

### 1994-2004 CH 613, SBA SET BACK AXLE (BRACKETS BOLTED IN)

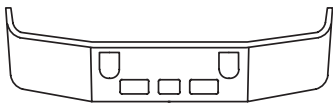

GL-2210-\_\_

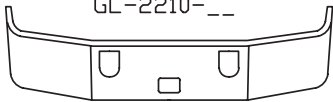

GL-0210-\_\_

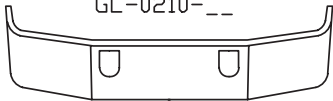

GL-0010-\_\_

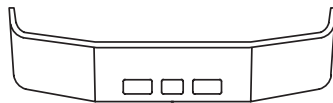

GL-2200-\_\_

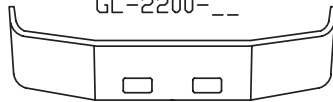

GL-2000-\_\_

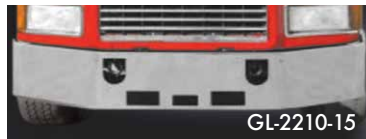

GL-2210-15

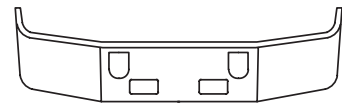

GL-2010-\_\_

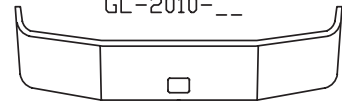

GL-0200-\_\_

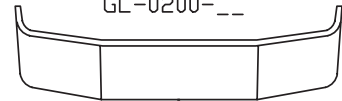

GL-0000-\_\_

**Replacement Brackets, if needed:**

14" bumper	GL0115BK
16" bumper	GL0116BK
18" bumper	GL0117BK
20" bumper	GL0134BK

### 1988-1993 CH 613 SET BACK AXLE (BRACKETS BOLTED IN)

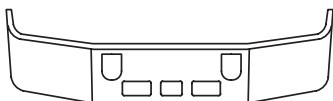

GM-2210-\_\_

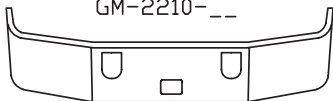

GM-0210-\_\_

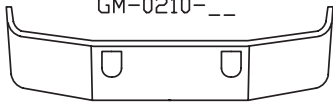

GM-0010-\_\_

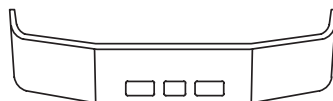

GM-2200-\_\_

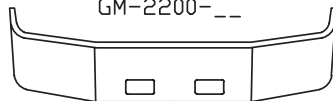

GM-2000-\_\_

**Replacement Brackets, if needed:**

14" bumper	GM0115BK
16" bumper	GM0116BK
18" bumper	GM0117BK
20" bumper	GM0134BK

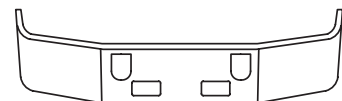

GM-2010-\_\_



GM-0200-\_\_

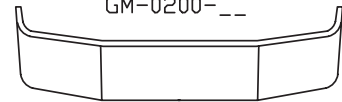

GM-0000-\_\_

SEE PAGE 47 FOR GRILLE GUARDS

**No WARRANTY on break-backs over 18"**

## AVAILABLE STYLES (see page 7 for more styles)



- 10"=-27
- 12"=-12
- 14"=-25
- 16"=-13
- 18"=-14

Bumpers shown below are for MOUNTING and OPTIONS. To select a style use the two digit outside shape shown above as the last two digits of the part number.

### 1994-2003 CL W/10 1/2" break-back

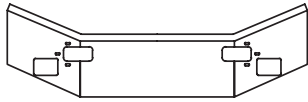

GN-2010-\_\_

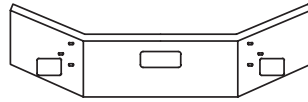

GN-2020-\_\_

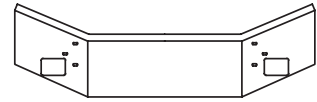

GN-2000-\_\_

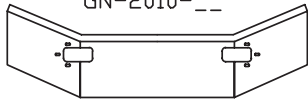

GN-0010-\_\_

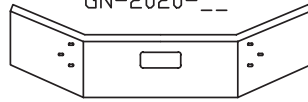

GN-0020-\_\_

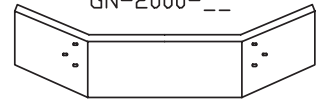

GN-0000-\_\_

### 2008-2015 MR, MRU, MD SERIES W/7" break-back

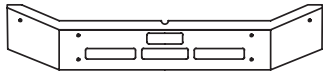

GP-0011-\_\_

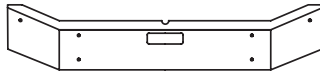

GP-0010-\_\_

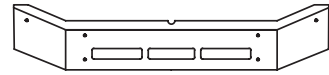

GP-0001-\_\_

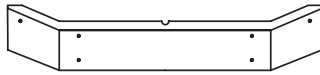

GP-0000-\_\_

### 2007 & NEWER GRANITE CTP713, GU713 W/6-1/2" break-back

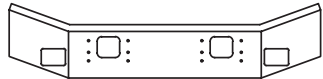

GZ-2010-\_\_



GZ-2020-\_\_

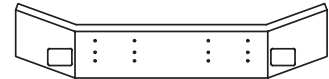

GZ-2000-\_\_

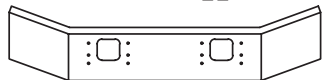

GZ-0010-\_\_



GZ-0020-\_\_

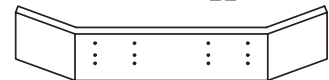

GZ-0000-\_\_



GZ-0011-\_\_

SEE PAGE 47 FOR GRILLE GUARDS

**No WARRANTY on break-backs over 18"**

## AVAILABLE STYLES (see page 7 for more styles)

GR, GT	12"=-01	GS	10"=-27	GR, GT	12"=-09	GR, GT	12"=-04
TAPERED	16"=-02	OPEN END	12"=-12	BOXED END	16"=-10	ROLLED END SQUARE	16"=-05
	18"=-03		14"=-25		18"=-11		18"=-06
	20"=-31		16"=-13		20"=-51		20"=-41
	22"=-32		18"=-14		22"=-52		22"=-42
	Bumpers shown below are for MOUNTING and OPTIONS. To select a style use the two digit outside shape shown above as the last two digits of the part number.						

### 1965 TO 1976 R600



GR-1011-\_\_



GR-1010-\_\_



GR-1001-\_\_



GR-0011-\_\_



GR-1000-\_\_



GR-0010-\_\_



GR-0001-\_\_

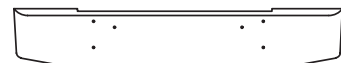

GR-0000-\_\_

### 1979 - 1988 RD SET BACK AXLE W/OPEN ENDS W/6" break-back

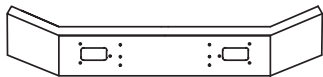

GS-0010-\_\_

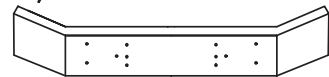

GS-0000-\_\_

SEE PAGE 47 FOR GRILLE GUARDS

### 2003 TO 2007 GRANITE, BRIDGE FORMULA



GT-2210-\_\_



GT-2200-\_\_



GT-2010-\_\_

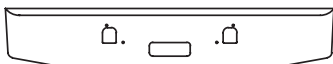

GT-0210-\_\_

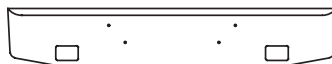

GT-2000-\_\_



GT-0200-\_\_



GT-0010-\_\_



GT-0000-\_\_

No WARRANTY on break-backs over 18"



## AVAILABLE STYLES (see page 7 for more styles)



Bumpers shown below are for MOUNTING and OPTIONS. To select a style use the two digit outside shape shown above as the last two digits of the part number.

### 2001-2004 CX613, VISION (Brackets Included, not available less than 16")

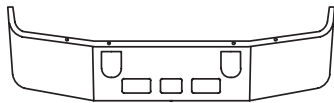

GU-2210-\_\_

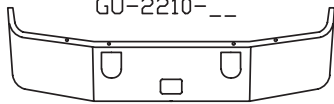

GU-0210-\_\_

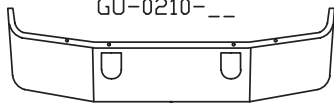

GU-0010-\_\_

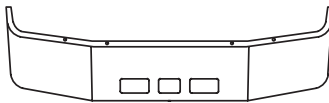

GU-2200-\_\_

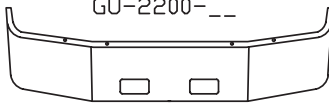

GU-2000-\_\_

Replacement Brackets, if needed:	
16" bumper	GU0116BK
18" bumper	GU0117BK
20" bumper	GU0134BK

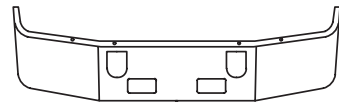

GU-2010-\_\_



GU-0200-\_\_

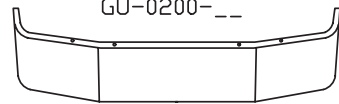

GU-0000-\_\_



### 2005 AND NEWER CXN613 2007 AND NEWER CXP613 (Brackets Included, not available less than 16")

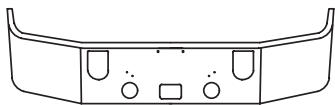

GW-1210-\_\_

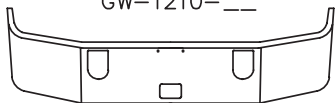

GW-0210-\_\_

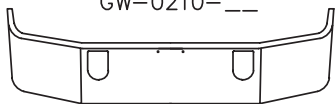

GW-0010-\_\_

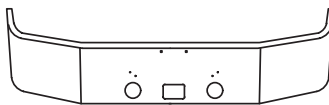

GW-1200-\_\_

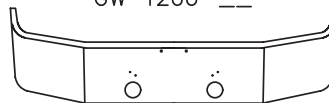

GW-1000-\_\_

#### AIR FOIL



GW-AF

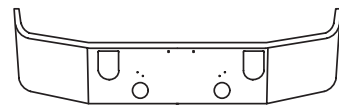

GW-1010-\_\_

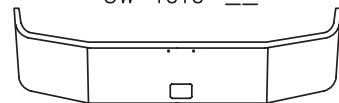

GW-0200-\_\_

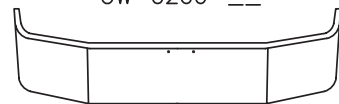

GW-0000-\_\_

Replacement Brackets, if needed:	
16" bumper	GW0116BK
18" bumper	GW0117BK
20" bumper	GW0134BK

**No WARRANTY on break-backs over 18"**

## AVAILABLE STYLES (see page 7 for more styles)

GV, GQ

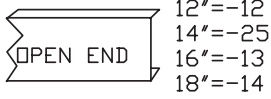

GY

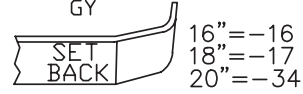

Bumpers shown below are for MOUNTING and OPTIONS. To select a style use the two digit outside shape shown above as the last two digits of the part number.

### CV SERIES

RD688DM W/6" break-back (check next category)



GV-0010-\_\_

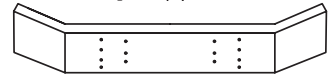

GV-0000-\_\_

RD688, RD690 W/6" break-back (check prior category)

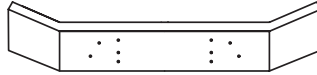

GQ-0000-\_\_

### 2008 AND NEWER CXU SERIES SET BACK AXLE, 2018 AND NEWER ANTHEM (CLAD REPLACEMENT)

Replaces stainless clad bumpers, mounts to existing clad brackets

For CXU plastic bumper replacement, also order brackets from chart below

Will not replace Anthem plastic bumpers

Not available in widths less than 16"



GY-1211-\_\_



GY-1200-\_\_

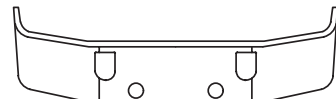

GY-1010-\_\_



GY-0211-\_\_



GY-0210-\_\_

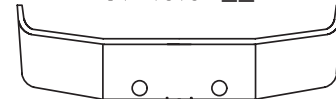

GY-1000-\_\_

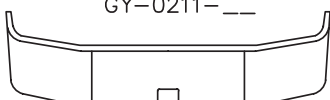

GY-0200-\_\_

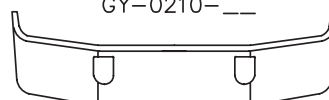

GY-0010-\_\_

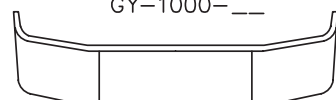

GY-0000-\_\_

### AIR FOIL



GY-AF

Replacement Brackets, if needed:	
16" bumper	GY0116BK
18" bumper	GY0117BK
20" bumper	GY0134BK



**No WARRANTY on break-backs over 18"**

## AVAILABLE STYLES (see page 7 for more styles)



12"=-01  
16"=-02  
18"=-03  
20"=-31  
22"=-32



12"=-09  
16"=-10  
18"=-11  
20"=-51  
22"=-52



12"=-04  
16"=-05  
18"=-06  
20"=-41  
22"=-42

Bumpers shown below are for MOUNTING and OPTIONS. To select a style use the two digit outside shape shown above as the last two digits of the part number.

### 1967-1986 CONV. 359, 1967-1980 COE 352

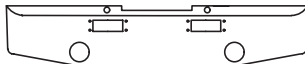

HA-1010-\_\_

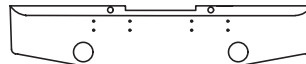

HA-1000-\_\_

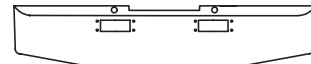

HA-0010-\_\_

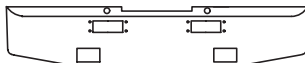

HA-2010-\_\_

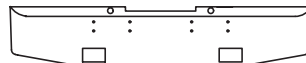

HA-2000-\_\_

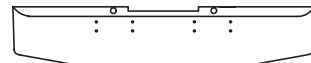

HA-0000-\_\_

### 1987-2006 CONV. 378, 379, 357 SFA

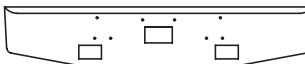

HC-2010-\_\_



HC-2000-\_\_



HC-0010-\_\_

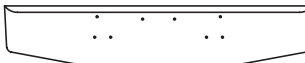

HC-0020-\_\_



HC-0010-06

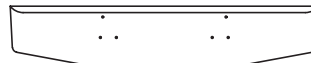

HC-0000-\_\_

### 2007 AND NEWER CONV. 365, 367, 388, 389, 567

ALSO FITS KENWORTH W990. SEE PAGE 37

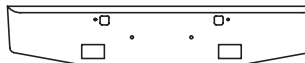

HV-2010-\_\_

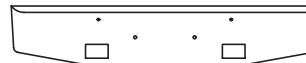

HV-2000-\_\_

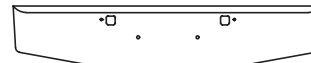

HV-0010-\_\_

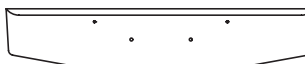

HV-0000-\_\_



HV-0010-06



HV-0090-\_\_

### 2010-NEWER CONV. 388 high ground clearance(Shown 12" width)

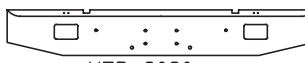

HOB-2090-\_\_

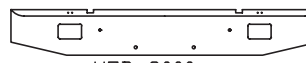

HOB-2000-\_\_

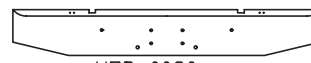

HOB-0090-\_\_

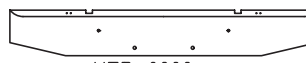

HOB-0000-\_\_



**VP120004**  
PB TOW PIN COVER - 378, 379 -  
1987 & NEWER  
FITS HC SERIES



**VK120003**  
TOW PIN COVER - MOUNTS W/ HARDWARE - PAIR  
FITS HV SERIES

**BUMPER SUPPORT BRACKETS  
PETERBILT MODEL 389**

Add these brackets for a more rigid installation.  
Powder-coated steel.  
Fasteners not included.

**VCN11-6061-20** fits 16" to 20" bumpers  
**VCN11-6061-22** fits 20" to 22" bumpers



VCN11-6061-20 shown on 20" bumper  
(fasteners not shown, not included)

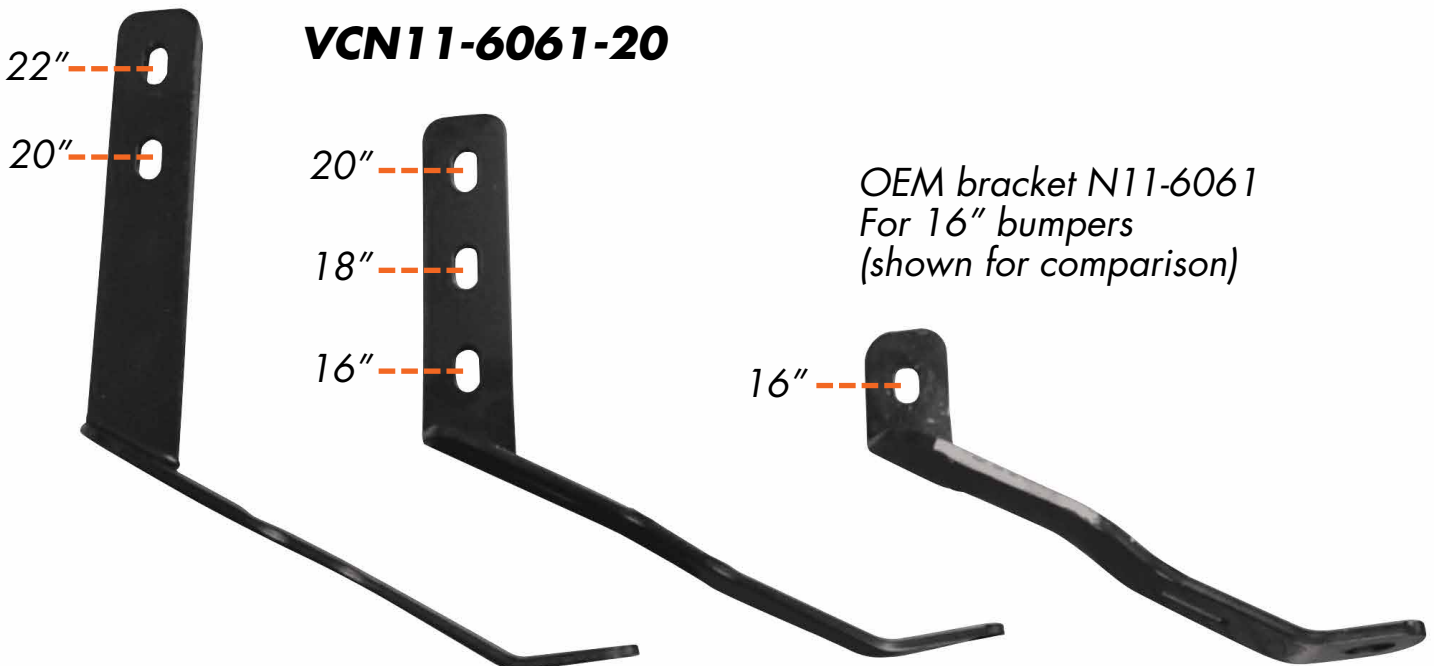

**VCN11-6061-22**



**VCN11-6061-20**

OEM bracket N11-6061  
For 16" bumpers  
(shown for comparison)

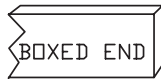
AVAILABLE STYLES (see page 7 for more styles)

 <p>TAPERED</p>	12"=-01	 <p>BOXED END</p>	12"=-09	 <p>ROLLED END SQUARE</p>	12"=-04
	16"=-02		16"=-10		16"=-05
	18"=-03		18"=-11		18"=-06
	20"=-31		20"=-51		20"=-41
	22"=-32		22"=-52		22"=-42

Bumpers shown below are for MOUNTING and OPTIONS. To select a style use the two digit outside shape shown above as the last two digits of the part number.

1987 TO 1994 CONV. 375 W/2" break-back  
(check HI pattern before ordering)

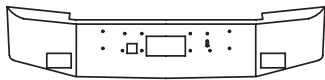

HD-2011-\_\_

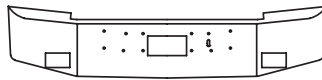

HD-2010-\_\_

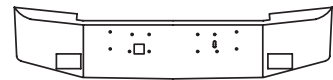

HD-2001-\_\_

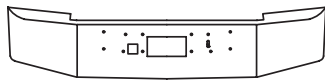

HD-0011-\_\_

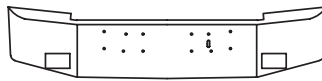

HD-2000-\_\_

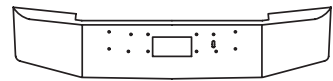

HD-0010-\_\_

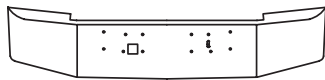

HD-0001-\_\_

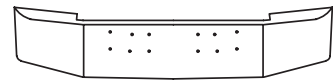

HD-0000-\_\_

1973 TO 1986 LOGGER

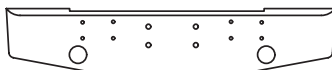

HE-1090-\_\_



HE-1000-\_\_

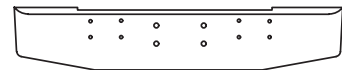

HE-0090-\_\_



HE-0000-\_\_

1987 TO 2007 LOGGER

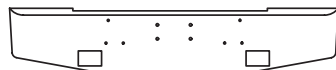

HF-2090-\_\_

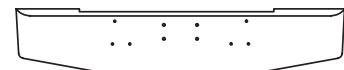

HF-0090-\_\_

## AVAILABLE STYLES (see page 7 for more styles)



Bumpers shown below are for MOUNTING and OPTIONS. To select a style use the two digit outside shape shown above as the last two digits of the part number.

### 1987 TO 2004

357 LOGGER W/19" break-back w/open ends  
378 SET BACK AXLE (diamond plate available on request)

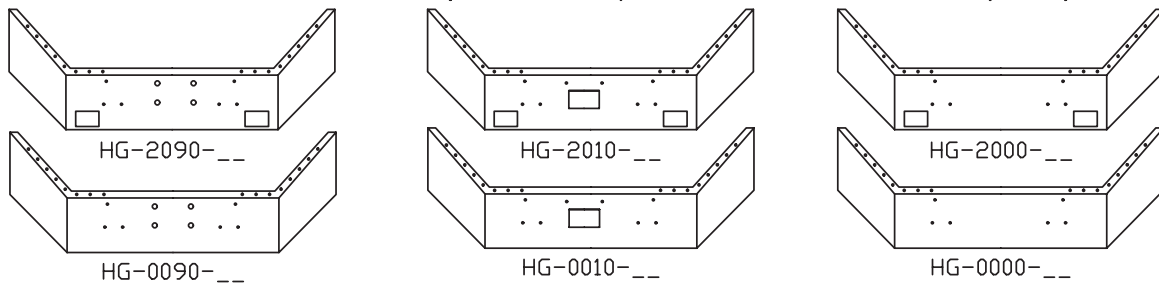

### TOP PLATES FOR HG BUMPER (specify Valley or Factory)

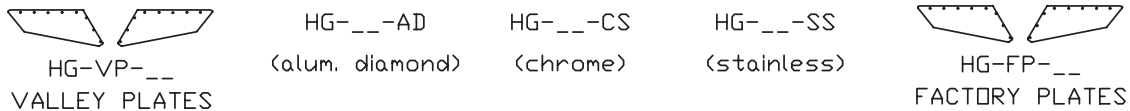

1987-1997 CONV. 377, PRIOR TO 1991 377AE SET BACK AXLE, 119BBC  
(brackets included, check HN pattern before ordering)

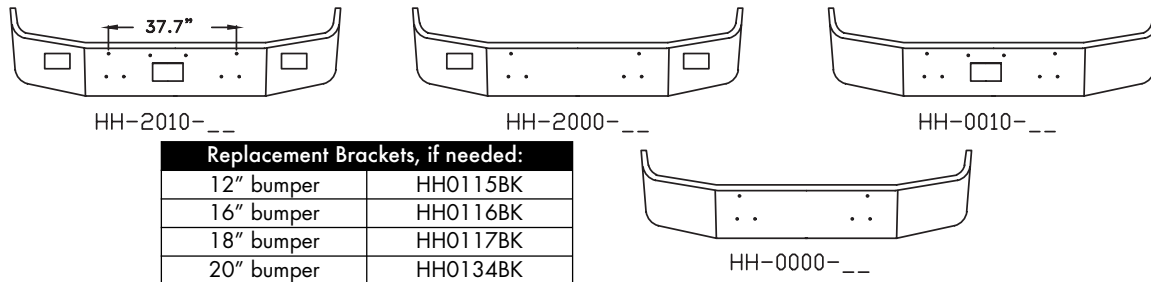

1997 TO 2007 MODEL 377 SET BACK AXLE 120BBC/122BBC  
MODEL 385 SET BACK AXLE 120BBC  
BRACKETS INCLUDED (CHECK HH PATTERN BEFORE ORDERING)

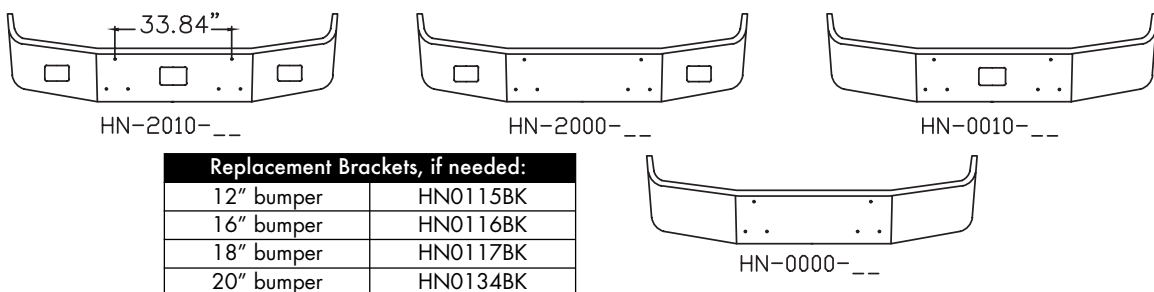

**No WARRANTY on break-backs over 18"**

AVAILABLE STYLES (see page 7 for more styles)

HK TAPERED	16"=-02 18"=-03 20"=-31 22"=-32	HI, HJ SET FORWARD	13"=-18 16"=-19 18"=-20 20"=-35	HK BOXED END	16"=-10 18"=-11 20"=-51 22"=-52	HK ROLLED END SQUARE	16"=-05 18"=-06 20"=-41 22"=-42
---------------	--	-----------------------	--	-----------------	--	----------------------------	--

Bumpers shown below are for MOUNTING and OPTIONS. To select a style use the two digit outside shape shown above as the last two digits of the part number.

1987 TO 1991 CONV. 377 SET FORWARD

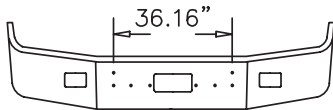

HI-2010-\_\_

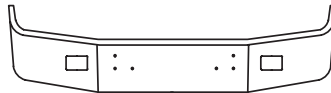

HI-2000-\_\_



HI-0010-\_\_

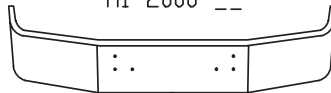

HI-0000-\_\_

1987 AND NEWER CONV. 377AE, 375 SET FORWARD AXLE

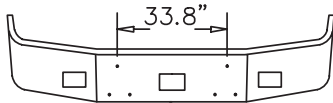

HJ-2010-\_\_

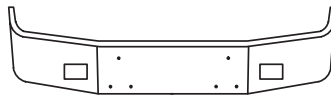

HJ-2000-\_\_



HJ-0010-\_\_

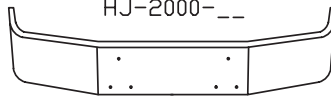

HJ-0000-\_\_

1981 AND NEWER 362 COE  
(Not available in 12" width)



HK-1110-\_\_

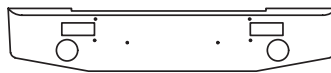

HK-1100-\_\_



HK-1010-\_\_



HK-0110-\_\_

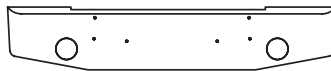

HK-1000-\_\_

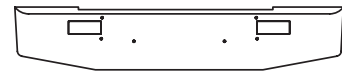

HK-0100-\_\_

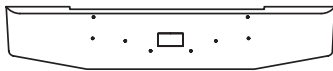

HK-0010-\_\_

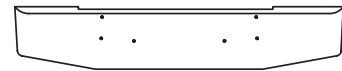

HK-0000-\_\_

No WARRANTY on break-backs over 18"

## AVAILABLE STYLES (see page 7 for more styles)

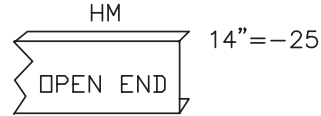
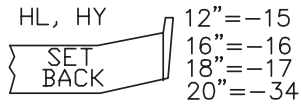

Bumpers shown below are for MOUNTING and OPTIONS. To select a style use the two digit outside shape shown above as the last two digits of the part number.

### 1995 TO 2007 385 CONVENTIONAL SET BACK AXLE 112" BBC

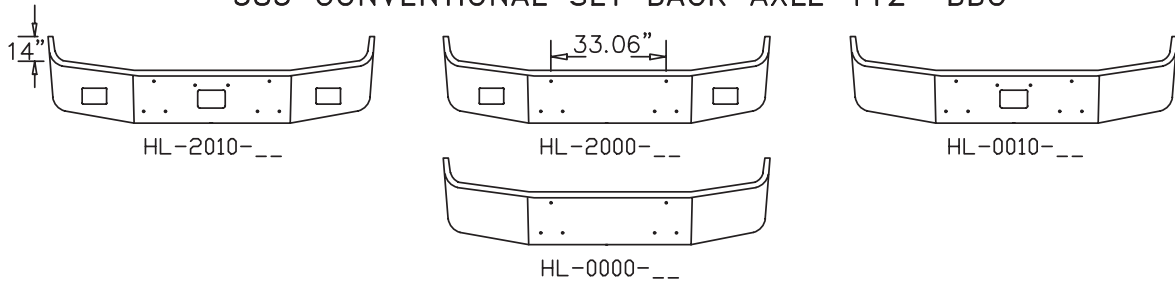

### 1995 TO 2007 385 CONVENTIONAL SET BACK AXLE 120" BBC

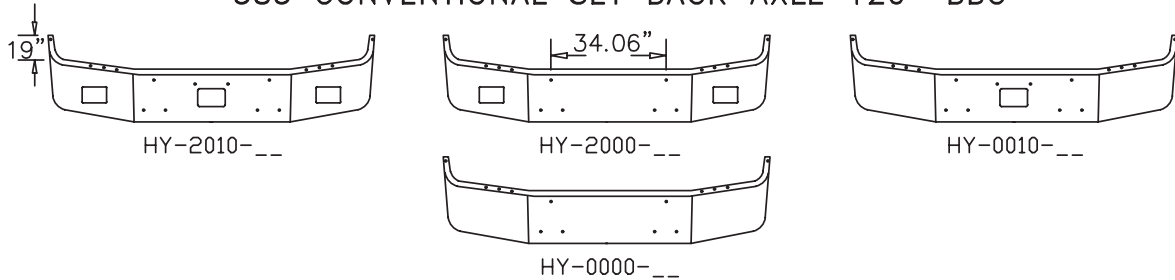

### 1990 AND NEWER 320 COE (available in 14"-25 only)

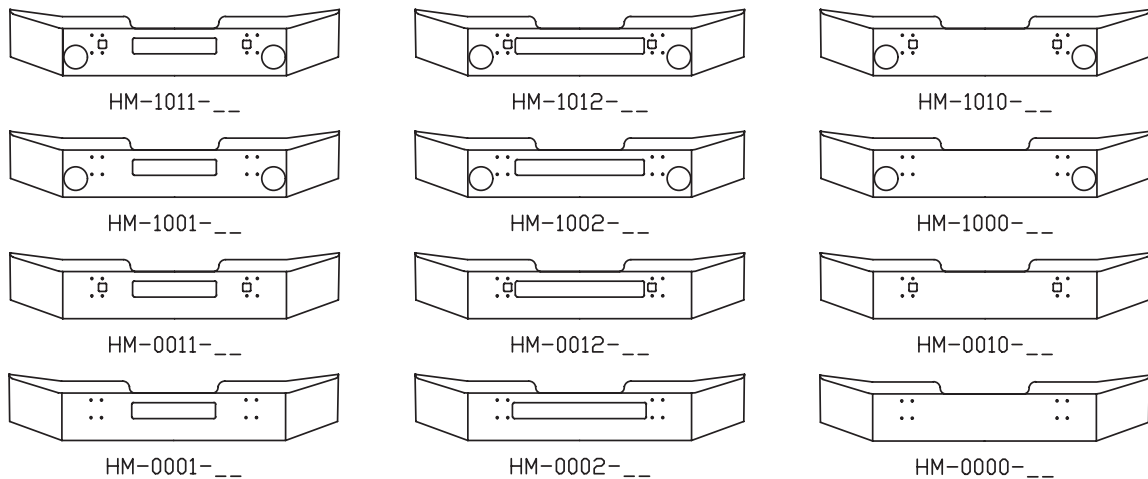

**No WARRANTY on break-backs over 18"**



**AVAILABLE STYLES (see page 7 for more styles)**

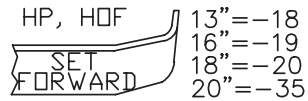
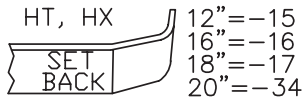

Bumpers shown below are for MOUNTING and OPTIONS. To select a style use the two digit outside shape shown above as the last two digits of the part number.

**1997 – 2005 330 SET FORWARD AXLE (90° Top flange only)  
WITH 12K/14K RATED FRONT AXLE**

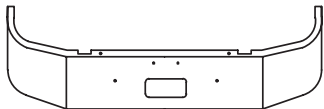

HP-0010-\_\_

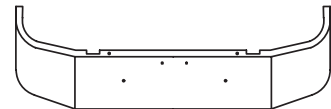

HP-0000-\_\_

**2006 – 2014 MODELS 330, 335, 340, 348  
WITH 12K/14K RATED FRONT AXLE (BRACKETS INCLUDED)**

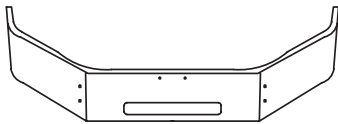

HT-0010-\_\_

Replacement Brackets, if needed:	
12" bumper	HTO115BK
16" bumper	HTO116BK
18" bumper	HTO117BK
20" bumper	HTO134BK

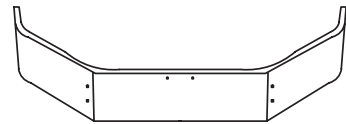

HT-0000-\_\_

**2006 – 2014 MODELS 330, 335, 340, 348  
WITH 16K RATED FRONT AXLE (BRACKETS NOT INCLUDED)**

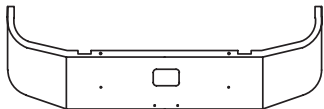

HDF-0010-\_\_

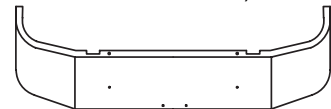

HDF-0000-\_\_

**2007 AND NEWER 367, 567 SET BACK AXLE (brkts not included)**

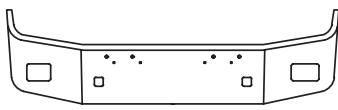

HX-2010-\_\_

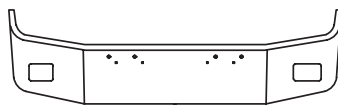

HX-2000-\_\_



HX-0010-\_\_

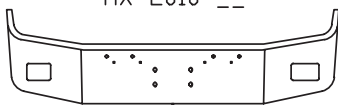

HX-2090-\_\_

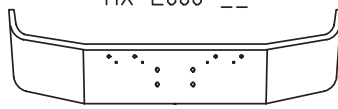

HX-0090-\_\_

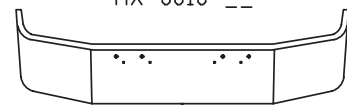

HX-0000-\_\_

**TOP PLATES FOR HX BUMPER (fits Valley & Factory bumper)**



HX-VP-\_\_

HX-VP-AD  
(alum. diamond)

HX-VP-CS  
(chrome)

HX-VP-SS  
(stainless)

**No WARRANTY on break-backs over 18"**

## AVAILABLE STYLES (see page 7 for more styles)

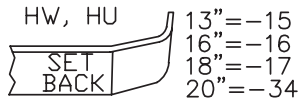

Bumpers shown below are for MOUNTING and OPTIONS. To select a style use the two digit outside shape shown above as the last two digits of the part number.

### 362E SET FORWARD AXLE



HQ-2210-\_\_



HQ-2200-\_\_

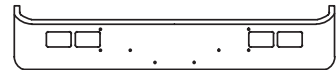

HQ-2010-\_\_

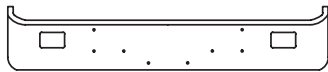

HQ-2000-\_\_

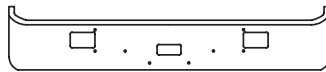

HQ-0210-\_\_

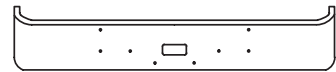

HQ-0200-\_\_

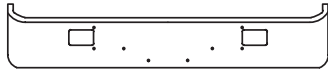

HQ-0010-\_\_

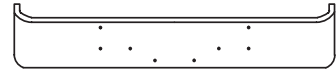

HQ-0000-\_\_

### 2008 AND NEWER 384 & 386 SET BACK AXLE REPLACES CLAD BUMPERS, NO BRACKETS INCLUDED MOUNTS TO FACTORY CLAD BRACKETS

FOR 384 PLASTIC BUMPER REPLACEMENT ADD BRACKETS FROM CHART BELOW



HW-2011-\_\_



HW-2010-\_\_



HW-2001-\_\_



HW-0011-\_\_

Replacement Brackets, if needed:	
13" bumper	HW0115BK
16" bumper	HW0116BK
18" bumper	HW0117BK
20" bumper	HW0134BK

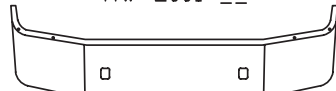

HW-0010-\_\_



HW-0001-\_\_

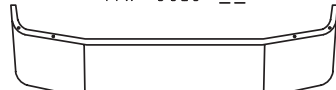

HW-0000-\_\_



HW-0011-15

### 2006 & NEWER 386 SET BACK AXLE (brackets included) (standard width 16" Not available in less than 16" width) PLASTIC BUMPER REPLACEMENT. SEE HW SERIES ABOVE FOR CLAD REPLACEMENT.

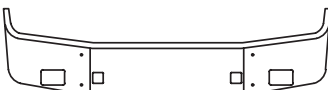

HU-2010-\_\_



HU-0010-16

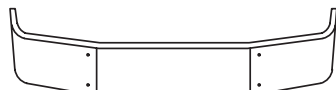

HU-0000-\_\_

**No WARRANTY on break-backs over 18"**

AVAILABLE STYLES (see page 7 for more styles)

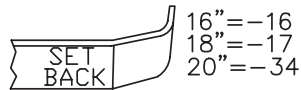

Bumpers shown below are for MOUNTING and OPTIONS. To select a style use the two digit outside shape shown above as the last two digits of the part number.

1999-2001 387 SET BACK AXLE (brackets included)

(standard width 16" Not available in less than 16" width)

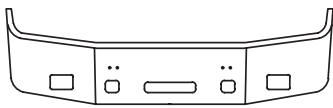

HR-2210-\_\_

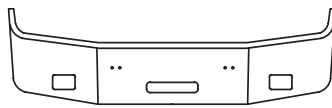

HR-2200-\_\_

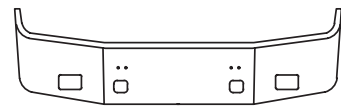

HR-2010-\_\_

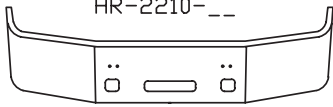

HR-0210-\_\_

Replacement Brackets, if needed:	
16" bumper	HR0116BK
18" bumper	HR0117BK
20" bumper	HR0134BK



HR-0200-\_\_

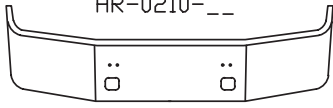

HR-0010-\_\_



HR-0210-16

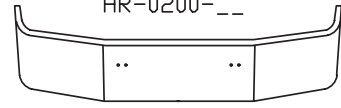

HR-0000-\_\_

2002-2011 387 SET BACK AXLE (brackets included)

(standard width 16" Not available in less than 16" width)

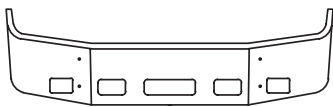

HS-2210-\_\_

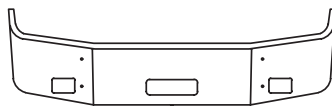

HS-2200-\_\_

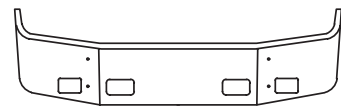

HS-2010-\_\_

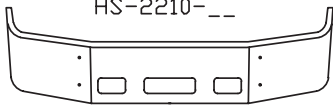

HS-0210-\_\_

Replacement Brackets, if needed:	
16" bumper	HS0116BK
18" bumper	HS0117BK
20" bumper	HS0134BK



HS-0200-\_\_

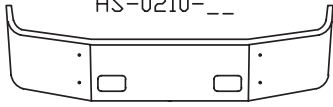

HS-0010-\_\_



HS-2210-16

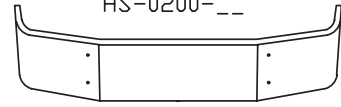

HS-0000-\_\_

**No WARRANTY on break-backs over 18"**

## AVAILABLE STYLES (see page 7 for more styles)

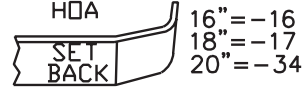

Bumpers shown below are for MOUNTING and OPTIONS. To select a style use the two digit outside shape shown above as the last two digits of the part number.

### 2012 & NEWER 579 SET BACK AXLE (Chrome Replacement)

Available with square or factory round lights (brackets included)

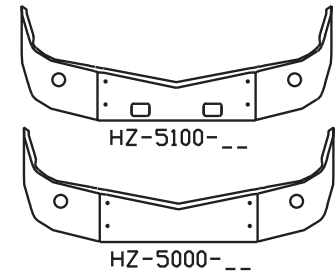
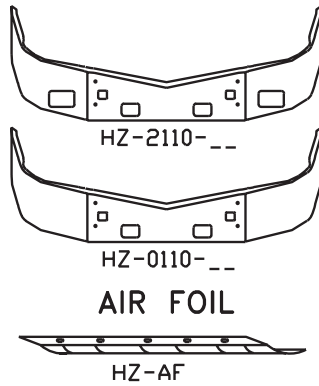
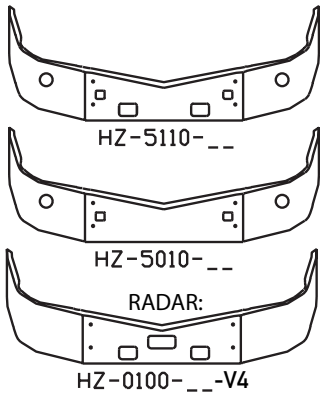

Replacement Brackets, if needed:	
16" bumper	HZ0116BK
18" bumper	HZ0117BK
20" bumper	HZ0134BK
Replacement Extensions, if needed:	
Includes hardware	HZ-EXT

### 2012 & NEWER 587 SET BACK AXLE (Chrome Replacement)

Available with square or factory round lights (brackets included)

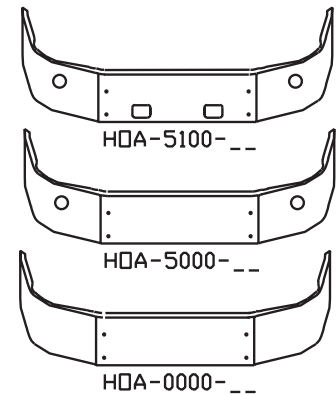
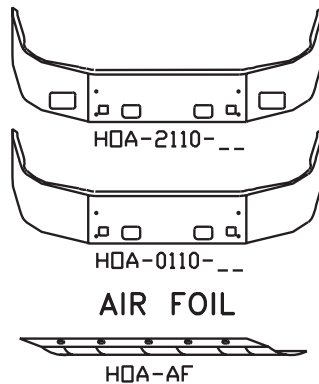
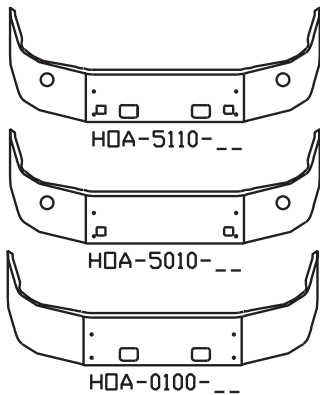

Replacement Brackets, if needed:	
16" bumper	HOA0116BK
18" bumper	HOA0117BK
20" bumper	HOA0134BK



**No WARRANTY on break-backs over 18"**

## AVAILABLE STYLES (see page 7 for more styles)

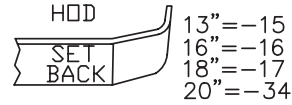
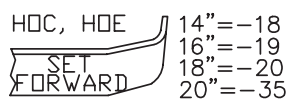

Bumpers shown below are for MOUNTING and OPTIONS. To select a style use the two digit outside shape shown above as the last two digits of the part number.

### 2015 AND NEWER 337 SET FORWARD AXLE (brkts included)

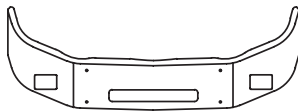

HOC-2010--



HOC-2000--

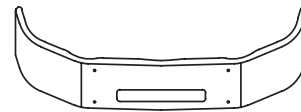

HOC-0010--



HOC-0010-18

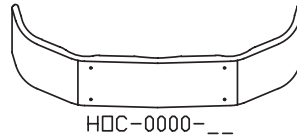

HOC-0000--

Replacement Brackets, if needed:	
16" bumper	HOC0119BK
18" bumper	HOC0120BK
20" bumper	HOC0135BK

### 2005 TO 2007 357, 378 SET BACK AXLE (Chrome Replacement)

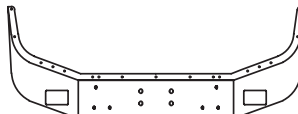

HOD-2090--

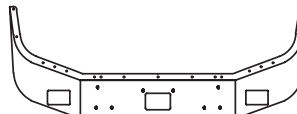

HOD-2010--

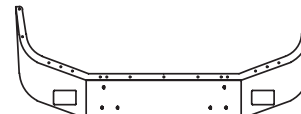

HOD-2000--

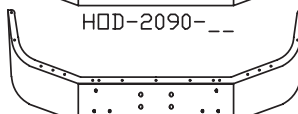

HOD-0090--



HOD-0010--

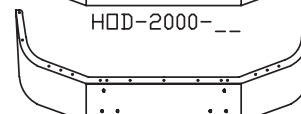

HOD-0000--

### TOP PLATES FOR HOD



HOD-VP--

HOD-VP-AD  
(alum. diamond)

HOD-VP-CS  
(chrome)

HOD-VP-SS  
(stainless)

### 2012 AND NEWER MODEL 337 2010 AND NEWER 348 SET FORWARD AXLE

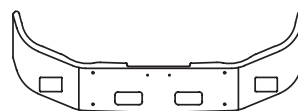

HOE-2010--



WITHOUT FEPTO

HOE-2000--

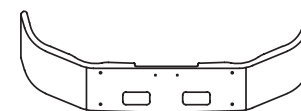

HOE-0010--



HOE-0010-18

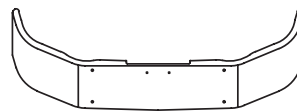

HOE-0000--

Replacement Brackets, if needed:	
16" bumper	HOE0119BK
18" bumper	HOE0120BK
20" bumper	HOE0135BK

**No WARRANTY on break-backs over 18"**

## AVAILABLE STYLES (see page 7 for more styles)

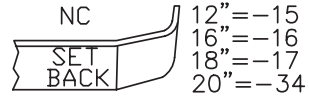
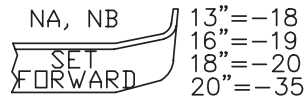

Bumpers shown below are for MOUNTING and OPTIONS. To select a style use the two digit outside shape shown above as the last two digits of the part number.

### 2000 - 2009 LT7501 SET FORWARD AXLE INCLUDES 3/4" SPACERS FOR MOUNTING

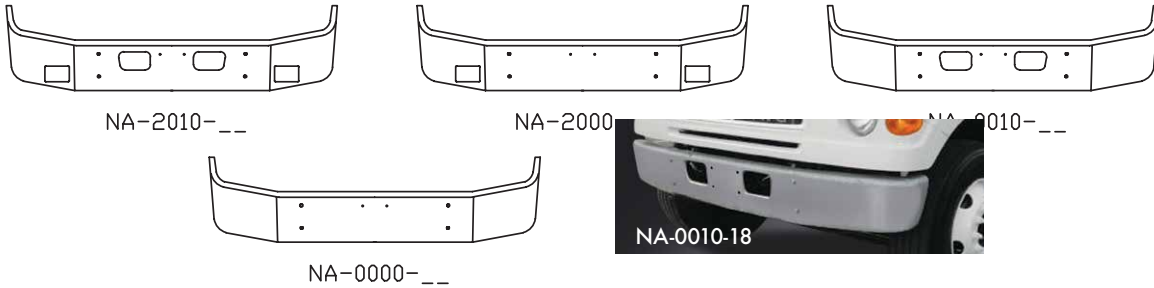

### 2000 TO 2006 ACTERRA SET FORWARD AXLE

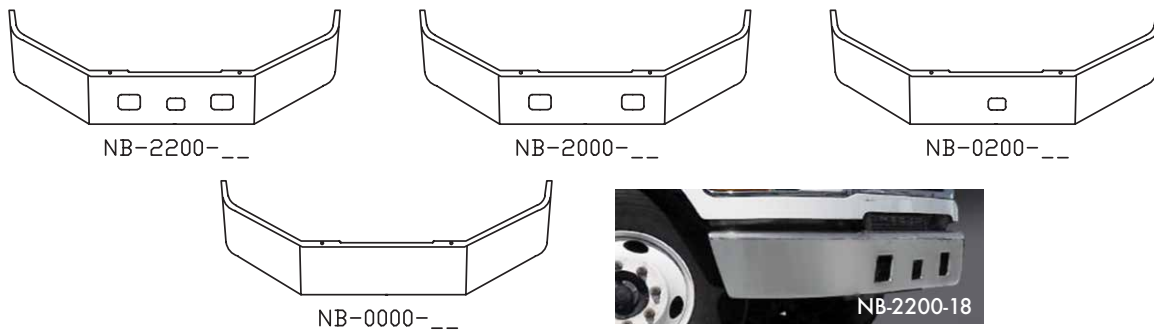

### 1996 - 2009 STERLING LT9513, LT9500 SET BACK AXLE AND FORD L-SERIES (brackets included)



Replacement Brackets, if needed:	
12" bumper	NC0115BK
16" bumper	NC0116BK
18" bumper	NC0117BK
20" bumper	NC0134BK

**No WARRANTY on break-backs over 18"**

AVAILABLE STYLES (see page 7 for more styles)



Bumpers shown below are for MOUNTING and OPTIONS. To select a style use the two digit outside shape shown above as the last two digits of the part number.

1996 TO 2009  
STERLING AT9500 SET BACK AXLE  
3PC. BUMPER (Fits factory air dam)

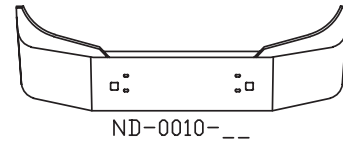
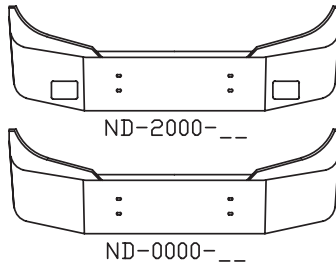
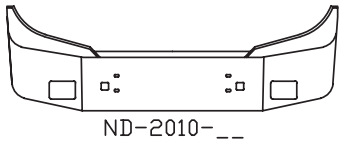

No WARRANTY on break-backs over 18"

## AVAILABLE STYLES (see page 7 for more styles)

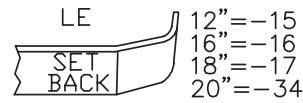
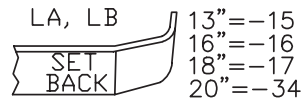

Bumpers shown below are for MOUNTING and OPTIONS. To select a style use the two digit outside shape shown above as the last two digits of the part number.

### 1988-1997 WA, WIA MODEL SET BACK AXLE (brackets included)

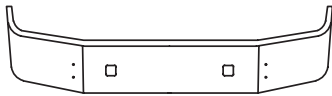

LA-0010-\_\_

Replacement Brackets, if needed:	
13" bumper	LA0115BK
16" bumper	LA0116BK
18" bumper	LA0117BK
20" bumper	LA0134BK

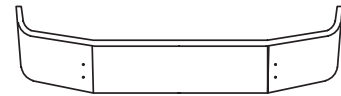

LA-0000-\_\_

### 1996-2003 VNL610, VNL660, VNL770, SET BACK AXLE (brkts included) (replaces plastic bumper, check next category)

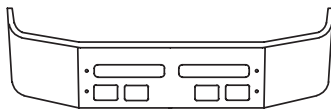

LB-4010-\_\_

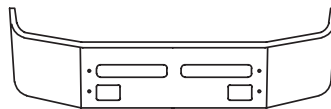

LB-2010-\_\_

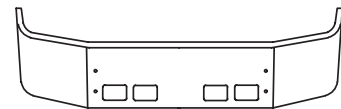

LB-4000-\_\_



LB-0010-16

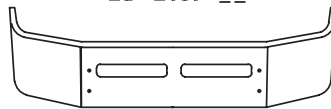

LB-0010-\_\_

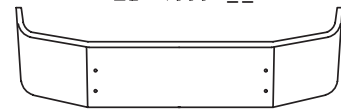

LB-0000-\_\_

### 1996-2003 VNL42T, VNL64T SET BACK AXLE (brackets included) (replaces clad bumper, check prior category)



LE-2011-\_\_

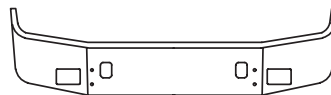

LE-2010-\_\_



LE-2001-\_\_

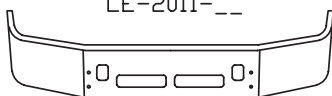

LE-0011-\_\_

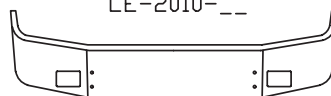

LE-2000-\_\_

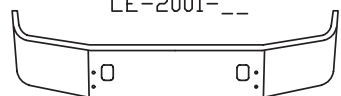

LE-0010-\_\_

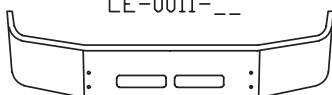

LE-0001-\_\_



LE-2011-15

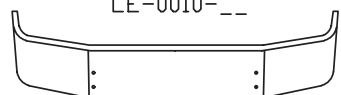

LE-0000-\_\_

Replacement Brackets, if needed:	
13" bumper	LE0115BK
16" bumper	LE0116BK
18" bumper	LE0117BK
20" bumper	LE0134BK

**No WARRANTY on break-backs over 18"**



## AVAILABLE STYLES (see page 7 for more styles)

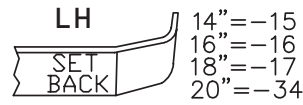
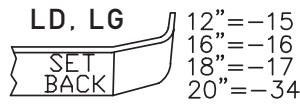

Bumpers shown below are for MOUNTING and OPTIONS. To select a style use the two digit outside shape shown above as the last two digits of the part number.

### 1998-2003 VNM42T, VNM64T SET BACK AXLE (brackets included)



LD-0011-\_\_



LD-0011-15

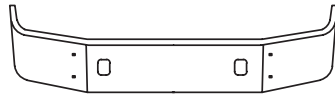

LD-0010-\_\_

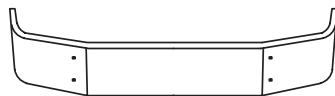

LD-0000-\_\_

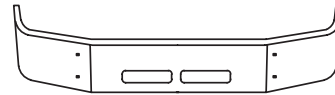

LD-0001-\_\_

Replacement Brackets, if needed:	
13" bumper	LD0115BK
16" bumper	LD0116BK
18" bumper	LD0117BK
20" bumper	LD0134BK

### 2004-2017 VNM SET BACK AXLE (direct mount) (must be -16 for fog light option)

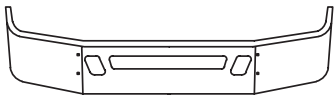

LG-0011-\_\_



LG-0011-15

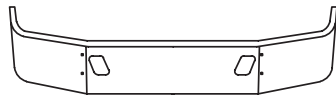

LG-0010-\_\_

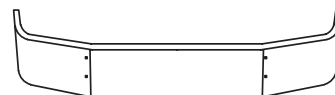

LG-0000-\_\_

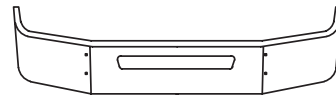

LG-0001-\_\_

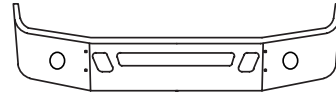

LG-5011-  
FOR OEM FOGS

### 2004-2017 VNL64T 630, 670, 780 SET BACK AXLE (brkts included)

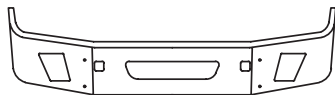

LH-5011-\_\_

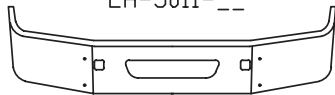

LH-0011-\_\_

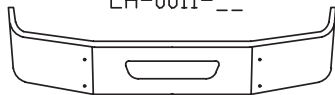

LH-0001-\_\_

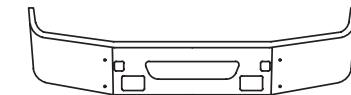

LH-2011-\_\_



LH-5011-15

#### AIR FOIL



LH-AF

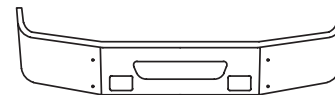

LH-2001-\_\_

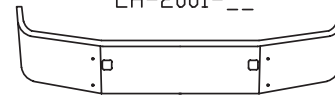

LH-0010-\_\_

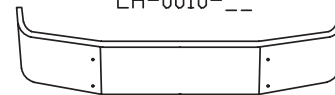



LH-0000-\_\_

Replacement Brackets, if needed:	
13" bumper	LH0115BK
16" bumper	LH0116BK
18" bumper	LH0117BK
20" bumper	LH0134BK

**No WARRANTY on break-backs over 18"**

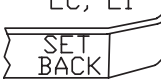
## AVAILABLE STYLES (see page 7 for more styles)

<p>LF</p>  <p>16"=-02 18"=-03 20"=-31 22"=-32</p>	<p>LC, LI</p>  <p>13"=-15 16"=-16 18"=-17 20"=-34</p>	<table border="0"> <tr> <td>12</td> <td>12"</td> <td>OPEN</td> <td>END</td> </tr> <tr> <td>25</td> <td>14"</td> <td>OPEN</td> <td>END</td> </tr> <tr> <td>13</td> <td>16"</td> <td>OPEN</td> <td>END</td> </tr> <tr> <td>14</td> <td>18"</td> <td>OPEN</td> <td>END</td> </tr> <tr> <td>61</td> <td>20"</td> <td>OPEN</td> <td>END</td> </tr> <tr> <td>62</td> <td>22"</td> <td>OPEN</td> <td>END</td> </tr> <tr> <td>63</td> <td>24"</td> <td>OPEN</td> <td>END</td> </tr> </table>	12	12"	OPEN	END	25	14"	OPEN	END	13	16"	OPEN	END	14	18"	OPEN	END	61	20"	OPEN	END	62	22"	OPEN	END	63	24"	OPEN	END	<p>LK</p>  <p>OPEN END</p>
12	12"	OPEN	END																												
25	14"	OPEN	END																												
13	16"	OPEN	END																												
14	18"	OPEN	END																												
61	20"	OPEN	END																												
62	22"	OPEN	END																												
63	24"	OPEN	END																												

Bumpers shown below are for MOUNTING and OPTIONS. To select a style use the two digit outside shape shown above as the last two digits of the part number.

### 1987 TO 2001 VOLVO WHITE SET BACK AXLE W/12" break-back (not available in 12" width)

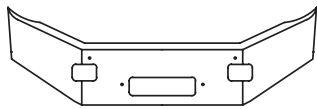

LF-0011-\_\_

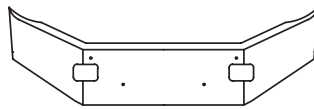

LF-0010-\_\_

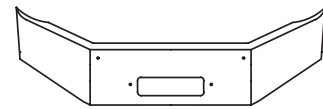

LF-0001-\_\_

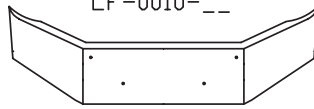

LF-0000-\_\_

### 1991 TO 2001 WG MODEL SET BACK AXLE (brackets included) (will not work on day cabs) SEE LK SERIES FOR DAY CABS

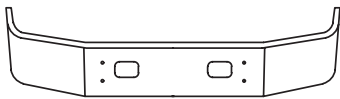

LC-0010-\_\_

Replacement Brackets, if needed:	
13" bumper	LC0115BK
16" bumper	LC0116BK
18" bumper	LC0117BK
20" bumper	LC0134BK

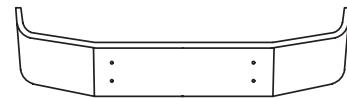

LC-0000-\_\_

### 1991 TO 2001 WG MODEL DAY CAB SET FORWARD AXLE

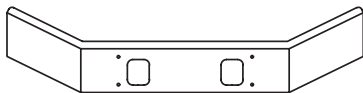

LK-0010-\_\_

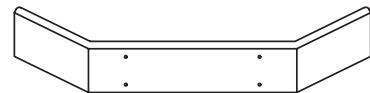

LK-0000-\_\_

### 2006-2008 VT830, VT880 MODEL SET BACK AXLE (not available in widths under 18")

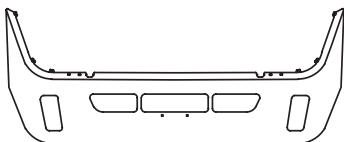

LI-5010-\_\_

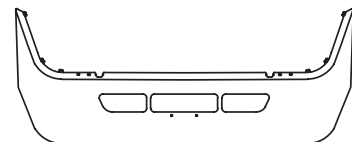

LI-0010-\_\_

**No WARRANTY on break-backs over 18"**

AVAILABLE STYLES (see page 7 for more styles)

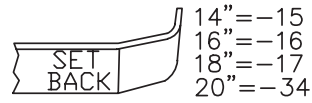

Bumpers shown below are for MOUNTING and OPTIONS. To select a style use the two digit outside shape shown above as the last two digits of the part number.

AERODYNAMIC AIR FOIL AVAILABLE

2018 VNR SET BACK AXLE (brackets included)

LJ-5011-\_\_  
LJ-5010-\_\_  
LJ-5001-\_\_  
LJ-5000-\_\_  
LJ-0011-\_\_  
LJ-0010-\_\_  
LJ-0000-\_\_

LJ-AF  
Airfoil mounts to bottom flange

2018 VNL SET BACK AXLE (brackets included)

LL-5011-\_\_  
LL-5010-\_\_  
LL-5001-\_\_  
LL-5000-\_\_  
LL-0011-\_\_  
LL-0010-\_\_  
LL-0000-\_\_

LL-AF  
Airfoil mounts to bottom flange

**No WARRANTY on break-backs over 18"**

AVAILABLE STYLES (see page 7 for more styles)



Bumpers shown below are for MOUNTING and OPTIONS. To select a style use the two digit outside shape shown above as the last two digits of the part number.

2005 & NEWER VHD SERIES SET FORWARD AXLE  
W/6" BREAK-BACK (BRACKETS AND GRILLE FILLER INCLUDED)  
NOT AVAILABLE WITHOUT VENT HOLES  
16" WIDTH MINIMUM

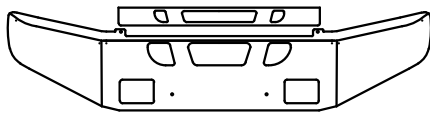

LM-2011-02

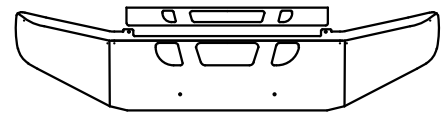

LM-0011-02



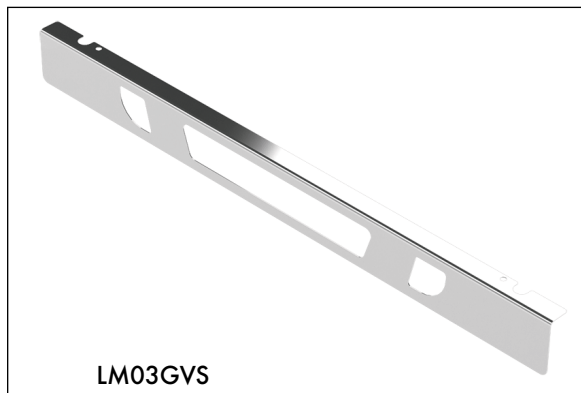

LM-0011 02

OPTIONAL UPGRADED POLISHED STAINLESS GRILLE FILLER TO REPLACE STANDARD POWDER COATED FILLER:



LM03GVS

## AVAILABLE STYLES (see page 7 for more styles)

 TAPERED	12"=-01	 BOXED END	12"=-09	 ROLLED END SQUARE	12"=-04
	16"=-02		16"=-10		16"=-05
	18"=-03		18"=-11		18"=-06
	20"=-31		20"=-51		20"=-41
	22"=-32		22"=-52		22"=-42

Bumpers shown below are for MOUNTING and OPTIONS. To select a style use the two digit outside shape shown above as the last two digits of the part number.

### 1977 TO 1980 COE W/2" break-back (not available in 12" width)

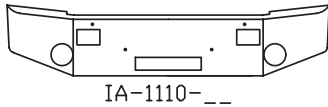

IA-1110-\_\_

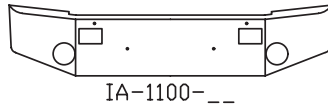

IA-1100-\_\_

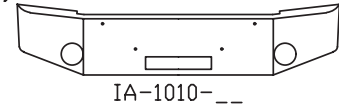

IA-1010-\_\_

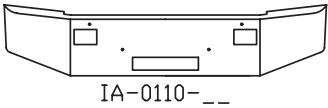

IA-0110-\_\_

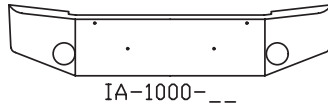

IA-1000-\_\_

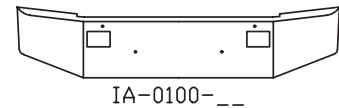

IA-0100-\_\_

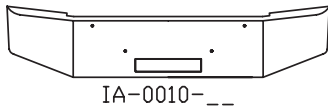

IA-0010-\_\_

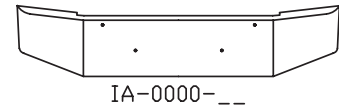

IA-0000-\_\_

### 1967 TO 1984 CONVENTIONAL WESTERN STAR



IB-1010-\_\_



IB-1000-\_\_



IB-0010-\_\_



IB-0000-\_\_

### 1989-2007 CONV. 4900 SERIES, CONSTELLATION, LOWMAXX, HERITAGE

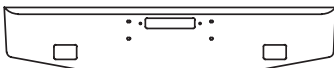

IC-2010-\_\_

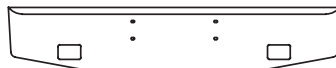

IC-2000-\_\_

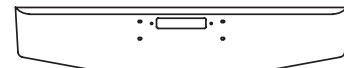

IC-0010-\_\_



IC-2010-06

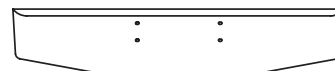



IC-0000-\_\_

NOTE: GLIDER KITS MAY USE THIS SERIES. CHECK CHASSIS YEAR BEFORE ORDERING.

**No WARRANTY on break-backs over 18"**

## AVAILABLE STYLES (see page 7 for more styles)

 TAPERED	12"=-01	 BOXED END	12"=-09	 ROLLED END SQUARE	12"=-04
	16"=-02		16"=-10		16"=-05
	18"=-03		18"=-11		18"=-06
	20"=-31		20"=-51		20"=-41
	22"=-32		22"=-52		22"=-42

Bumpers shown below are for MOUNTING and OPTIONS. To select a style use the two digit outside shape shown above as the last two digits of the part number.

### 1985-1988 WESTERN STAR

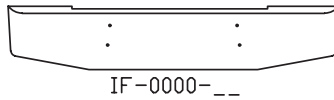
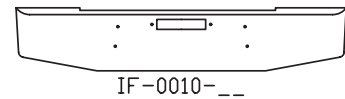
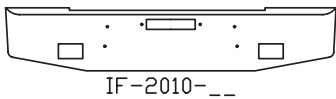

### 2008 AND NEWER 4900 SERIES SET FORWARD (not available in 12")

NOTE: GLIDER KITS MAY USE THIS SERIES. CHECK CHASSIS YEAR BEFORE ORDERING.

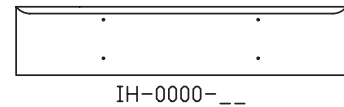
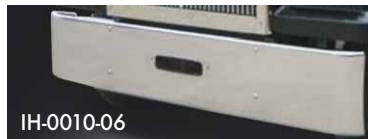
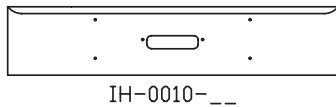
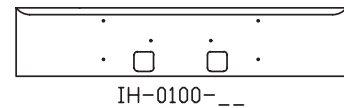
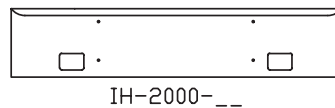
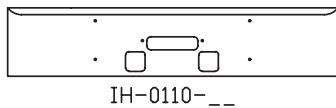
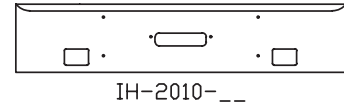
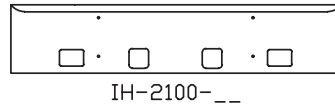
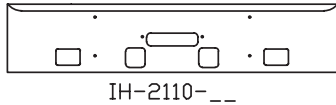

### 2013 AND NEWER 4700SF (not available in 12")

3.88"

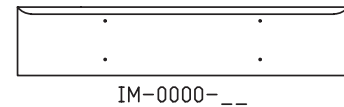
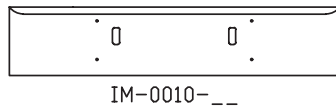
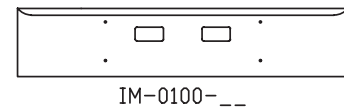
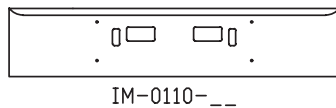
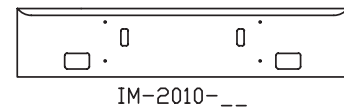
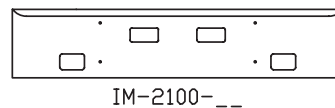
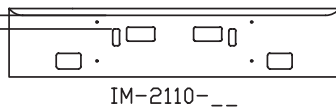

**No WARRANTY on break-backs over 18"**

## AVAILABLE STYLES (see page 7 for more styles)

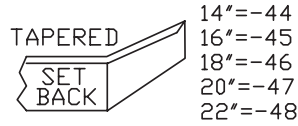

Bumpers shown below are for MOUNTING and OPTIONS. To select a style use the two digit outside shape shown above as the last two digits of the part number.

### 1989 TO 2007 4900SA

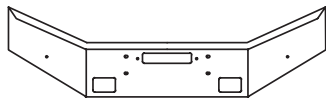

II-2010-\_\_

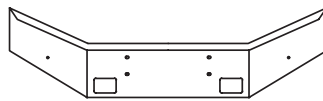

II-2000-\_\_

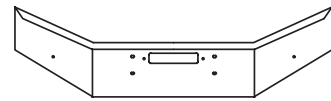

II-0010-\_\_



II-0010-44

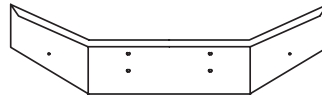

II-0000-\_\_

### 2008 AND NEWER 4900SA WITH OPEN ROLLED ENDS

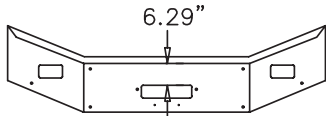

IJ-2010-\_\_

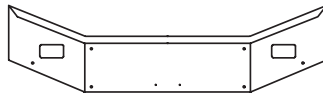

IJ-2000-\_\_

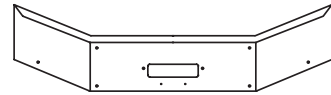

IJ-0010-\_\_



IJ-2010-44

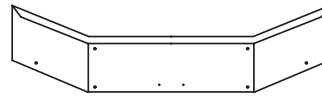

IJ-0000-\_\_

### 2008 AND NEWER 4900SA WITH FULL WRAP ENDS (CHECK CENTER HOLE LOCATION)

ALSO CHECK IL SERIES

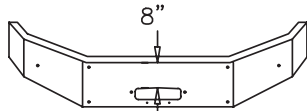

IK-0010-\_\_

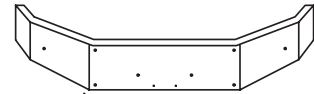

IK-0000-\_\_

### 2008 AND NEWER 4900SA WITH FULL WRAP ENDS (CHECK CENTER HOLE LOCATION)

ALSO CHECK IK SERIES

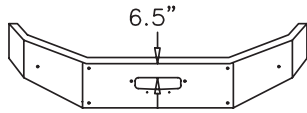

IL-0010-\_\_

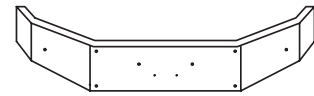

IL-0000-\_\_

**No WARRANTY on break-backs over 18"**

## AVAILABLE STYLES (see page 7 for more styles)

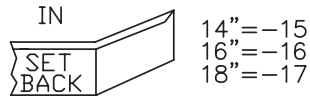

Bumpers shown below are for MOUNTING and OPTIONS. To select a style use the two digit outside shape shown above as the last two digits of the part number

### 2013 AND NEWER WESTERN STAR 4700SB

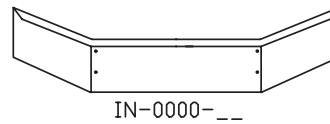
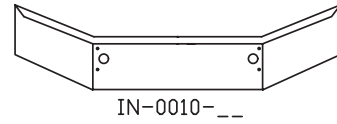
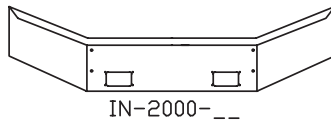
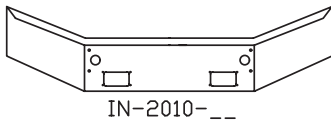

### 2015 AND NEWER 5700XE SERIES SET BACK AXLE (Shown with -V5 front radar cutout) (only fits 1400 sq. in radiator applications)

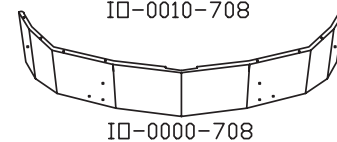
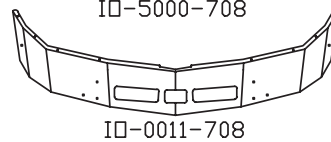
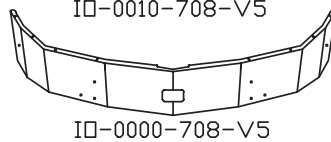
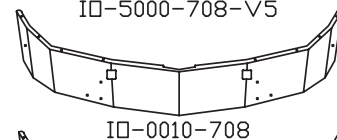
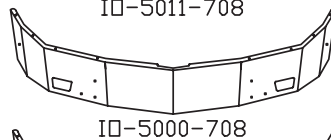
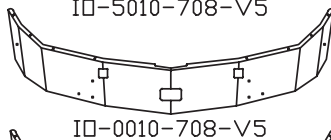
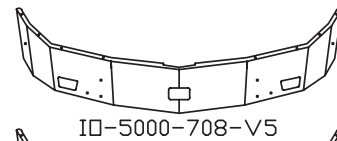
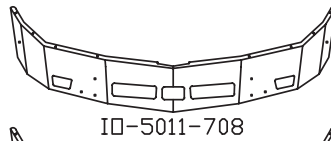
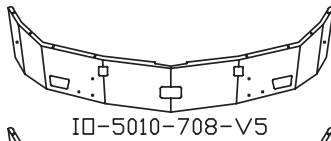

Replacement Brackets, if needed:	
16" bumper	IO01708BK
18" bumper	IO01709BK
20" bumper	IO01711BK

**No WARRANTY on break-backs over 18"**



## AVAILABLE STYLES (see page 7 for more styles)

KA TAPERED	12"=-01	KB WRAP AROUND	12"=-22	KA BOXED END	12"=-09	KA ROLLED END SQUARE	12"=-04		
	16"=-02							16"=-10	16"=-05
	18"=-03							18"=-11	18"=-06
	20"=-31							20"=-51	20"=-41
	22"=-32							22"=-52	22"=-42

Bumpers shown below are for MOUNTING and OPTIONS. To select a style use the two digit outside shape shown above as the last two digits of the part number.

### 1972 TO 1983 ROAD BOSS 2, ROAD COMMANDER 2 (not available in 12" width)

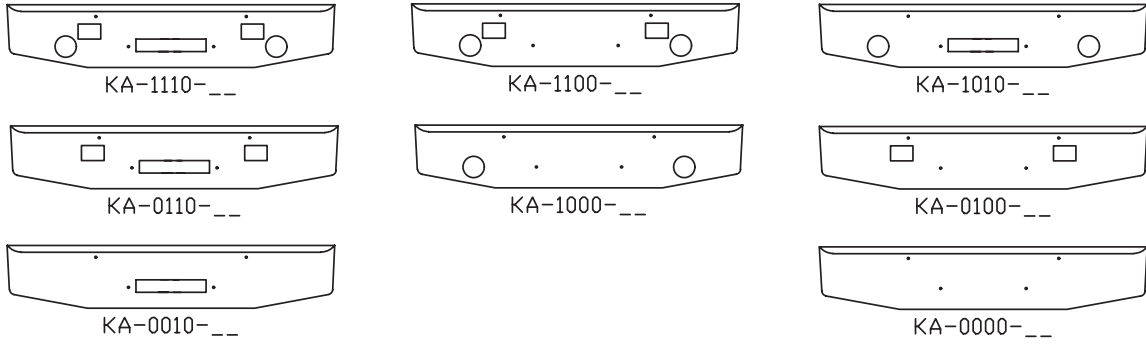

### 1980 TO 2010 COE EXPEDITOR 2 (specify length 88" or 93.75")

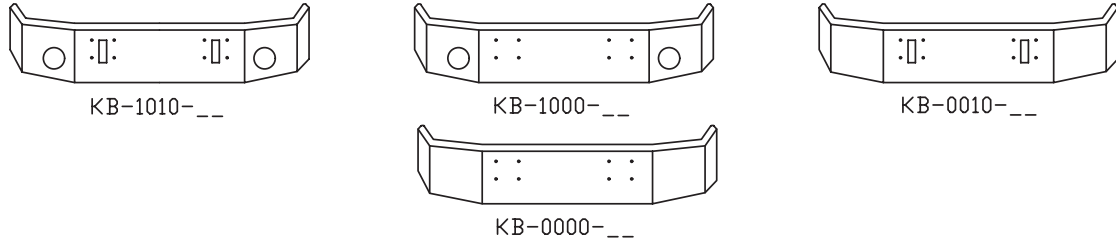

No WARRANTY on break-backs over 18"

## AVAILABLE STYLES

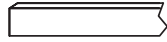

8"=-80

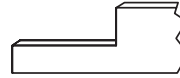

19"=-81

Bumpers shown below are for MOUNTING and OPTIONS. To select a style use the two digit outside shape shown above as the last two digits of the part number.

## REAR LIGHT BARS (brackets included) MIX AND MATCH LIGHTS OR ADD TEXT



MA-XXXX-80-007

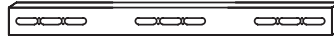

MA-XXXX-80-JC3

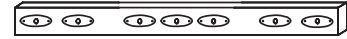

MA-XXXX-80-M7D



MA-XXXX-80-M13



MA-XXXX-80-R10C-R5

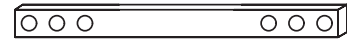

MA-XXXX-80-R6C

## REAR LIGHT PANELS (brackets included) MIX AND MATCH LIGHTS OR ADD TEXT

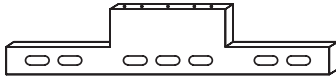

MB-XXXX-81-007

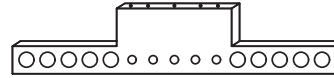

MB-XXXX-81-R10C-R5

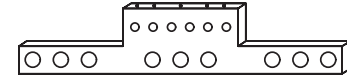

CUSTOM SAMPLE

## REAR LIGHT BAR HALVES (available in stainless steel only)



MD-XXXX-83S-R4C



MD-XXXX-83S-R3C



**AIR DAMS**

AVAILABLE FOR ALL MAKES AND MODELS (standard 4" width)  
LIGHT AND HARNESS KITS AVAILABLE

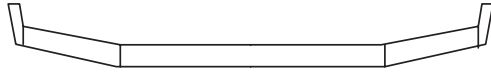

\_\_-SP

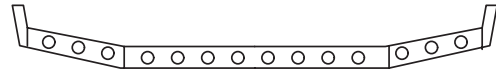

\_\_-SP-R14



\_\_-SP-009



LI-SP-9GA



HZ-SP

**UNIVERSAL MOUNTING PLATES**

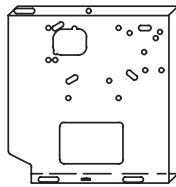

UST\_\_  
FITS FE, FD, HC, HA, CB

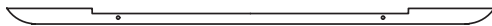

UST TOP LIP

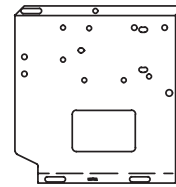

USX\_\_  
FITS CU, CV, HC, HV, IC



USX TOP LIP



**FROM THE ORIGINATORS OF THE BOLTLESS LOOK!**

THESE ARE ONLY A FEW OPTIONS  
MIX AND MATCH YOUR OWN COMBINATIONS  
SEE PAGES 92-96 FOR LED LIGHT INFORMATION

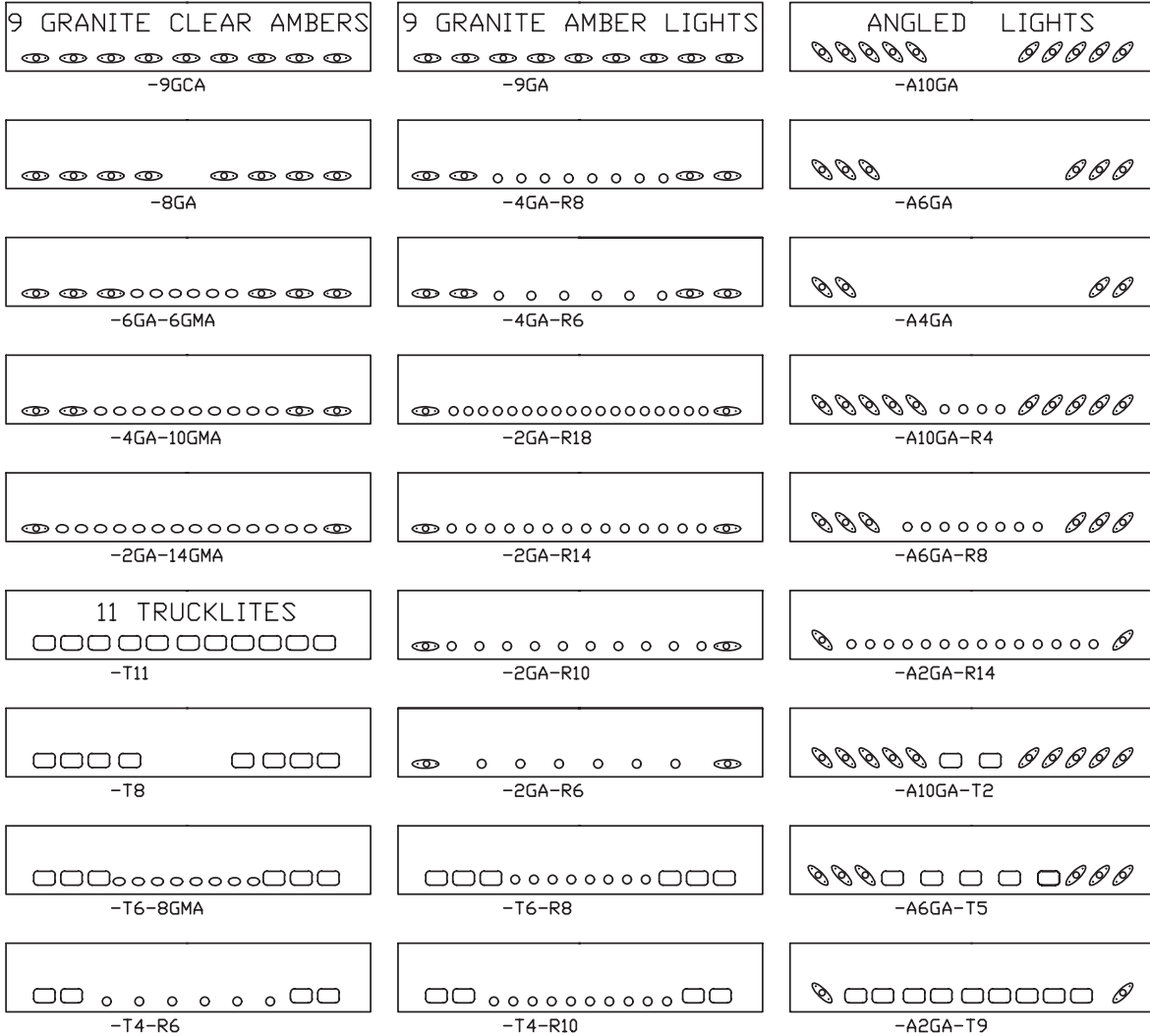

FLA1 = ANGLED FRENCHED LICENSE BOX FL01 = FRENCHED LICENSE BOX

LICENSE PLATE HOLES

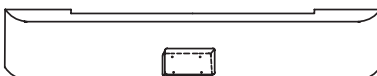

-FLA1

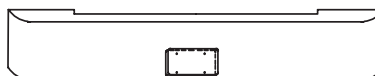

-FL01

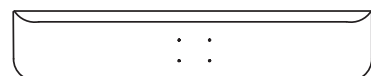

-L01



-FLA1 option shown



-FL01 option shown

THESE ARE ONLY A FEW OPTIONS  
 MIX AND MATCH YOUR OWN COMBINATIONS  
 OVAL LIGHT COMBINATIONS SHOWN BELOW  
 SEE PAGES 92-96 FOR LED LIGHT INFORMATION



\* BOXED END LIGHT OPTIONS \*  
 ADD TO THE END OF THE PART NUMBER

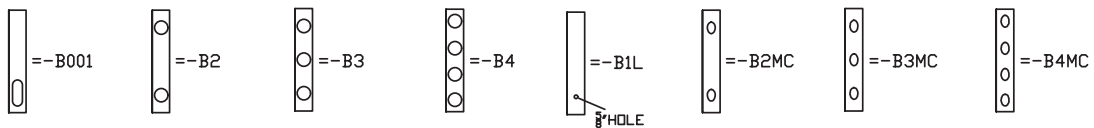

BELOW IS A SAMPLE ORDER FOR A 379 PETE BOXED END WITH 6 OVALS 4 ROUND AND 3 ON THE END

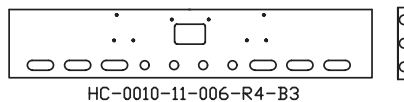



TEXT 1



TEXT 8



TEXT 2



TEXT 9



TEXT 3

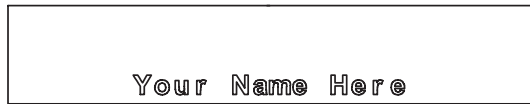

TEXT 10



TEXT 4

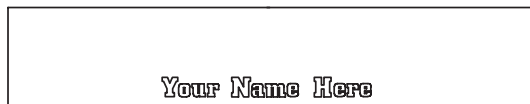

TEXT 11



TEXT 5



TEXT 12



TEXT 6



TEXT 13



TEXT 7



TEXT 14

LIGHT BOXES NOW AVAILABLE TO LIGHT UP YOUR GRAPHIC  
 (Standard widths 40" & 24", mounts behind bumper)  
 (lights and harness included with light box)

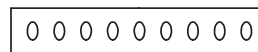

LX-40

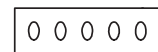

LX-24

24" light box mounted behind Du Pont logo (actual NASCAR hauler)

*Packaged for distributor resale*



- Polished stainless
- Size #12 - 1.75 X 50
- 4- and 8- piece packaged kits
- Nylon washers to protect chrome
- Zinc plated washers & locknuts



VU190080 – four pcs. kit  
VU190082 – eight pcs. kit (shown)





# **UNIVERSAL ACCESSORIES SECTION**

**LED LIGHTING AND STAINLESS PARTS  
TO FIT MOST TRUCK MAKES**





**FLAP WEIGHTS**

WEIGHTS INCLUDE MOUNTING HARDWARE  
EACH SOLD AS A PAIR



**VU190000**  
UNIVERSAL FLAP WEIGHT  
24" - BOTTOM - ANY MAKE  
- 11GA. STAINLESS - GIRLS



**VU190001**  
UNIVERSAL FLAP WEIGHT  
24" - BOTTOM - ANY MAKE  
- 11GA. STAINLESS



**VU190002**  
UNIVERSAL FLAP WEIGHT  
24" TOP - ANY MAKE  
- 11GA. STAINLESS



**VU190003**  
UNIVERSAL FLAP WEIGHT  
- 24" - U SHAPED BOTTOM  
- 11GA. STAINLESS



**VU190102**  
UNIVERSAL FLAP WEIGHT  
- 24" - BOTTOM - ANY MAKE  
- 11GA. STAINLESS - STEER HEAD



**VU190109**  
UNIVERSAL FLAP WEIGHT  
- 24" - U SHAPED BOTTOM  
- 11GA. STAINLESS - STEER HEAD

**TANK STRAPS**



**VU190005**  
9.75" AIR TANK BANDS  
(PB, KW, FL) - PAIR



**VU190061**  
AIR TANK WRAP - FITS 9.75"  
STAINLESS AIR TANK - 1 PC  
COVER ONLY



**VU190006**  
8.25" AIR TANK BANDS  
(PB, KW, FL) - PAIR

**TAG HANGERS**

EACH INCLUDE MOUNTING HARDWARE,  
FOAM PROTECTORS & TAG MOUNTING PLASTIC INSERTS

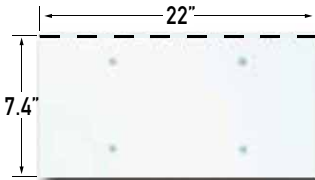

**VP120000**  
HINGED 1 TAG HANGER  
18 GA. STAINLESS  
PETE 389



**VP120001**  
HINGED 1 TAG HANGER  
18 GA. STAINLESS  
PETE 379 & SIMILAR

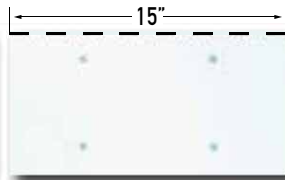

**VP120017**  
HINGED 1 TAG HANGER  
24 GA. STAINLESS  
PETE 379 & SIMILAR

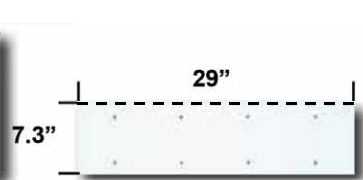

**VU190007**  
HINGED 2 TAG HANGER (PB, KW, FL)



**VU190035**  
TAG HANGER - SINGLE  
TAG - 90 DEGREE  
MOUNTS UNDER  
BUMPER FLANGE



**VU190036**  
TAG HANGER - SINGLE  
2 TAG - 90 DEGREE  
MOUNTS UNDER  
BUMPER FLANGE



**VU190037**  
TAG HANGER - SINGLE  
3 TAG - 90 DEGREE  
MOUNTS UNDER  
BUMPER FLANGE



**VU190008**  
HINGED 3 TAG HANGER (PB, KW, FL)

**PERMIT PANELS**

**HINGED PANELS  
INCLUDES MOUNTING HARDWARE**



**VU190090**  
HINGED PERMIT PANEL  
4 X 4



**VU190091**  
HINGED PERMIT PANEL  
4 X 8



**VU190092**  
HINGED PERMIT PANEL  
4 X 10



**VU190093**  
HINGED PERMIT PANEL  
4 X 12



**VU190094**  
HINGED PERMIT PANEL  
5 X 4



**VU190095**  
HINGED PERMIT PANEL  
5 X 8



**VU190096**  
HINGED PERMIT PANEL  
5 X 10



**VU190097**  
HINGED PERMIT PANEL  
5 X 12

**FLAT PANELS  
INCLUDE STRONG 3M DOUBLE SIDED TAPE**



**VU190098**  
FLAT PERMIT PANEL  
4 X 4 - TAPE MOUNT



**VU190099**  
FLAT PERMIT PANEL  
4 X 8 - TAPE MOUNT



**VU190103**  
FLAT PERMIT PANEL  
4 X 10 - TAPE MOUNT



**VU190104**  
FLAT PERMIT PANEL  
4 X 12 - TAPE MOUNT



**VU190105**  
FLAT PERMIT PANEL  
5 X 4 - TAPE MOUNT



**VU190106**  
FLAT PERMIT PANEL  
5 X 8 - TAPE MOUNT

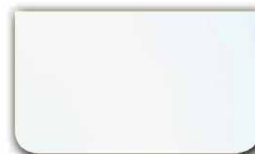

**VU190107**  
FLAT PERMIT PANEL  
5 X 10 - TAPE MOUNT

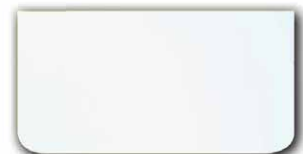

**VU190108**  
FLAT PERMIT PANEL  
5 X 12 - TAPE MOUNT

**RIDGED PERMIT PANELS**

90-DEGREE BEND AT TOP, NO-HINGE  
INCLUDES MOUNTING HARDWARE  
CUSTOMER DRILLS TO FIT



**VU190110**  
RIDGED PERMIT PANEL  
4 X 4



**VU190111**  
RIDGED PERMIT PANEL  
4 X 8



**VU190112**  
RIDGED PERMIT PANEL  
4 X 10



**VU190113**  
RIDGED PERMIT PANEL  
4 X 12



**VU190114**  
RIDGED PERMIT PANEL  
5 X 4



**VU190115**  
RIDGED PERMIT PANEL  
5 X 8

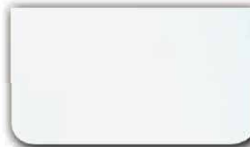

**VU190116**  
RIDGED PERMIT PANEL  
5 X 10



**VU190117**  
RIDGED PERMIT PANEL  
5 X 12

**BEACON LIGHT BRACKETS**

INCLUDES MOUNTING HARDWARE



**VU190100**  
BEACON LIGHT BRACKET  
8" X 8" - PR

**AIRLINE BOXES**

MOUNTING HARDWARE INCLUDED  
AIR LINE BOXES ARE 32" LONG - CLOSED BACK  
NOT AVAILABLE IN 430 STAINLESS



**VU190015**  
AIR LINE BOX - STANDARD



**VU190016**  
AIR LINE BOX - 2-PLUG



**VU190015R**  
AIR LINE BOX - STANDARD - ROUNDED



**VU190016R**  
AIR LINE BOX - 2-PLUG - ROUNDED

**TO BUILD A LIGHT BOX**

- 1- PICK BLANK PART NUMBER
- 2- PICK LIGHT TYPE (REFER TO PAGE 92-93)
- 3- PICK THE NUMBER OF LIGHTS

**EXAMPLE: VU190016R-2CA**

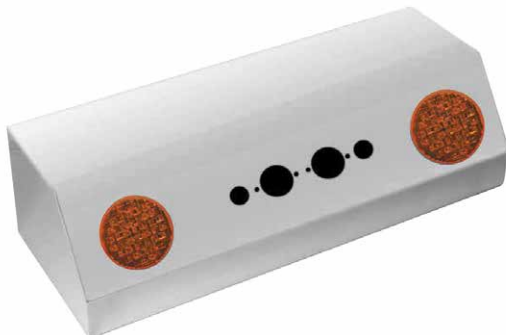

**DECK PLATES**



**VU190017**  
DECK PLATE - 36" X 34" - SMOOTH  
STAINLESS - OVER FRAME RAILS



**VU190018**  
DECK PLATE - 48" X 34" - SMOOTH  
STAINLESS - OVER FRAME RAILS



**VU190067**  
REAR DECK PLATE - SMOOTH - 29" X 33" -  
ROLLED EDGES - OVER FRAME RAILS



**VU192010-**  
DECK PLATE - FRONT DECK PLATE 11G  
SS 83" X 27" - BETWEEN FRAME RAILS



**VU192011**  
DECK PLATE - MID DECK PLATE 11G SS  
44" X 27" - BETWEEN FRAME RAILS

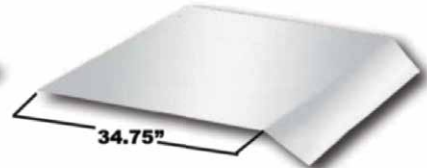

**VU192012**  
DECK PLATE - REAR DECK PLATE 11GSS  
48" X 27" - BETWEEN FRAME RAILS



**VU192022**  
DECK PLATE - MID DECK PLATE 11GSS  
77X27 - BETWEEN FRAME RAILS

**FRONT DECK PLATE TOOL BOX**

**VU19201**  
UNIVERSAL FRONT DECK PLATE TOOL  
BOX - W/LOCK - 24" X 24"



Open



Closed

**HEAD LIGHT VISORS**



**VU190009**  
HEAD LIGHT VISOR - DOUBLE -  
PB, KW, FL



**VU190010**  
HEAD LIGHT VISOR - SINGLE -  
PB, KW, FL

**BENT & NOTCHED  
MOUNTING HARDWARE INCLUDED**



**FRAME STEPS**

*INCLUDES SLIP RESISTANT GRIP TAPE*



**VU191103**  
FRAME STEPS - 12"  
STAINLESS STEPS & SIDES

**VU191104**  
FRAME STEPS - 18"  
STAINLESS STEPS & SIDES

**VU191105**  
FRAME STEPS - 24"  
STAINLESS STEPS & SIDES

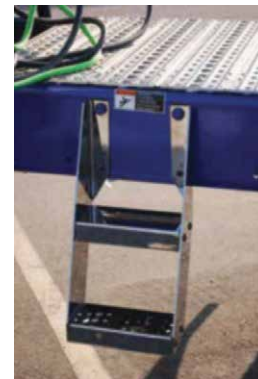

**VU191106**  
FRAME STEPS - 12"  
ALUMINUM

**VU191107**  
FRAME STEPS - 18"  
ALUMINUM

**VU191108**  
FRAME STEPS - 24"  
ALUMINUM

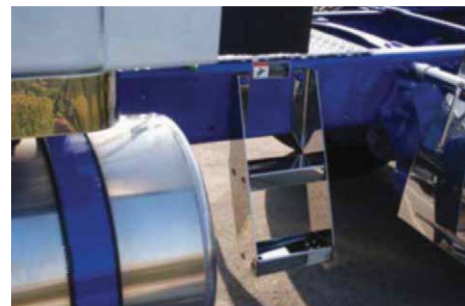

**REAR WINDOW VISORS**

**NOT AVAILABLE ON DAYCAB**

INCLUDES STRONG 3M DOUBLE-SIDED TAPE AND MOUNTING HARDWARE



**VU190020**  
DEEP BACK WINDOW VISOR -  
40" WIDE X 7" DEEP -PB,KW,FL



**VU193020**  
REAR VISOR GANGSTER



**VU193020-BF**  
REAR VISOR GANGSTER -  
BUTTERFLY



**VU193020-BT**  
REAR VISOR GANGSTER -  
BOWTIE



**VU195020**  
REAR VISOR WICKED -  
ONE PIECE



**EXAMPLE**  
**VU193020-P**  
REAR VISOR GANGSTER

**PAINTABLE  
VISORS  
AVAILABLE**

JUST ADD "P" TO THE END  
FOR PAINTABLE

RAW18 GAUGE STEEL  
COLORS SHOWN EXAMPLES ONLY



**EXAMPLE**  
**VU193020P-BF**  
REAR VISOR GANGSTER -  
BUTTERFLY

**REAR FRAME FILLERS**

**BOXES COME WITH VU190201 BACK COVER**

18-GAUGE STAINLESS STEEL MOUNTING HARDWARE INCLUDED



**VU190200**  
REAR FRAME FILLER - BLANK



**VU190201**  
REAR FRAME FILLER  
BACK COVER



**VU190202**  
REAR FRAME FILLER - 4 - 4"  
RD - LEDS / EACH CORNER



**VU190203**  
REAR FRAME FILLER - 4 - 4"  
RD / 5 - 2" RD - LEDS

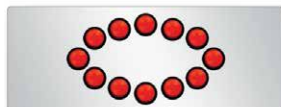

**VU190204**  
REAR FRAME FILLER - 12 - 2"  
RD - LEDS / OVAL



**VU190205**  
REAR FRAME FILLER - 2 - 4"  
RD / 8 - 2" RD - LEDS



**VU190206**  
REAR FRAME FILLER - 2 - 4"  
RD / 3 - GRANITE RED - LEDS



**VU190207**  
REAR FRAME FILLER - 4 - 4"  
RD / 5 - 2" RD - LEDS -  
W / STEERHEAD



**REAR FRAME FILLERS**

NOT AVAILABLE ON DAYCAB

INCLUDES STRONG 3M DOUBLE-SIDED TAPE AND MOUNTING HARDWARE



**VU190208**  
REAR FRAME FILLER - 2 - 4"  
RD / 3 - GRANITE-LEDS -  
W / STEERHEAD



**VU190209**  
REAR FRAME FILLER - 4 - 4"  
RD - LEDS - CLEAR LENS /  
EACH CORNER

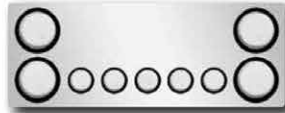

**VU190210**  
REAR FRAME FILLER - 4 - 4"  
RD / 5 - 2" RD - LEDS -  
CLEAR LENS



**VU190211**  
REAR FRAME FILLER - 12 - 2"  
RD - LEDS - CLEAR LENS /  
OVAL



**VU190212**  
REAR FRAME FILLER - 2 - 4"  
RD / 8 - 2" RD - LEDS -  
CLEAR LENS



**VU190213**  
REAR FRAME FILLER - 2 - 4"  
RD / 3 - GRANITE - LEDS -  
CLEAR LENS



**VU190214**  
REAR FRAME FILLER - 4 - 4"  
RD / 5 - 2" RD - LEDS - CLEAR  
LENS - W / STEERHEAD

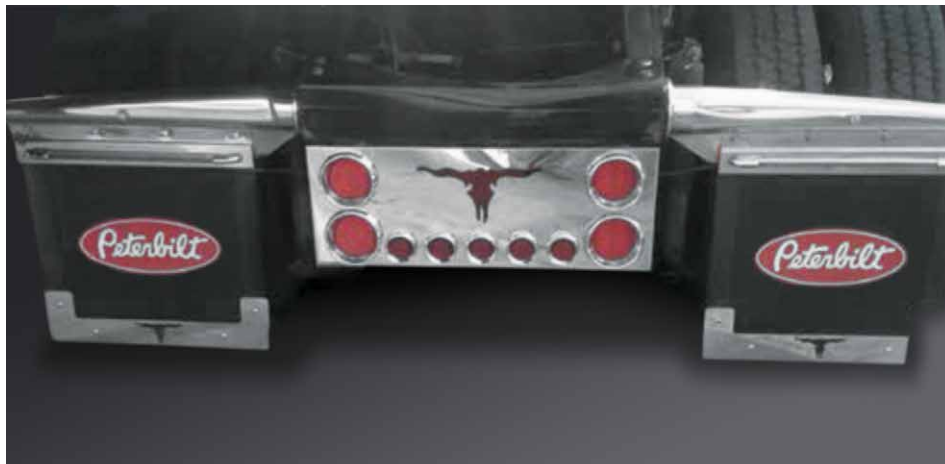

**VU190214-4CR-5RR**  
(chrome light bezels not included)

Mud flap weights VU190109 also shown



**LOWER REAR FRAME FILLERS**



**VU199002**  
LOWER REAR FRAME FILLER -  
- BLANK



**VU199005**  
LOWER REAR FRAME FILLER -  
379 - BLANK



**VU199002-4CN**  
LOWER REAR FRAME FILLER -  
4 ROUND CUTOUTS

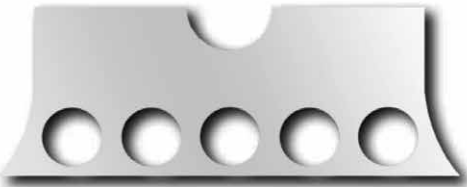

**VU199002-5CN**  
LOWER REAR FRAME FILLER -  
5 ROUND CUTOUTS



**VU199002-5CR shown, includes lights and harness**  
**CHROME LIGHT BEZELS NOT INCLUDED**  
**WILL NOT WORK ON ALUMINUM FRAMES**

**RETAIL DISPLAY - LEDs**

For authorized distributors

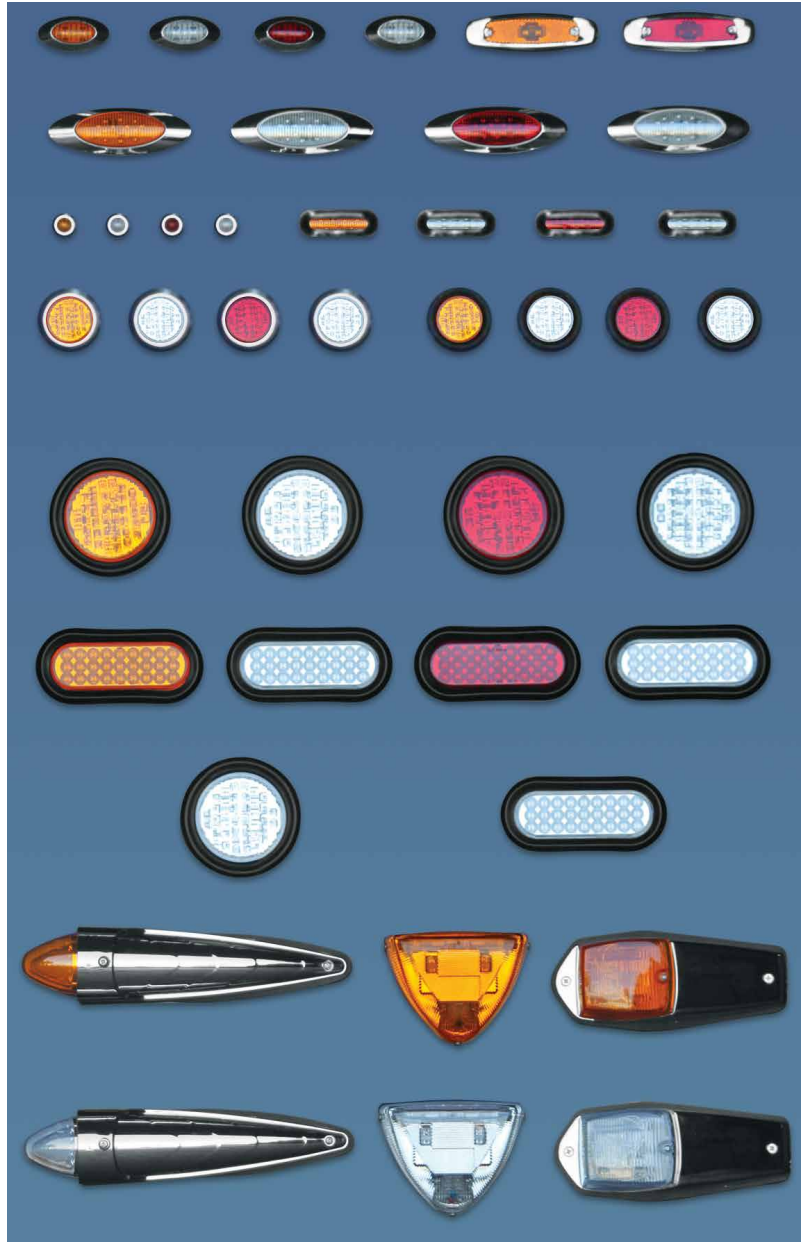

**2 PACKAGES AVAILABLE:**

**PART# VULIGHTKIT3 FOR 12 OF EACH LIGHT AND DISPLAY BOARD**

**PART# VULIGHTKIT4 FOR 24 OF EACH LIGHT AND DISPLAY BOARD**

Actual light display board may vary from illustration above.

**LED LIGHT OPTION CHART**

Use the following light chart to build your rear light bars, cab and sleeper panels, hood extension panels, and so on. Use the first letter in the name of the light and the form you wish the light to be.

Solid Accessory Part Number	Dash	Amount of Lights	Lights name - 1st letter	Lights Color	=	Complete Part Number with Lights
Vxxxxxxx	-	X	X	X	=	Vxxxxxxx-XXX
VP142007	-	7	G	CA	=	VP142007-7GCA

**EXAMPLE:**



**VP142007-7GCA**

Peterbilt 379 cab panel VP142007, with seven Granite clear lens amber LED light assemblies & wire harness

**LIGHT OFFERINGS WITH LETTER AND LIGHT COLOR CODES:**

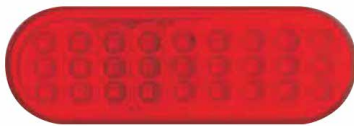

**OVAL 6"**

Amber lens, Amber LEDs = O A  
 Clear lens, Amber LEDs = O CA  
 Red lens, Red LEDs = O R  
 Clear lens, Red LEDs = O CR



**GRANITE**

Amber lens, Amber LEDs = G A  
 Clear lens, Amber LEDs = G CA  
 Red lens, Red LEDs = G R  
 Clear lens, Red LEDs = G CR



**GRANITE MINI**

Amber lens, Amber LEDs = GM A  
 Clear lens, Amber LEDs = GM CA  
 Red lens, Red LEDs = GM R  
 Clear lens, Red LEDs = GM CR



**ROUND 2"**

Amber lens, Amber LEDs = R A  
 Clear lens, Amber LEDs = R CA  
 Red lens, Red LEDs = R R  
 Clear lens, Red LEDs = R CR

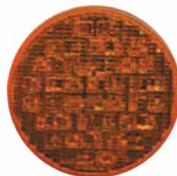

**CORAL 4" ROUND**

Amber lens, Amber LEDs = C A  
 Clear lens, Amber LEDs = C CA  
 Red lens, Red LEDs = C R  
 Clear lens, Red LEDs = C CR



**BULLSEYE 3/4" ROUND**

Amber lens, Amber LEDs = BY A  
 Clear lens, Amber LEDs = BY CA  
 Red lens, Red LEDs = BY R  
 Clear lens, Red LEDs = BY CR

## BLANK LIGHT CUTOUT OPTIONS

Add your own lights to our accessories, but first get the correct cutouts:

Solid Accessory Part Number	Dash	Amount of Lights	Lights name - 1st letter	Lights Color	=	Complete Part Number with Lights
Vxxxxxxx	-	X	X	X	=	Vxxxxxxx-XXX
VP142007	-	10	BY	N	=	VP142007-10BYN

**EXAMPLE:**



**VP142007-10BYN**

Peterbilt 379 cab panel VP142007, with ten open 3/4" light holes

### CUTOUT CODES:

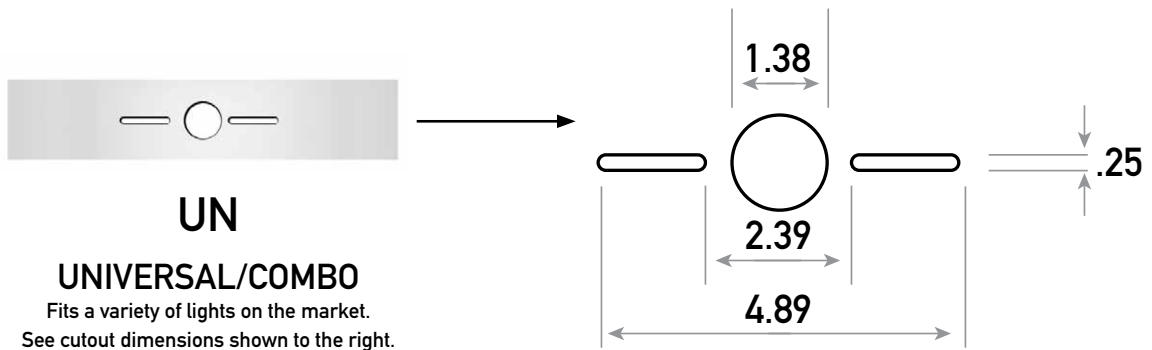

**SN**

**OVAL SLOTTED**

Mount your 6" oval light with double-sided tape behind the cutout



**RN**

**2" ROUND**



**BYN**

**3/4" ROUND**

"N" LIGHT COLOR INDICATES NO LIGHTS/OPEN CUTOUT

**3-YEAR WARRANTY**

**LED LIGHTS**

**VU-860L**  
**2" Round**



VU-860L-A shown

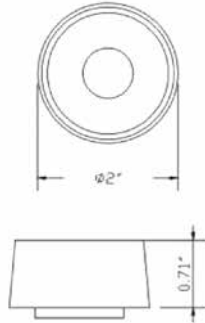

- 9 LEDs
- 12 volt
- Sonically sealed polycarbonate lens & housing
- Epoxy encapsulated electronics and sealed wire entry prevent dirt and moisture from entering the light
- Includes a rubber grommet when ordered as a kit with bumper or accessory

Part Numbers	Lens Color	LED Color
VU-860L-A	Amber	Amber
VU-860L-CA	Clear	Amber
VU-860L-R	Red	Red
VU-860L-CR	Clear	Red

**3-YEAR WARRANTY**

**VU-924-1L**  
**4" ROUND**  
**"CORAL"**

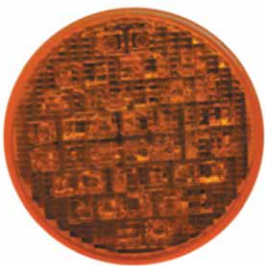

VU-924-1L-A shown



- 40 LEDs
- 12 volt or 24 volt
- Chrome reflector for brilliant light emission
- Sonically sealed polycarbonate lens & housing
- Epoxy encapsulated electronics and sealed wire entry prevent dirt and moisture from entering the light
- Includes a rubber grommet when ordered as a kit with bumper or accessory

Part Numbers	Lens Color	LED Color
VU-924-1L-A	Amber	Amber
VU-924-1L-CA	Clear	Amber
VU-924-1L-R	Red	Red
VU-924-1L-CR	Clear	Red
VU-924-1L-CW	Clear	White

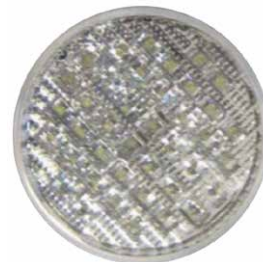
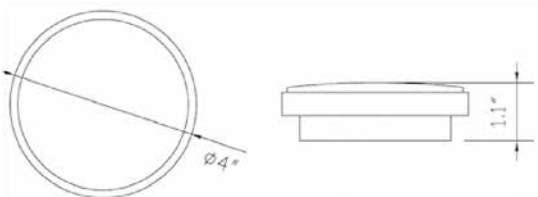

VU-924-1L-CW shown

**SIGNATURE MARKER LIGHTS**

**3-YEAR WARRANTY**



**VU-1080L  
GRANITE**

VU-1080L-A shown



Part Numbers	Lens Color	LED Color
VU-1080L-A	Amber	Amber
VU-1080L-CA	Clear	Amber
VU-1080L-R	Red	Red
VU-1080L-CR	Clear	Red

- 6 LEDs
- 12 volt
- Sonically sealed polycarbonate lens & housing
- Epoxy encapsulated electronics and sealed wire entry prevent dirt and moisture from entering the light
- Includes chrome bezel



**VU-7160L  
GRANITE MINI**

VU-7160L-A shown

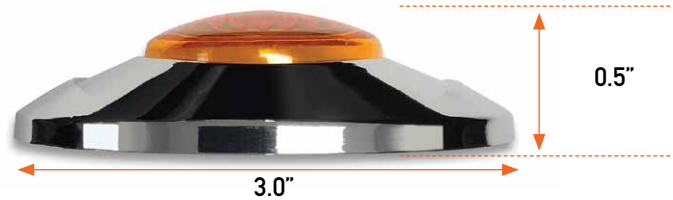

Part Numbers	Lens Color	LED Color
VU-7160L-A	Amber	Amber
VU-7160L-CA	Clear	Amber
VU-7160L-R	Red	Red
VU-7160L-CR	Clear	Red

**3-YEAR WARRANTY**

- 3 LEDs
- 12 volt
- Sonically sealed polycarbonate lens & housing
- Epoxy encapsulated electronics and sealed wire entry prevent dirt and moisture from entering the light
- Includes chrome bezel



3-YEAR WARRANTY

LED LIGHTS

VU-998-1L  
3/4" ROUND  
"BULLSEYE"



VU-998-1L-CA shown

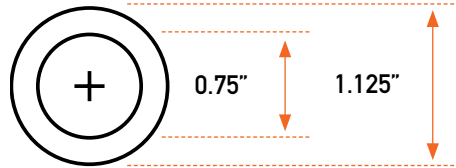

- 3 LEDs
- 12 volt
- Sonically sealed polycarbonate lens & housing
- Epoxy encapsulated electronics and sealed wire entry prevent dirt and moisture from entering the light
- Includes chrome bezel

Part Numbers	Lens Color	LED Color
VU-998-1L-A	Amber	Amber
VU-998-1L-CA	Clear	Amber
VU-998-1L-R	Red	Red
VU-998-1L-CR	Clear	Red

3-YEAR WARRANTY

VU-968-1L  
6" OVAL



VU-968-1L-R shown

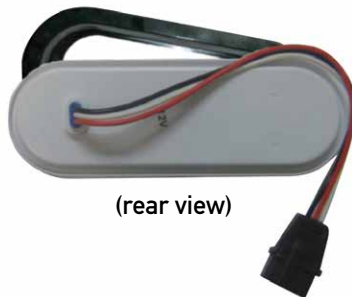

(rear view)



VU-968-1L-A shown with ABS snap ring



VU-968-1L-CW shown

- 21 Super LEDs
- 12 volt
- Chrome reflector for brilliant light emission
- Sonically sealed polycarbonate lens & housing
- Epoxy encapsulated electronics and sealed wire entry prevent dirt and moisture from entering the light
- Includes an ABS plastic snap-ring and rubber grommet when ordered as a kit with bumper or accessory

Part Numbers	Lens Color	LED Color
VU-968-1L-A	Amber	Amber
VU-968-1L-CA	Clear	Amber
VU-968-1L-R	Red	Red
VU-968-1L-CR	Clear	Red
VU-968-1L-CW	Clear	White

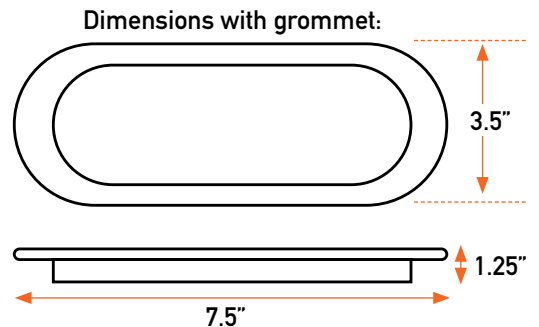

**LED LIGHTS**

**3-YEAR WARRANTY**

**VU-949-1L**

**“TORPEDO” CAB MARKER**



VU-949-1L-A shown

- 19 LEDs
- 12 volt
- Chrome reflector for brilliant light emission
- Bright chrome outer housing
- Rubber mounting pad
- Sonically sealed polycarbonate lens & housing
- Epoxy encapsulated electronics and sealed wire entry prevent dirt and moisture from entering the light
- Includes chrome bezel

Part Numbers	Lens Color	LED Color
VU-949-1L-A	Amber	Amber
VU-949-1L-CA	Clear	Amber

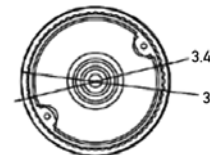
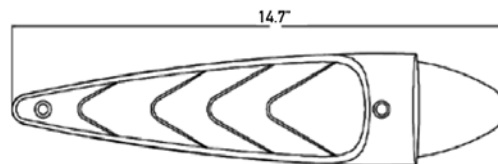

VU-855L-A shown

**VU-855L**

**VINTAGE CAB MARKER**

**3-YEAR WARRANTY**

- 36 LEDs
- 12 volt
- Bright chrome outer housing
- Sonically sealed polycarbonate lens & housing
- Epoxy encapsulated electronics and sealed wire entry prevent dirt and moisture from entering the light
- Includes chrome bezel

Part Numbers	Lens Color	LED Color
VU-855L-A	Amber	Amber
VU-855L-CA	Clear	Amber

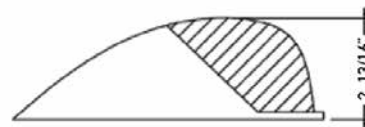
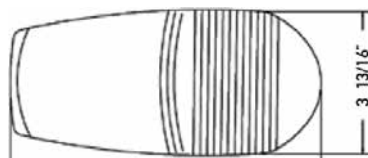



**3-YEAR  
WARRANTY**

**PETE TURN/PARK/CLEARANCE LIGHT**

**VU-951L  
6" x 5" CLEARANCE**

- 31 Super LEDs
- 12 volt
- Sonically sealed polycarbonate lens & housing
- Epoxy encapsulated electronics and sealed wire entry prevent dirt and moisture from entering the light

Part Numbers	Lens Color	LED Color
VU-951L-A	Amber	Amber
VU-951L-CA	Clear	Amber



VU-951L-A shown

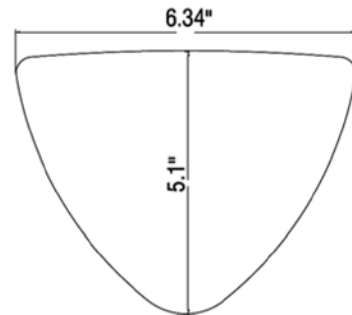
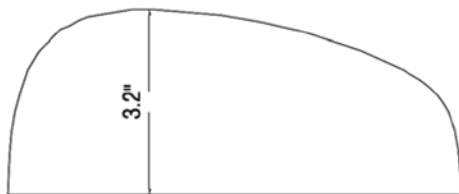

**WIRE HARNESSES**

**VU-877F**

**FEMALE HARNESS**

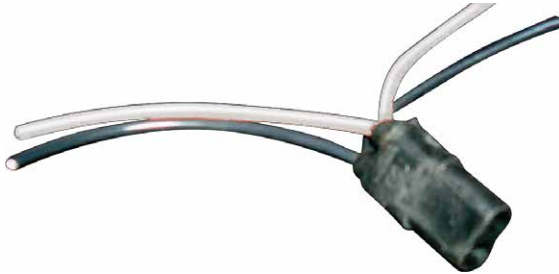

- 2 female bullets
- 100 ft. length
- Available in 4", 6", 8" or 10" spacing – see part numbers

Part Numbers	Bullet spacing
VU-877F-4	4"
VU-877F-6	6"
VU-877F-8	8"
VU-877F-10	10"

**VHMS3007**

**AIR CLEANER LIGHT BOX HARNESS**



- See pages 110, 118, 150 for air cleaner light boxes
- One PACCAR female end
- Two PACCAR male ends



**PETERBILT MODEL 359**



# **PETERBILT MODEL 359**

## **CAB PANEL 3.5"**

*MOUNTING HARDWARE INCLUDED*



**VP110235**  
PB CAB PANELS - 359 -  
STANDARD BLANK - PAIR

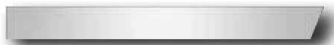

**VP110238**  
PB CAB PANEL, EXT. PANEL  
FORMED 359 2PC. STANDARD  
WRAP BLANK - PAIR



**VP110236**  
PB CAB PANELS - 359 -  
STANDARD WRAP BLANK - PAIR



VP110236 shown

*BUILD A CUSTOM PANEL – SEE PAGES 92-93*

## **HOOD EXTENSIONS**



**VP110319**  
PB - 359 HOOD EXTENSION  
PANEL - FACTORY





# **PETERBILT MODEL 359**

## **MISC. TRIM PIECES**



**VP110023**  
PB 359 TOP OF DOOR TRIM - LOWERED LOOK - 359  
CUSTOM HEIGHTS AVAILABLE



VP110023-P FOR PAINTABLE



**VP110027**  
PB 359 WINDSHIELD WIPER ARM COVERS



**VP120113**  
PB BUG SHIELD - STAINLESS  
- 359  
MOUNTING HARDWARE INCLUDED



**VP120504**  
PB 359 FENDER SUPPORT  
COVER - FRONT - BLANK



RUBBER TRIM AND MOUNTING  
HARDWARE INCLUDED

## **PETERBILT MODEL 359**

### **STANDARD MOUNT STAINLESS VISORS**



**VP130001**

PB - 359 12" DROP VISOR - ANY YEAR 359

**PAINTABLE  
VISORS  
AVAILABLE**

JUST ADD "P" TO THE END  
FOR PAINTABLE. EXAMPLE:

**VP130001-P**  
RAW 18 GAUGE STEEL

*BUILD A CUSTOM VISOR— SEE PAGES 92-93*

**FOR MORE PETE VISORS SEE PAGES 182-185**

### **GANGSTER STAINLESS VISORS**



**VP132001**

PB - 12" GANGSTER VISOR - 359 2 PC



**VP132001-BT**

PB - 12" GANGSTER BOWTIE VISOR - 359 2 PC



**VP132001-BF**

PB - 12" GANGSTER BUTTERFLY VISOR - 359 2 PC



**VP132001-RBF**

PB - 12" GANGSTER VISOR - 359 2 PC

**VP132001P-RBF**

PB - 12" GANGSTER VISOR - 359 - PAINTABLE 2 PC

### **WICKED VISORS**



**VP135001**

PB - 12" WICKED - DROP VISOR -  
ANY YEAR 359 - 2 PC

# **PETERBILT MODEL 359**

## **AIR DEFLECTORS**



**VP110016**

PB 359 - 379, 389 WINDOW AIR DEFLECTORS



**VP110031**

PB 359 - 379, 389 WINDOW  
AIR DEFLECTORS W/LOWER  
LOOKS( VP110017 )WINDOW  
TRIM 37.25" X 20.375"

## **FUEL TANK STRAP COVERS**

*BRACKETS & MOUNTING HARDWARE INCLUDED*



**VP150039**

PB 359 - FUEL TANK STRAP  
COVERS - 2PCS



**PETERBILT MODEL 359**

**MISC. TRIM PIECES**

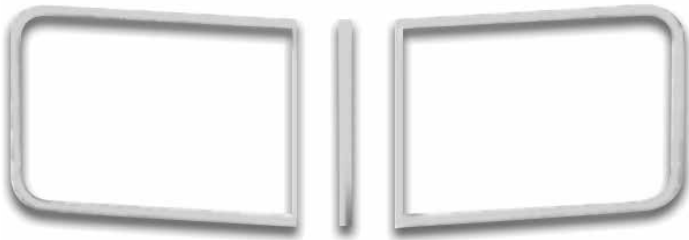

**VP110024**  
PB WINDSHIELD TRIM - 3 PC 359 -  
STANDARD - 430 STAINLESS



**VP110012**  
359, 379 DOOR FLAME  
TRIM - PAIR





**PETERBILT MODELS 365 & 367**



# PETERBILT MODELS 365 & 367

## CAB PANELS 4"

MOUNTING HARDWARE INCLUDED

**VP110241**

PB CAB PANELS - 2005 &  
NEWER - 367, 365 - BLANK  
WRAP - SET BACK ONLY

ADD LIGHT OPTIONS TO A PART NUMBER

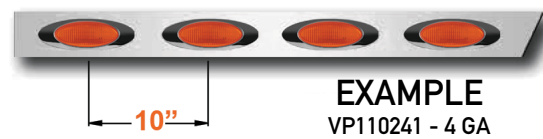
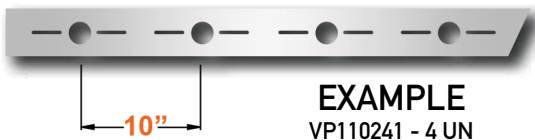

BUILD A CUSTOM PANEL – SEE PAGES 92-93



# PETERBILT MODELS 365 & 367

## SLEEPER PANELS 4"

MOUNTING HARDWARE INCLUDED  
MATCH TO SLEEPER EXTENSION PANELS ON NEXT PAGE



**VP142064**  
PB SLEEPER PANELS - 367,  
365 - 36"/44" - BLANK



**VP142065**  
PB SLEEPER PANELS - 367,  
365 - 48" - BLANK



**VP142066**  
PB SLEEPER PANELS - 367,  
365 - 63"/72" - BLANK



**VP142067**  
PB SLEEPER PANELS - 367,  
365 - 70" - BLANK

*ADD LIGHT OPTIONS:*



**EXAMPLE**  
VP142065 - 5 UN



**EXAMPLE**  
VP142065 - 5 RN



**EXAMPLE**  
VP142067 - 8 RA

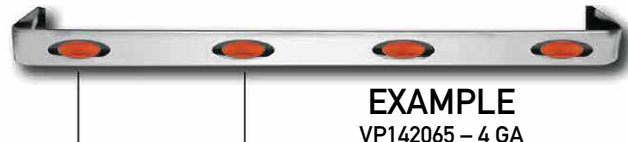

**EXAMPLE**  
VP142065 - 4 GA

**BUILD A CUSTOM PANEL – SEE PAGES 92-93**



# PETERBILT MODELS 365 & 367

## SLEEPER EXTENSION PANELS 4"

MOUNTING HARDWARE INCLUDED

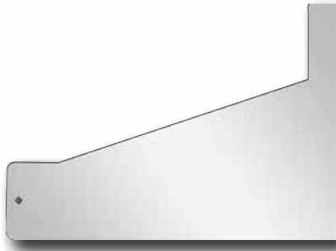

**VP142101**  
PB SLEEPER EXTENSION  
PANEL - 1987 & NEWER - 384,  
379, 388, 389 - 63"/72" - BLANK,  
365, 367

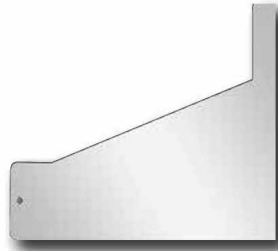

**VP142103**  
PB SLEEPER EXTENSION  
PANEL - 1987 & NEWER - 384,  
379, 388, 389 - 70"/80" - BLANK,  
365, 367



*ADD LIGHT OPTIONS:*

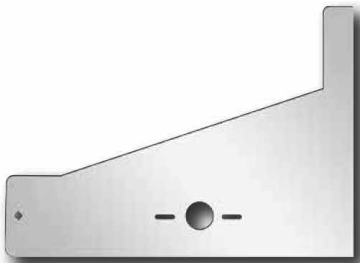

**EXAMPLE**  
VP142101-1UN

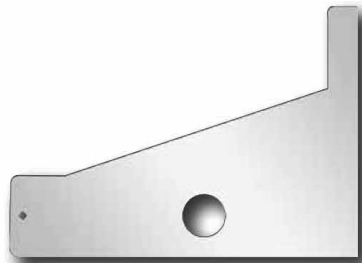

**EXAMPLE**  
VP142101-1RN



**EXAMPLE**  
VP142101-1GA

*BUILD A CUSTOM PANEL – SEE PAGES 92-93*



# PETERBILT MODELS 365 & 367

## AIR CLEANER LIGHT BOXES

CONNECTS TO AIR CLEANER STRAP

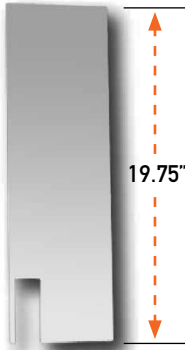

**VP112118**

PB - AIR CLEANER LIGHTS - BLANK - 367, 365 - 2005 & NEWER - SET BACK AXLE ONLY - PAIR

*CUSTOM EXAMPLE:*

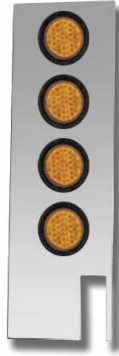

**VP112118-4RA**

PB - AIR CLEANER LIGHTS - 4 ROUND AMBERS - 367, 365 - 2005 & NEWER - SET BACK AXLE ONLY - PAIR

*Don't Forget the Light Harness:*



**VHMS3007**

1 - PACCAR - FEMALE 2 - PACCAR - MALE - FOR CONNECTING FRONT & REAR AIR CLEANER LIGHTS

**BUILD A CUSTOM PANEL – SEE PAGES 92-93**

## BUG SHIELDS



**VP120110**

PB BUG SHIELD - STAINLESS - 367, 388, 389

MOUNTING HARDWARE INCLUDED



**W I N G M A S T E R**



**PETERBILT MODELS 379 & 389**



- 1 VP132002P** Gangster visor, 12", paintable
- 2 VP110018** Windshield trim kit -large
- 3 VP120502** Front blinker bars (pair) with LEDs  
Similar: VP120501 for model 379
- 4 VP110228** Cab panels –extended wrap  
Shown with four slotted light holes (VP110228-4S)
- 5 VP110308** Hood extension panel – wide replacement  
Shown with three slotted light holes (VP110308-3S)
- 6 VP150011R** Fuel tank fairings (pair), rounded style, 64" long
- 7 VP142000** 4" sleeper panels (pair) for 63"/72" sleeper  
Shown with five slotted light holes (VP142000-5S),  
6" wide also available
- 8 VP150109R** Rear tool box with locks, smooth stainless, rounded look
- 9 911** Turbowing for flat top / cabover
- 10 HV-XXXX-58-6BB-L01-UST** Front chrome bumper, boltless,  
22" American Eagle, 6 slotted light hole  
Multiple other stock & custom bumpers available

**SEE PAGES 138-161  
FOR MODEL 389  
ACCESSORIES**

# **PETERBILT MODEL 379**



**FOR 379 VISORS SEE PAGES 182-185**



# PETERBILT MODEL 379

## ONE-PIECE CAB/HOOD EXTENSION PANELS

MOUNTING HARDWARE INCLUDED

### VP116401

PB CAB & WIDE REPLACEMENT  
PANEL - ONE PIECE - 379 - 4" -  
BLANK



### VP116402

PB CAB & WIDE REPLACEMENT  
PANEL - ONE PIECE - WRAP - 379  
- 4" - BLANK

### VP116201

PB CAB & WIDE REPLACEMENT  
PANEL - ONE PIECE - 379 - 6" -  
BLANK



### VP116202

PB CAB & WIDE REPLACEMENT  
PANEL - ONE PIECE - WRAP - 379  
- 6" - BLANK

**BUILD A CUSTOM PANEL – SEE PAGES 92-93**





# PETERBILT MODEL 379



## CAB PANELS 4"

MOUNTING HARDWARE INCLUDED



**VP110203**

PB CAB PANELS - 1987 &  
NEWER - 379, 388, 389 -  
STANDARD - BLANK - PAIR



**VP110207**

PB CAB PANELS - 1987 &  
NEWER - 379, 388, 389 -  
EXTENDED - BLANK - PAIR



**VP110227**

PB CAB PANELS - 1987 &  
NEWER - 379, 388, 389 -  
STANDARD WRAP - BLANK - PAIR



**VP110228**

PB CAB PANELS - 1987 &  
NEWER - 379, 388, 389 -  
EXTENDED WRAP - BLANK - PAIR

BUILD A CUSTOM PANEL - SEE PAGES 92-93

## CAB PANELS 6"

MOUNTING HARDWARE INCLUDED



**VP110250**

PB CAB PANELS - 1987 &  
NEWER - 379, 388, 389 -  
STANDARD - BLANK - PAIR



**VP110251**

PB CAB PANELS - 1987 &  
NEWER - 379, 388, 389 -  
EXTENDED - BLANK - PAIR



**VP110254**

PB CAB PANELS - 1987 &  
NEWER - 379, 388, 389 -  
EXTENDED WRAP - BLANK - PAIR



**VP110253**

PB CAB PANELS - 1987 &  
NEWER - 379, 388, 389 -  
STANDARD WRAP - BLANK - PAIR

ADD LIGHT OPTIONS:



10"

EXAMPLE  
VP110207 - 4 UN



8"

EXAMPLE  
VP110207 - 5 RN



10"

EXAMPLE  
VP110203 - 4 RA



10"

EXAMPLE  
VP110203 - 4 GA

# **PETERBILT MODEL 379**

## **HOOD EXTENSION PANELS 4"**

MOUNTING HARDWARE INCLUDED (excl. VP110310)



**VP110300**  
PB 379 - HOOD EXTENSION  
PANEL - FACTORY  
REPLACEMENT



**VP110310**  
PB 379 - HOOD EXTENSION  
PANEL - FACTORY  
LAYOVER  
TAPE MOUNT



**VP110301**  
PB 379 - HOOD EXTENSION  
PANEL - WIDE REPLACEMENT  
- BLANK - PAIR

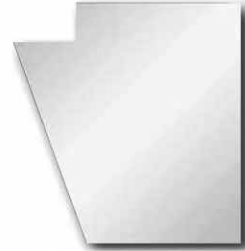

**VP110303**  
PB 379 - HOOD EXTENSION  
PANEL - WIDE REPLACEMENT  
NOTCHED - BLANK - PAIR

*BUILD A CUSTOM PANEL – SEE PAGES 92-93*

## **HOOD EXTENSION PANELS 6"**

MOUNTING HARDWARE INCLUDED



**VP110350**  
PB 379 - HOOD EXTENSION  
PANEL - FACTORY  
REPLACEMENT



**VP110352**  
PB 379 - HOOD EXTENSION  
PANEL - WIDE REPLACEMENT  
- BLANK - PAIR

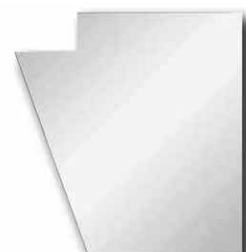

**VP110358**  
PB 379 - HOOD EXTENSION  
PANEL - WIDE REPLACEMENT  
NOTCHED - BLANK - PAIR

*ALL NOTCHED HOOD EXTENSION PANELS TAKE A STANDARD CAB PANEL  
ALL WIDE HOOD EXTENSION PANELS TAKE AN EXTENDED CAB PANEL*

# PETERBILT MODEL 379

## SLEEPER PANELS 4"

MOUNTING HARDWARE INCLUDED  
MATCH TO SLEEPER EXTENSION PANELS ON NEXT PAGE



**VP142004**

PB SLEEPER PANELS - 1987 & NEWER - 379, 388, 389 - 36"/44" - BLANK - PAIR



**VP142007**

PB SLEEPER PANELS - 1987 & NEWER - 379, 388, 389 - 48" - BLANK - PAIR



**VP142000**

PB SLEEPER PANELS - 1987 & NEWER - 379, 388, 389 - 63"/72" - BLANK - PAIR



**VP142002**

PB SLEEPER PANELS - 1987 & NEWER - 379, 388, 389 - 70"/80" - BLANK - PAIR

*ADD LIGHT OPTIONS*



**EXAMPLE**  
VP142002 - 8 RA



**EXAMPLE**  
VP142007 - 4 GA



*BUILD A CUSTOM PANEL - SEE PAGES 92-93*

## SLEEPER PANELS 6"

MOUNTING HARDWARE INCLUDED  
MATCH TO SLEEPER EXTENSION PANELS ON NEXT PAGE



**VP142050**

PB SLEEPER PANELS - 1987 & NEWER - 379, 388, 389 - 36"/44" - BLANK - PAIR



**VP142051**

PB SLEEPER PANELS - 1987 & NEWER - 379, 388, 389 - 48" - BLANK - PAIR



**VP142052**

PB SLEEPER PANELS - 1987 & NEWER - 379, 388, 389 - 63"/72" - BLANK - PAIR



**VP142053**

PB SLEEPER PANELS - 1987 & NEWER - 379, 388, 389 - 70"/80" - BLANK - PAIR

# PETERBILT MODEL 379

## SLEEPER EXTENSION PANELS 4"

MOUNTING HARDWARE INCLUDED

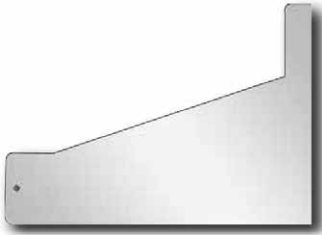

**VP142101**

PB SLEEPER EXTENSION  
PANEL - 1987 & NEWER - 379,  
388, 389 - 63"/72" - BLANK

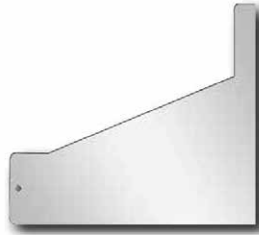

**VP142103**

PB SLEEPER EXTENSION  
PANEL - 1987 & NEWER - 379,  
388, 389 - 70"/80" - BLANK



BUILD A CUSTOM PANEL – SEE PAGES 92-93

## SLEEPER EXTENSION PANELS 6"

MOUNTING HARDWARE INCLUDED

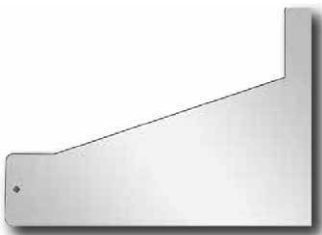

**VP142150**

PB SLEEPER EXTENSION  
PANEL - 1987 & NEWER - 379,  
388, 389 - 63"/72" - BLANK

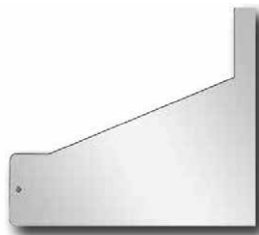

**VP142151**

PB SLEEPER EXTENSION  
PANEL - 1987 & NEWER - 379,  
388, 389 - 70"/80" - BLANK



# PETERBILT MODEL 379

## AIR CLEANER LIGHT BOXES VORTOX

CONNECT TO AIR CLEANER STRAPS:



**VP110109**  
PB - AIR CLEANER LIGHTS - BLANK - 377, 378, 379 - 1987 & NEWER - PAIR - VORTOX - FRONT



**VP113108**  
PB - AIR CLEANER LIGHTS - REAR - BLANK - 377, 378, 379 - 1987 & NEWER - PAIR - VORTOX - REAR

FOR STRAPLESS LOOK:



**VP112209**  
PB - AIR CLEANER SUPPORT - BLANK - 379, 388, 389 - 2007 & NEWER - PAIR

### BUILD A CUSTOM PANEL – SEE PAGES 92-93

EXAMPLE



**VP110109-8RA**  
PB - AIR CLEANER LIGHTS - 8 ROUND AMBERS - 377, 378, 379 - 1987 & NEWER - PAIR - VORTOX



*Don't Forget the Light Harness:*



**VHMS3007**  
1 - PACCAR - FEMALE 2 - PACCAR - MALE - FOR CONNECTING FRONT & REAR AIR CLEANER LIGHTS

# PETERBILT MODEL 379

## MIRROR LIGHT BOXES



**VP114011**  
MIRROR LIGHT BOXES - 379,  
388, 389 - CAB MOUNTED  
MIRRORS - BLANK



ADD -SM WITH BUILT IN SPOT MIRRORS

### BUILD A CUSTOM PANEL – SEE PAGES 92-93

#### EXAMPLES:



**VP114011-2GA**  
MIRROR LIGHT BOXES - 379,  
388, 389 - CAB MOUNTED  
MIRRORS - 2 - GRANITE -  
AMBER LEDS



**VP114011-5RCA**  
MIRROR LIGHT BOXES - 379,  
388, 389 - CAB MOUNTED  
MIRRORS - 5 - 2" ROUNDS -  
CLEAR AMBER LEDS



**VP114011-2SCA**  
MIRROR LIGHT BOXES - 379,  
388, 389 - CAB MOUNTED  
MIRRORS - 2 - SLOTTED - LEDS



**VP114011-5RA**  
MIRROR LIGHT BOXES - 379,  
388, 389 - CAB MOUNTED  
MIRRORS - 5 - 2" ROUNDS -  
AMBER LEDS

# PETERBILT MODEL 379

## BUMPER & GRILLE TRIM

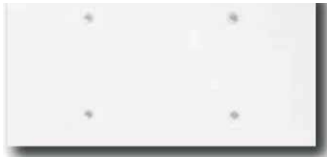

**VP120001**  
PB 1 TAG HANGER  
INCLUDES HARDWARE, FOAM  
PROTECTORS AND PLASTIC  
LICENSE PLATE BOLT INSERTS

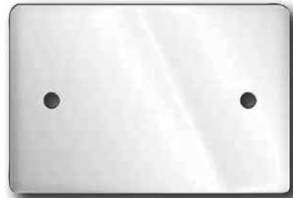

**VP120004**  
PB TOW PIN COVER - 378, 379 -  
1987 & NEWER  
MOUNTING HARDWARE  
INCLUDED

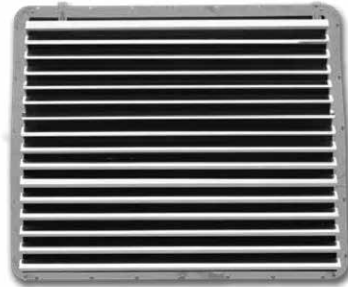

**VP120201**  
PB 379 LONG NOSE GRILL -  
HORIZONTAL - RIVETED  
MOUNTING HARDWARE  
INCLUDED



**VP120012**  
PB SIDE GRILL  
DEFLECTOR 379, 388, 389

SEE PAGE 82 FOR MORE TAG HANGERS

## FENDER GUARDS

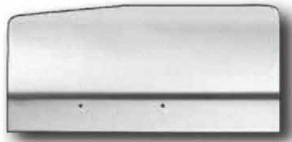

**VP120005**  
PB FENDER GUARDS - FITTED  
- 379 - 1987 & NEWER - 2PC

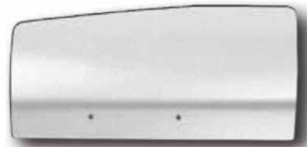

**VP120006**  
PB FENDER GUARDS -  
ROLLED, BOLT - THROUGH -  
379 - 1987 & NEWER - 2PC

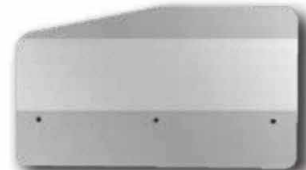

**VP120007**  
PB FENDER GUARDS - PLAIN -  
378, 379 - 1987 & NEWER



**VP120009**  
PB FENDER GUARDS -  
PLAIN - 378, 379 - 1987 &  
NEWER W/JJ CUTOUT

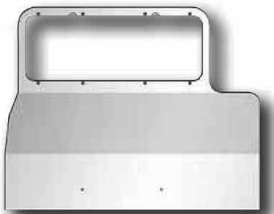

**VP120010**  
PB FENDER GUARDS - PB -  
HEAD LIGHT MOUNT - 378, 379  
- 1987 & NEWER - 2PC



**VP120011**  
PB FENDER GUARDS - SINGLE  
HEAD LIGHT MOUNT -  
378, 379 - 1987 & NEWER

# PETERBILT MODEL 379

## BUG SHIELDS

MOUNTING HARDWARE INCLUDED



**VP120100**  
PB BUG SHIELD - SHIELD ONLY - W/HOLES - 379 ONLY  
BLACK PLASTIC



**VP120101**  
PB BUG SHIELD - PLASTIC & HARDWARE - 379 ONLY  
BLACK PLASTIC



**VP120102**  
PB BUG SHIELD - W/TRIM & HARDWARE (HIGHLIGHT) - 379 ONLY  
BLACK PLASTIC WITH STAINLESS TRIM



**VP120103**  
PB BUG SHIELD TRIM ONLY (HIGHLIGHT) - 379 ONLY  
STAINLESS STEEL



**VP120104**  
PB BUG SHIELD - W/TRIM & HARDWARE (FLAMES) - 379 ONLY  
BLACK PLASTIC WITH STAINLESS TRIM



**VP120105**  
PB BUG SHIELD TRIM ONLY (FLAMES) - 379 ONLY  
STAINLESS STEEL



**VP120106**  
PB BUG SHIELD - STAINLESS - 379 - LONG HOOD



**VP120107**  
PB BUG SHIELD - STAINLESS - 357, 378, 385, 379 - SHORT HOOD





# PETERBILT MODEL 379

## BLINKER BARS

RUBBER TRIM AND MOUNTING HARDWARE INCLUDED



### VP120501

PB 379 FRONT BLINKER BARS  
- W/ LEDS - PAIR

NOTE: ALREADY HAS SLOTTED  
LIGHT HOLES AND LIGHTS, NO  
NEED TO BUILD CUSTOM

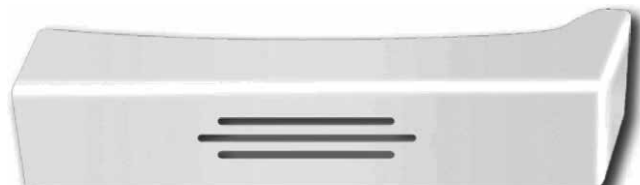

### VP100501

PB 379 REAR BLINKER BARS -  
- W/ LEDS - PAIR

NOTE: ALREADY HAS SLOTTED  
LIGHT HOLES AND LIGHTS, NO  
NEED TO BUILD CUSTOM



### VP120501BL

PB 379 FRONT BLINKER BARS

- W/ LEDS - PAIR

NO LIGHT HOLES

BUILD A CUSTOM ONE, SEE PAGE 92-93

## FENDER SUPPORT COVERS

RUBBER TRIM AND MOUNTING HARDWARE INCLUDED

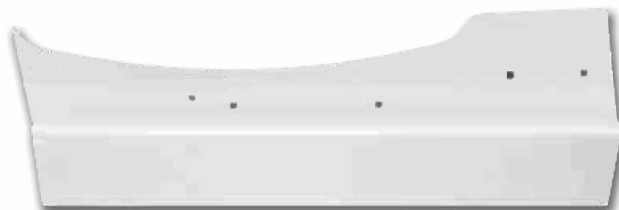

### VP120505

PB 379 FENDER SUPPORT  
COVER - FRONT - BLANK

# PETERBILT MODEL 379

## SLEEPER FILLER PANELS

MOUNTING HARDWARE INCLUDED



**VP140021**  
PB SLEEPER REAR CORNER  
FILLER PANELS 70" ONLY -  
379, 389 - 4 - 4" LEDES - PAIR

## SLEEPER SHOCK COVERS

RUBBER STRIP & HARDWARE INCLUDED



**VP140034**  
PB SLEEPER SHOCK COVERS  
- 379, 389 - 2 PCS (L+R)  
ANGLED  
TAPE MOUNT



**VP140022**  
PB 379, 389 SLEEPER SHOCK  
COVERS - 2 PAIR  
TAPE MOUNT

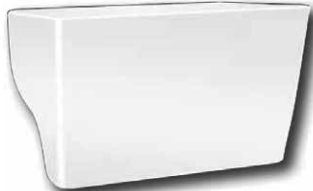

**VP140032**  
PB SLEEPER SHOCK COVERS  
- 379,389 - 1 LG FULL COVER  
TAPE MOUNT



**VP140035**  
PB SLEEPER SHOCK COVER -  
379,389 ANGLED FULL COVER



**VP140033**  
PB SLEEPER SHOCK COVERS  
- 379,389 - 1 LG CURVED FULL COVER

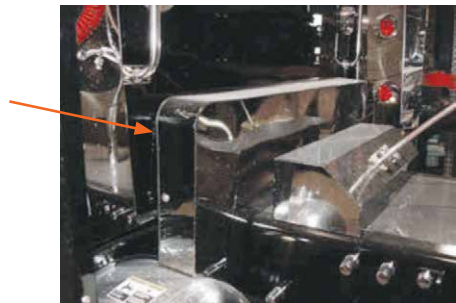
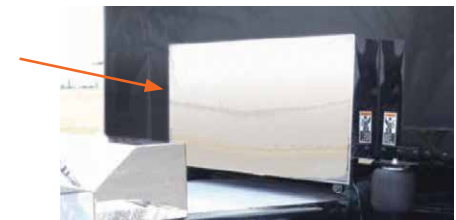
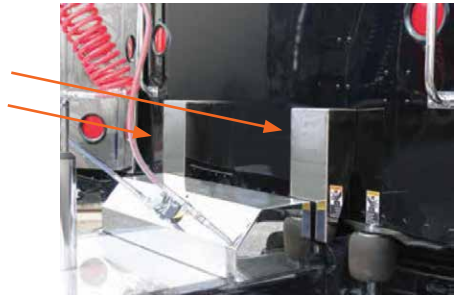

RUBBER STRIP & HARDWARE INCLUDED

# PETERBILT MODEL 379

## AIR DEFLECTORS

**VP110016**  
PB 359 - 379, 389 WINDOW AIR  
DEFLECTORS  
TAPE MOUNT



**VP110031**  
PB 359 - 379, 389 WINDOW  
AIR DEFLECTORS W/LOWER  
LOOKS( VP110017 )WINDOW  
TRIM 37.25" X 20.375"  
TAPE MOUNT



## FUEL TANK STRAP COVERS

BRACKETS & MOUNTING HARDWARE INCLUDED



**VP150020**  
PB - FUEL TANK STRAP  
COVERS - 4PCS



**VP150029**  
PB - FUEL TANK STRAP  
COVERS - 2PCS  
NOT 359















**VP150029R**  
PB - FUEL TANK STRAP  
COVERS - ROUND - 2PCS  
ALL BUT 359



**PETERBILT MODEL 379**

**FUEL TANK FAIRINGS**

BRACKETS & HARDWARE INCLUDED  
NOT AVAILABLE 430 STAINLESS

 <p>60"</p> <p><b>VP150010</b> PB - FUEL TANK FAIRINGS 60" 379 - 1987 &amp; NEWER - PAIR</p>	 <p>64"</p> <p><b>VP150011</b> PB - FUEL TANK FAIRINGS 64" 379 - 1987 &amp; NEWER - PAIR</p>	 <p>66"</p> <p><b>VP150012</b> PB - FUEL TANK FAIRINGS 66" 379 - 1987 &amp; NEWER - PAIR</p>	 <p><b>STANDARD</b></p>
 <p><b>VP150010R</b> PB - FUEL TANK FAIRINGS 60" 379 - 1987 &amp; NEWER - PAIR ROUND</p>	 <p><b>VP150011R</b> PB - FUEL TANK FAIRINGS 64" 379 - 1987 &amp; NEWER - PAIR ROUND</p>	 <p><b>VP150012R</b> PB - FUEL TANK FAIRINGS 66" 379 - 1987 &amp; NEWER - PAIR ROUND</p>	 <p><b>ROUNDED</b></p>
 <p><b>VP150010W</b> PB - FUEL TANK FAIRINGS 60" 379 - 1987 &amp; NEWER - PAIR - WING LOOK</p>	 <p><b>VP150011W</b> PB - FUEL TANK FAIRINGS 64" 379 - 1987 &amp; NEWER - PAIR - WING LOOK</p>	 <p><b>VP150012W</b> PB - FUEL TANK FAIRINGS 66" 379 - 1987 &amp; NEWER - PAIR - WING LOOK</p>	 <p><b>WING LOOK</b></p>

*BUILD A CUSTOM PANEL – SEE PAGES 92-93*

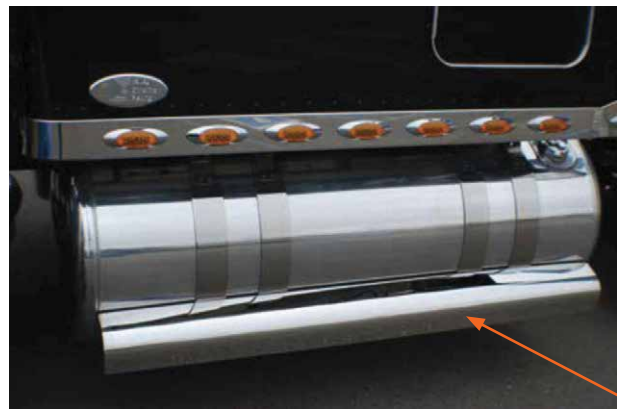

# PETERBILT MODEL 379

## EMBLEMS

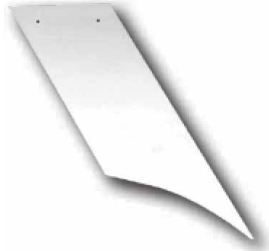

**VP100009**  
EMBLEM ACCENT PB 379  
RACING STRIPE - 2PC

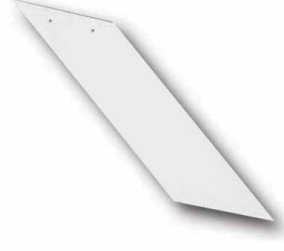

**VP100028**  
EMBLEM ACCENT PB 379 -  
RACING STRIPE - LONG - PAIR

## MISC. TRIM PIECES



**VP100021**  
PB 379 FENDER TRIM  
INNER WELL - 2PC

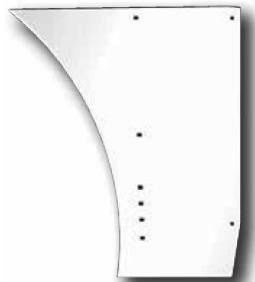

**VP100020**  
PB LOWER HOOD PANEL  
EXTENDED HOOD - 379 1987  
& NEWER - 2PC



**VP100025**  
PB 379 CENTER HOOD TRIM  
EXTENDED HOOD



**VP100026**  
PB 379 FENDER TRIM - 2PC

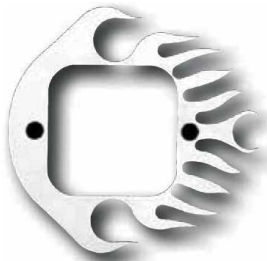

**VP110012**  
359, 379 DOOR FLAME  
TRIM - PAIR



**VP110018**  
PB WINDSHIELD TRIM - 5 PC  
379, 389 - LARGE



**VP110015**  
PB CENTER EXT WINDSHIELD  
TRIM - 377, 378, 379

# PETERBILT MODEL 379

## MISC TRIM PIECES



**VP110022**

PB 379 TOP OF DOOR TRIM - LOWERED LOOK - 73-04 - DOOR  
MOUNTED MIRRORS - PR  
TAPE MOUNT

**CUSTOM HEIGHTS AVAILABLE**



**VP110022P FOR PAINTABLE**



**VPTFI8021**

PB OUTER FENDER  
TRIM - 379

INCLUDES SET SCREWS  
SOLD AS SET OF 3 PAIR

**VPTFI8021S**

FOR ONE PAIR



**VP110025**

PB 379, 388, 389 WINDSHIELD WIPER  
ARM COVERS  
TAPE MOUNT





# PETERBILT MODEL 379

## BATTERY BOXES & TOOL BOXES

STANDARD WIDTH 30" / CUSTOM WIDTHS AVAILABLE UP TO 48"



VP150112 - PB - 379,388, 389 REAR TOOL BOX - STAINLESS W/LOCKS - MOULDED LID

VP150113 - PB - 379, 388, 389 BATTERY BOX - STAINLESS W/LOCKS - MOULDED LID

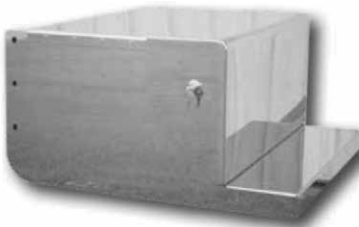

VP150109R - PB - 379, 388, 389 REAR TOOL BOX - STAINLESS W/LOCKS - ROUNDED SMOOTH LOOK

VP150110R - PB - 379, 388, 389 BATTERY BOX - STAINLESS W/LOCKS - ROUNDED SMOOTH LOOK



VP150115 - PB - 379,388, 389 REAR TOOL BOX - STAINLESS W/LOCKS - MOULDED LID

VP150116 - PB - 379, 388, 389 BATTERY BOX - STAINLESS W/LOCKS - MOULDED LID

VP150116TM - PB - 379, 388, 389 BATT. BOX - STAINLESS W/TIE DOWNS - 18" TALL MOLDED LID

ADD 36 TO ANY STAINLESS TOOL BOX PART NUMBER FOR A 36" BOX  
ADD -48 TO ANY STAINLESS TOOL BOX PART NUMBER FOR A 48" BOX



**VP150103**  
PB - 379, 388, 389 BATTERY BOX - ALUMINUM



**VP150104**  
PB - 379, 388, 389 BATTERY BOX - ALUMINUM



## BOX STEP HIGHLIGHTS/PROTECTORS



**VP150030**  
PB TOOL BOX/BATTERY BOX - STEP PROTECTOR-(18") - WICKED PR

**VP150031**  
PB TOOL BOX/BATTERY BOX - STEP PROTECTOR- (30") WICKED PAIR

PAINTED OPTIONS SHOWN





# **PETERBILT MODEL 379**

## **TOOL & BATTERY BOX COVERS**



**VP150002**  
PB TOOL & BATTERY BOX  
COVER 1993 & NEWER - 2 PC.



**VP150003**  
PB BATTERY BOX COVER 378,  
379 - 12" X 30" - 1993 & NEWER



**VP150004**  
PB TOOL BOX COVER 378, 379  
- 10" X 30" - 1993 & NEWER



**VP150015**  
PB TOOL BOX COVER -  
W/ 1" LIP ON TOP - 378, 379



**VP150016**  
PB 379 BATTERY BOX COVER -  
W/ 1" LIP ON TOP



**PETERBILT MODEL 384**



# PETERBILT MODEL 384

## CAB PANELS 4"

MOUNTING HARDWARE INCLUDED



**VP110338**

PB CAB PANELS - 384 - STANDARD -  
BLANK - WRAP PAIR

*BUILD A CUSTOM PANEL – SEE PAGES 92-93*

## CAB PANELS 6"

MOUNTING HARDWARE INCLUDED



**VP110252**

PB CAB PANELS - 384 -  
STANDARD - BLANK - PAIR



**VP110353**

PB CAB PANELS - 384 - STANDARD -  
BLANK - WRAP - PAIR

*ADD LIGHT OPTIONS:*



**EXAMPLE**  
VP110252 - 4 UN



**EXAMPLE**  
VP110252 - 5 RN



**EXAMPLE**  
VP110252 - 4 RA



**EXAMPLE**  
VP110252 - 3 GA

# PETERBILT MODEL 384

## SLEEPER PANELS 4"

MOUNTING HARDWARE INCLUDED  
MATCH TO SLEEPER EXTENSION PANELS ON NEXT PAGE



**VP142060**  
PB SLEEPER PANELS - 384  
- 36"/44" - NOTCHED FOR  
EXHAUST - BLANK



**VP142061**  
PB SLEEPER PANELS - 384 -  
48" - NOTCHED FOR EXHAUST  
- BLANK



**VP142062**  
PB SLEEPER PANELS - 384  
- 63"/72" - NOTCHED FOR  
EXHAUST - BLANK



**VP142063**  
PB SLEEPER PANELS - 384  
- 70"/80" - NOTCHED FOR  
EXHAUST - BLANK

*BUILD A CUSTOM PANEL – SEE PAGES 92-93*

## SLEEPER PANELS 6"

MOUNTING HARDWARE INCLUDED  
MATCH TO SLEEPER EXTENSION PANELS ON NEXT PAGE



**VP142160**  
PB SLEEPER PANELS - 384  
- 36"/44" - NOTCHED FOR  
EXHAUST - BLANK



**VP142161**  
PB SLEEPER PANELS - 384 -  
48" - NOTCHED FOR EXHAUST  
- BLANK



**VP142162**  
PB SLEEPER PANELS - 384  
- 63"/72" - NOTCHED FOR  
EXHAUST - BLANK



**VP142163**  
PB SLEEPER PANELS - 384  
- 70"/80" - NOTCHED FOR  
EXHAUST - BLANK

*ADD LIGHT OPTIONS*



**EXAMPLE**  
VP142063 – 8 RA



**EXAMPLE**  
VP142060 – 4 GA



# PETERBILT MODEL 384

## SLEEPER EXTENSION PANELS 4"

MOUNTING HARDWARE INCLUDED

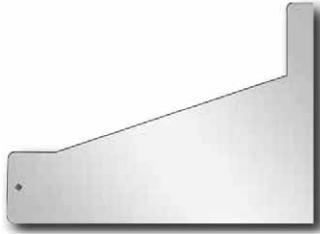

**VP142101**  
PB SLEEPER EXTENSION  
PANEL - 1987 & NEWER - 379,  
388, 389 - 63"/72" - BLANK

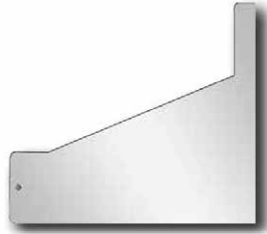

**VP142103**  
PB SLEEPER EXTENSION  
PANEL - 1987 & NEWER - 379,  
388, 389 - 70"/80" - BLANK



BUILD A CUSTOM PANEL – SEE PAGES 92-93

## SLEEPER EXTENSION PANELS 6"

MOUNTING HARDWARE INCLUDED

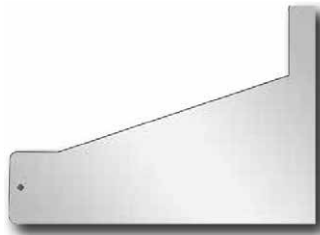

**VP142150**  
PB SLEEPER EXTENSION  
PANEL - 1987 & NEWER - 379,  
388, 389 - 63"/72" - BLANK

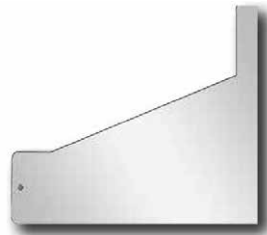

**VP142151**  
PB SLEEPER EXTENSION  
PANEL - 1987 & NEWER - 379,  
388, 389 - 70"/80" - BLANK



## BUG SHIELDS



**VP120111**  
PB BUG SHIELD - STAINLESS - 384  
MOUNTING HARDWARE INCLUDED



# **PETERBILT MODEL 386**



# PETERBILT MODEL 386

## CAB PANELS 2.5"

MOUNTING HARDWARE INCLUDED



**VP110200**  
PB CAB PANELS - 2005 &  
NEWER - 386 - BLANK

BUILD A CUSTOM PANEL – SEE PAGES 92-93

## EXHAUST FILLER PANEL 2.5"

MOUNTING HARDWARE INCLUDED



**VP110205**  
PB EX HAUST FILLER PANEL -  
386 - BLANK - PAIR

ADD LIGHT OPTIONS:



10" EXAMPLE  
VP110205 - 3 GA



13" EXAMPLE  
VP110205 - 3 PA



10" EXAMPLE  
VP110205 - 3 UN

386 PANELS ARE ONLY 2.5" WIDE AND CAN ONLY USE GRANITE, PETERBILT AND UNIVERSAL CUT OUTS.



# PETERBILT MODEL 386

## SLEEPER PANELS 2.5"

MOUNTING HARDWARE INCLUDED  
MATCH TO SLEEPER EXTENSION PANELS ON NEXT PAGE



**VP142008**

PB SLEEPER PANELS - 1987 &  
NEWER - 386 - 36"/44" -  
BLANK - PR



**VP142009**

PB SLEEPER PANELS - 1987 &  
NEWER - 386 - 48" -  
BLANK - PR



**VP142010**

PB SLEEPER PANELS - 1987 &  
NEWER - 386 - 63"/72"/72" -  
BLANK - PR



**VP142011**

PB SLEEPER PANELS - 1987 &  
NEWER - 386 - 70"/80" -  
BLANK - PR

*BUILD A CUSTOM PANEL – SEE PAGES 92-93*

*ADD LIGHT OPTIONS*



EXAMPLE  
VP142010 - 5 UN  
10"



EXAMPLE  
VP142011 - 6 PA  
10"



EXAMPLE  
VP142009 - 4 GA  
10"

386 PANELS ARE ONLY 2.5" WIDE AND CAN ONLY USE GRANITE, PETERBILT AND UNIVERSAL CUT OUTS.

# PETERBILT MODEL 386

## SLEEPER EXTENSION PANELS 2.5"

MOUNTING HARDWARE INCLUDED

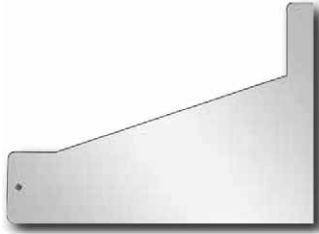

**VP142111**  
PB SLEEPER EXTENSION  
PANEL - 1987 & NEWER - 386 -  
2.5" WIDE - 70"/80" - BLANK

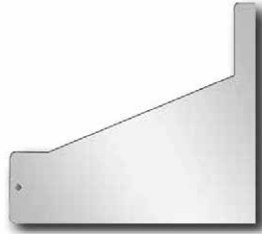

**VP142112**  
PB SLEEPER EXTENSION PANEL  
- 1987 & NEWER - 386 - 2.5" WIDE -  
36,48,63"/72" - BLANK

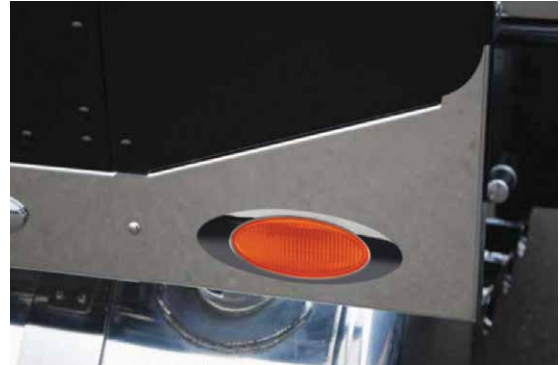

*BUILD A CUSTOM PANEL – SEE PAGES 92-93*

### ADD LIGHT OPTIONS

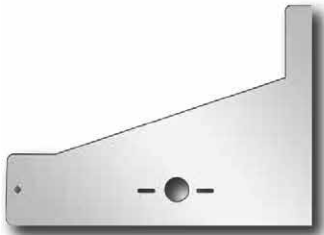

**EXAMPLE**  
VP142112-1UN



**EXAMPLE**  
VP142112-1GA



**EXAMPLE**  
VP142112-1PA

386 PANELS ARE ONLY 2.5" WIDE AND CAN ONLY USE GRANITE, PETERBILT AND UNIVERSAL CUT OUTS.

## BUG SHIELDS



**VP120112**  
PB BUG SHIELD - STAINLESS - 384  
MOUNTING HARDWARE INCLUDED

**PETERBILT MODELS 388 & 389**



*FOR 388 & 389 VISORS SEE PAGES 182-185*

# **PETERBILT MODELS 388 & 389**

## **FORMED CAB PANELS 4"**

MOUNTING HARDWARE INCLUDED

4" WIDE DRIVER SIDE, ALSO AVAILABLE IN 6" WIDTH  
2.25" ONLY ON PASSENGER SIDE



**VP114207**  
PB CAB PANELS - 1987 &  
NEWER - 388, 389 - FORMED  
EXTENDED - BLANK - PR



**VP114228**  
PB CAB PANELS - 1987 &  
NEWER - 388, 389 - FORMED  
EXTENDED WRAP- BLANK - PR



**VP114267**  
PB CAB PANELS - 389 - 2010 &  
NEWER - FORMED EXTENDED  
- W / UREA SYSTEM - 2.1/4"  
PASSANGER SIDE - 4" DRIVERS  
SIDE - BLANK

*BUILD A CUSTOM PANEL – SEE PAGES 92-93*

## **FORMED CAB PANELS 6"**



**VP114251**  
PB CAB PANELS - 1987 &  
NEWER - 388, 389 - FORMED  
EXTENDED - BLANK - PR



**VP114253**  
PB CAB PANELS - 1987 &  
NEWER - 388, 389 - FORMED  
EXTENDED WRAP- BLANK - PR

*ADD LIGHT OPTIONS:*



**EXAMPLE**  
VP114251-3GA





# PETERBILT MODELS 388 & 389

## ONE-PIECE CAB/HOOD EXTENSION PANELS, NO DEF SYSTEM

MOUNTING HARDWARE INCLUDED

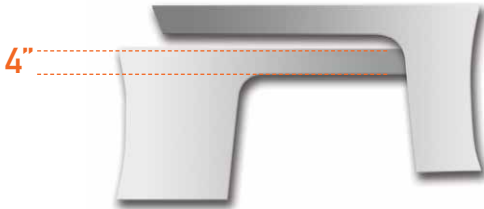

4"

**VP116400**

PB CAB & WIDE REPLACEMENT PANEL - ONE PIECE - 389 2009-2011 - NON UREA - WIDE REPLACEMENT DRIVERS SIDE - SMALL REPLACEMENT PASSENGERS SIDE - 4" CAB PANELS - BLANK

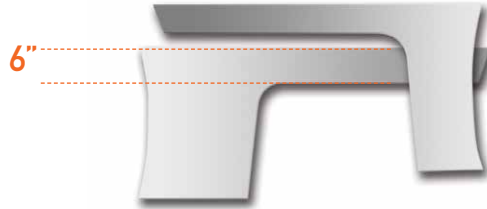

6"

**VP116200**

PB CAB & WIDE REPLACEMENT PANEL - ONE PIECE - 389 2009-2011 - NON UREA - WIDE REPLACEMENT DRIVERS SIDE - SMALL REPLACEMENT PASSENGERS SIDE - 6" CAB PANELS - BLANK

**VP116411**

PB CAB & WIDE REPLACEMENT PANEL - ONE PIECE - 389 2009-2011 - NON UREA - WIDE REPLACEMENT DRIVERS SIDE - SMALL REPLACEMENT PASSENGERS SIDE - 4" CAB PANELS - WRAP - BLANK

**VP116211**

PB CAB & WIDE REPLACEMENT PANEL - ONE PIECE - 389 2009-2011 - NON UREA - WIDE REPLACEMENT DRIVERS SIDE - SMALL REPLACEMENT PASSENGERS SIDE - 6" CAB PANELS - WRAP - BLANK

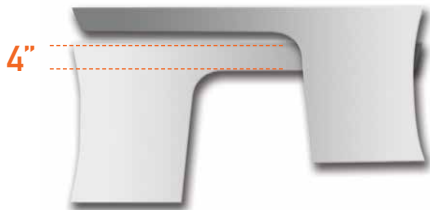

4"

**VP116420**

PB CAB & WIDE REPLACEMENT PANEL BOTH SIDES - ONE PIECE - 389 2008 - NON UREA - 4" CAB PANELS - BLANK

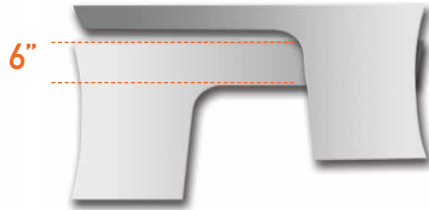

6"

**VP116420-6**

PB CAB & WIDE REPLACEMENT PANEL BOTH SIDES - ONE PIECE - 389 2008 - NON UREA - 6" CAB PANELS - BLANK

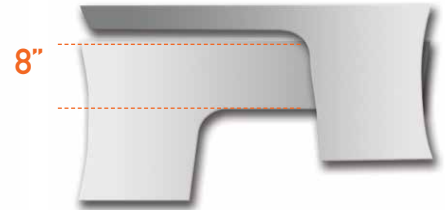

8"

**VP116420-8**

PB CAB & WIDE REPLACEMENT PANEL BOTH SIDES - ONE PIECE - 389 2008 - NON UREA - 8" CAB PANELS - BLANK

2008-2010 WITH CAT ENGINES USE WIDE PANELS BOTH SIDES  
2009-2010 CUMMINS ENGINES USE WIDE DRIVER SIDE, NARROW PASSENGER

BUILD A CUSTOM PANEL – SEE PAGES 92-93



VP116411-8GA shown

**PETERBILT MODELS 388 & 389**

**ONE-PIECE CAB/HOOD EXTENSION PANELS DEF SYSTEM**

MOUNTING HARDWARE INCLUDED

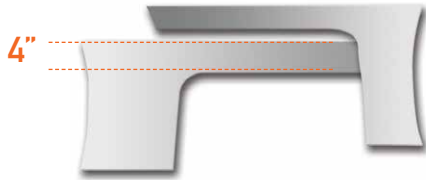

**VP116421**

PB CAB & WIDE REPLACEMENT PANEL - ONE PIECE - 389 - 2010 & NEWER W/UREA SYSTEM - WIDE REPLACEMENT DRIVERS SIDE - SMALL REPLACEMENT PASSENGERS SIDE - 2.1/4" CAB PANEL DRIVERS SIDE - 4" CAB PANEL PASSENGERS SIDE - BLANK

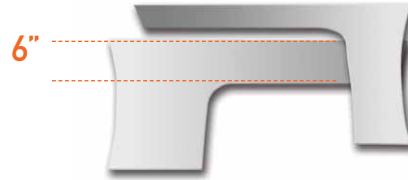

**VP116425**

PB CAB & WIDE REPLACEMENT PANEL - ONE PIECE - 389 - 2010 & NEWER W/ UREA SYSTEM - WIDE REPLACEMENT DRIVERS SIDE - SMALL REPLACEMENT PASSENGERS SIDE - 2.1/4" CAB PANEL DRIVERS SIDE - 6" CAB PANEL PASSENGERS SIDE - BLANK

2008-2010 WITH CAT ENGINES USE WIDE PANELS BOTH SIDES  
2009-2010 CUMMINS ENGINES USE WIDE DRIVER SIDE, NARROW PASSENGER

*BUILD A CUSTOM PANEL – SEE PAGES 92-93*

**ONE-PIECE CAB/HOOD EXTENSION PANELS, NO DEF SYSTEM**

FORMED PANELS • HARDWARE INCLUDED

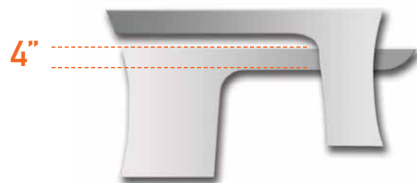

**VP114400**

PB CAB & WIDE REPLACEMENT PANEL - FORMED ONE PIECE - 389 2009-2011 - NON UREA - WIDE REPLACEMENT DRIVERS SIDE - SMALL REPLACEMENT PASSENGERS SIDE - 4" CAB PANELS - BLANK



**VP114411**

PB CAB & WIDE REPLACEMENT PANEL - FORMED ONE PIECE - 389 2009-2011 - NON UREA - WIDE REPLACEMENT DRIVERS SIDE - SMALL REPLACEMENT PASSENGERS SIDE - 4" CAB PANELS - WRAP - BLANK

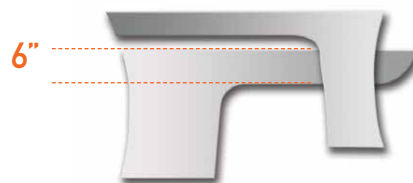

**VP114200**

PB CAB & WIDE REPLACEMENT PANEL - FORMED ONE PIECE - 389 2009-2011 - NON UREA - WIDE REPLACEMENT DRIVERS SIDE - SMALL REPLACEMENT PASSENGERS SIDE - 6" CAB PANELS - BLANK

**VP114211**

PB CAB & WIDE REPLACEMENT PANEL - FORMED ONE PIECE - 389 2009-2011 - NON UREA - WIDE REPLACEMENT DRIVERS SIDE - SMALL REPLACEMENT PASSENGERS SIDE - 6" CAB PANELS - WRAP - BLANK

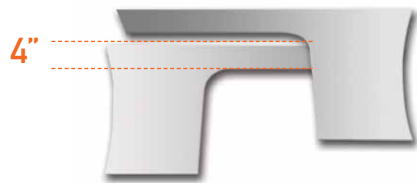

**VP114420**

PB CAB & WIDE REPLACEMENT PANEL BOTH SIDES - FORMED ONE PIECE - 389 2008 - NON UREA - 4" CAB PANELS - BLANK

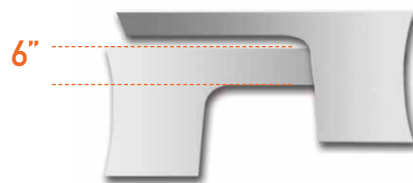

**VP114420-6**

PB CAB & WIDE REPLACEMENT PANEL BOTH SIDES - FORMED ONE PIECE - 389 2008 - NON UREA - 6" CAB PANELS - BLANK

# PETERBILT MODELS 388 & 389

## ONE-PIECE CAB/HOOD EXTENSION PANELS DEF SYSTEM

FORMED PANELS • HARDWARE INCLUDED

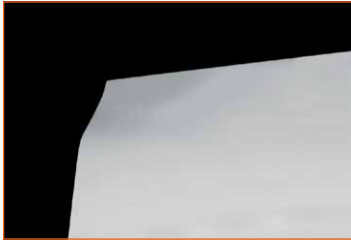

CORNER FOLLOWS  
CONTOUR OF TRUCK



**VP114421**

PB CAB & WIDE REPLACEMENT PANEL - FORMED ONE PIECE - 389 - 2010 & NEWER W/ UREA SYSTEM - WIDE REPLACEMENT DRIVERS SIDE - SMALL REPLACEMENT PASSENGERS SIDE - 2.1/4" CAB PANEL DRIVERS SIDE - 4" CAB PANEL PASSENGERS SIDE - BLANK

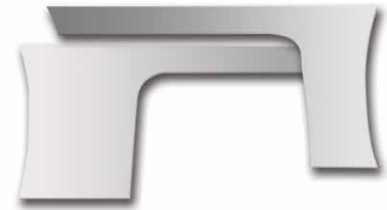

**VP114422**

PB CAB & WIDE REPLACEMENT PANEL - FORMED - ONE PIECE - 388, 389 - 2010 & NEWER W/ UREA SYSTEM - WIDE REPLACEMENT DRIVERS SIDE - SMALL REPLACEMENT PASSENGERS SIDE - 4" CAB PANEL DRIVERS SIDE - 2.1/4" CAB PANEL PASSENGERS SIDE - WRAPPED - BLANK

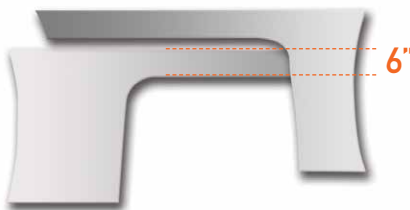

**VP114425**

PB CAB & WIDE REPLACEMENT PANEL - FORMED ONE PIECE - 389 - 2010 & NEWER W/ UREA SYSTEM - WIDE REPLACEMENT DRIVERS SIDE - SMALL REPLACEMENT PASSENGERS SIDE - 2.1/4" CAB PANEL DRIVERS SIDE - 6" CAB PANEL PASSENGERS SIDE - BLANK



**VP114426**

PB CAB & WIDE REPLACEMENT PANEL - FORMED - ONE PIECE - 388, 389 - 2014 & NEWER W/ UREA SYSTEM AND DYNAFLEX KIT - WIDE REPLACEMENT DRIVERS SIDE - SMALL REPLACEMENT PASSENGERS SIDE - 4" CAB PANEL DRIVERS SIDE - 2.1/4" CAB PANEL PASSENGERS SIDE - BLANK

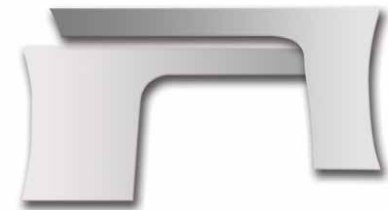

**VP114427**

PB CAB & WIDE REPLACEMENT PANEL - FORMED - ONE PIECE - 388, 389 - 2014 & NEWER W/ UREA SYSTEM AND DYNAFLEX KIT - WIDE REPLACEMENT DRIVERS SIDE - SMALL REPLACEMENT PASSENGERS SIDE - 4" CAB PANEL DRIVERS SIDE - 2.1/4" CAB PANEL PASSENGERS SIDE - WRAPPED - BLANK

2008-2010 WITH CAT ENGINES USE WIDE PANELS BOTH SIDES  
2009-2010 CUMMINS ENGINES USE WIDE DRIVER SIDE, NARROW PASSENGER





**BUILD A CUSTOM PANEL - SEE PAGES 92-93**



# PETERBILT MODELS 388 & 389





## CAB PANELS 4"

MOUNTING HARDWARE INCLUDED

- |  |  |  |   |
|--|--|--|---|
| <br><b>VP110203</b><br>PB CAB PANELS - 1987 &<br>NEWER - 379, 388, 389 -<br>STANDARD - BLANK - PAIR | <br><b>VP110207</b><br>PB CAB PANELS - 1987 &<br>NEWER - 379, 388, 389 -<br>EXTENDED - BLANK - PAIR | <br><b>VP110227</b><br>PB CAB PANELS - 1987 &<br>NEWER - 379, 388, 389 -<br>STANDARD WRAP - BLANK - PAIR | <br><b>VP110228</b><br>PB CAB PANELS - 1987 &<br>NEWER - 379, 388, 389 -<br>EXTENDED WRAP - BLANK - PAIR |
|--|--|--|---|

## CAB PANELS 6"

MOUNTING HARDWARE INCLUDED

- |  |  |  |   |
|--|--|--|---|
| <br><b>VP110250</b><br>PB CAB PANELS - 1987 &<br>NEWER - 379, 388, 389 -<br>STANDARD - BLANK - PAIR | <br><b>VP110251</b><br>PB CAB PANELS - 1987 &<br>NEWER - 379, 388, 389 -<br>EXTENDED - BLANK - PAIR | <br><b>VP110254</b><br>PB CAB PANELS - 1987 &<br>NEWER - 379, 388, 389 -<br>STANDARD WRAP - BLANK - PAIR | <br><b>VP110253</b><br>PB CAB PANELS - 1987 &<br>NEWER - 379, 388, 389 -<br>STANDARD WRAP - BLANK - PAIR |
|--|--|--|---|

*BUILD A CUSTOM PANEL – SEE PAGES 92-93*

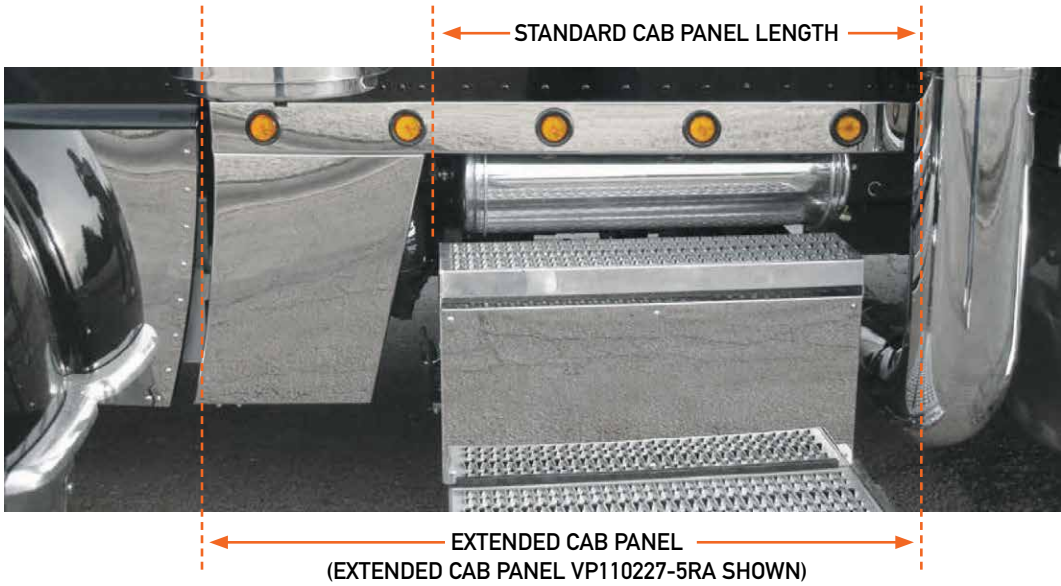

# **PETERBILT MODELS 388 & 389**

## **CAB PANELS NO DEF SYSTEM**

*MOUNTING HARDWARE INCLUDED*



### **VP113890**

PB CAB PANELS - 1987 &  
NEWER - 389 - STANDARD -  
BLANK - PR - 44.38" LONG



### **VP113891**

PB CAB PANELS - 1987 &  
NEWER - 389 - STANDARD  
WRAP - BLANK - PR

## **CAB PANELS DEF SYSTEM**

*MOUNTING HARDWARE INCLUDED*



### **VP110263**

PB CAB PANELS - 388,389 - 2010  
& NEWER - STANDARD - W / UREA  
SYSTEM - 2.1/4" PASSENGER SIDE  
- 4" DRIVERS SIDE - BLANK



### **VP110264**

PB CAB PANELS - 388,389  
- 2010 & NEWER - WRAP -  
W / UREA SYSTEM - 2.1/4"  
PASSENGER SIDE - 4"  
DRIVERS SIDE - BLANK



### **VP110267**

PB CAB PANELS - 389 - 2010 &  
NEWER - EXTENDED - W / UREA  
SYSTEM - 2.1/4" PASSENGER  
SIDE - 4" DRIVERS SIDE - BLANK

*4" WIDE DRIVER SIDE, ALSO AVAILABLE IN 6" WIDTH  
2.25" ONLY ON PASSENGER SIDE*

*BUILD A CUSTOM PANEL – SEE PAGES 92-93*

# PETERBILT MODELS 388 & 389

## SLEEPER PANELS 4"

MOUNTING HARDWARE INCLUDED  
MATCH TO SLEEPER EXTENSION PANELS ON PAGE 149



**VP142004**

PB SLEEPER PANELS - 1987 & NEWER - 379, 388, 389 - 36"/44" - BLANK - PAIR



**VP142007**

PB SLEEPER PANELS - 1987 & NEWER - 379, 388, 389 - 48" - BLANK - PAIR



**VP142000**

PB SLEEPER PANELS - 1987 & NEWER - 379, 388, 389 - 63"/72" - BLANK - PAIR



**VP142002**

PB SLEEPER PANELS - 1987 & NEWER - 379, 388, 389 - 70"/80" - BLANK - PAIR

*BUILD A CUSTOM PANEL - SEE PAGES 92-93*

## SLEEPER PANELS 6"

MOUNTING HARDWARE INCLUDED



**VP142050**

PB SLEEPER PANELS - 1987 & NEWER - 379, 388, 389 - 36"/44" - BLANK - PAIR



**VP142051**

PB SLEEPER PANELS - 1987 & NEWER - 379, 388, 389 - 48" - BLANK - PAIR



**VP142052**

PB SLEEPER PANELS - 1987 & NEWER - 379, 388, 389 - 63"/72" - BLANK - PAIR



**VP142053**

PB SLEEPER PANELS - 1987 & NEWER - 379, 388, 389 - 70"/80" - BLANK - PAIR

*ADD LIGHT OPTIONS*



**EXAMPLE**  
VP142002 - 8 RA



**EXAMPLE**  
VP142007 - 4 GA



# **PETERBILT MODELS 388 & 389**

## **HOOD EXTENSION PANELS 4"**

*MOUNTING HARDWARE INCLUDED (EXCEPT VP110314 TAPE MOUNT)*



**VP110313**

PB 389 - HOOD EXTENSION  
PANEL - FACTORY  
REPLACEMENT - PAIR



**VP110314**

PB 389 - HOOD EXTENSION  
PANEL - FACTORY LAYOVER  
- PAIR, TAPE MOUNT

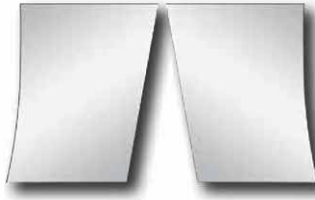

**VP110308**

PB 389 - HOOD EXTENSION  
PANEL - WIDE REPLACEMENT  
- BLANK - PAIR



**VP110309**

PB 389 - HOOD EXTENSION  
PANEL - WIDE REPLACEMENT  
NOTCHED - BLANK - PAIR

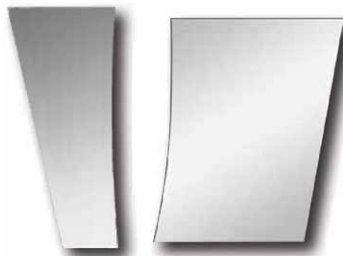

**VP110311**

PB 389 - HOOD EXTENSION  
PANEL - WIDE REPLACEMENT  
- BLANK - W/DEF - PAIR



**VP110312**

PB 389 - HOOD EXTENSION PANEL  
- WIDE REPLACEMENT NOTCHED -  
BLANK - W/DEF - PAIR

## **HOOD EXTENSION PANELS 6"**

*MOUNTING HARDWARE INCLUDED*



**VP110364**

PB 389 - HOOD EXTENSION  
PANEL - FACTORY  
REPLACEMENT - PAIR

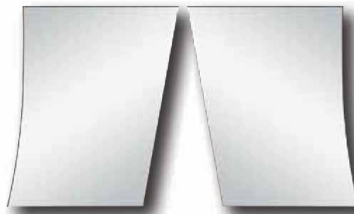

**VP110366**

PB 389 - HOOD EXTENSION  
PANEL - WIDE REPLACEMENT  
- BLANK - PAIR



**VP110367**

PB 389 - HOOD EXTENSION  
PANEL - WIDE REPLACEMENT  
NOTCHED - BLANK - PAIR

# PETERBILT MODELS 388 & 389

## HOOD EXTENSION PANELS 4"

MOUNTING HARDWARE INCLUDED

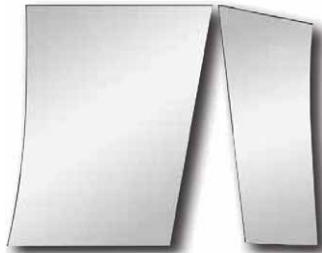

**VP110307**

PB 389 - HOOD EXTENSION  
PANEL - WIDE REPLACEMENT  
- BLANK - W/PICKETT  
EXHAUST ELBOWS - PAIR

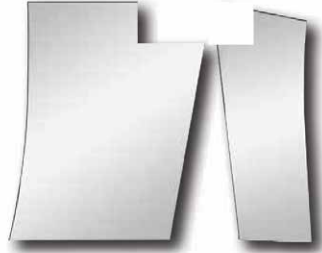

**VP110397**

PB 389 - HOOD EXTENSION  
PANEL - WIDE REPLACEMENT  
- NOTCHED- BLANK - W/  
PICKETT EXHAUST ELBOWS - PAIR

## HOOD EXTENSION PANELS 6"

MOUNTING HARDWARE INCLUDED

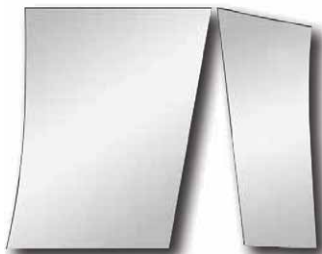

**VP110379**

PB 389 - HOOD EXTENSION  
PANEL - WIDE REPLACEMENT  
- BLANK - W/PICKETT  
EXHAUST ELBOWS - PAIR

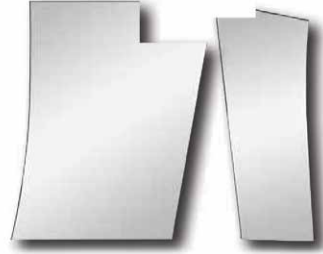

**VP110398**

PB 389 - HOOD EXTENSION  
PANEL - WIDE REPLACEMENT  
- NOTCHED- BLANK - W/  
PICKETT EXHAUST ELBOWS - PAIR

*ADD LIGHT OPTIONS*

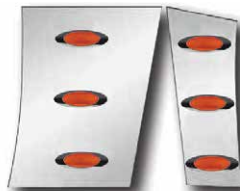

**EXAMPLE**  
VP110307-3GA

*BUILD A CUSTOM PANEL – SEE PAGES 92-93*

# **PETERBILT MODELS 388 & 389**

## **388 CAB PANEL DEF SYSTEM**

*MOUNTING HARDWARE INCLUDED*

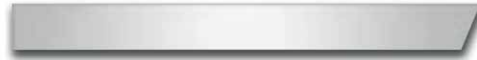

**VP110229**

2012 AND NEWER 388 W/DEF  
WITH VERTICAL EXHAUST  
PASSENGER SIDE 35", DRIVER SIDE 40"

*BUILD A CUSTOM PANEL – SEE PAGES 92-93*



*Also check out our model 388 & 389  
bumpers, page 54*



# PETERBILT MODELS 388 & 389

## SLEEPER EXTENSION PANELS 4"

MOUNTING HARDWARE INCLUDED

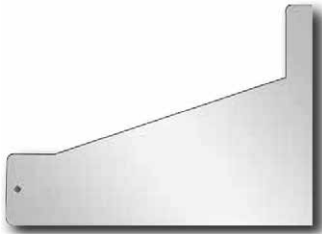

**VP142101**

PB SLEEPER EXTENSION  
PANEL - 1987 & NEWER - 379,  
388, 389 - 63"/72" - BLANK

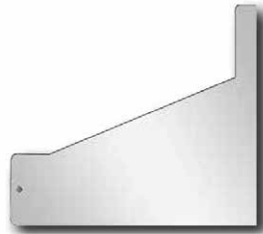

**VP142103**

PB SLEEPER EXTENSION  
PANEL - 1987 & NEWER - 379,  
388, 389 - 70"/80" - BLANK



## SLEEPER EXTENSION PANELS 6"

MOUNTING HARDWARE INCLUDED

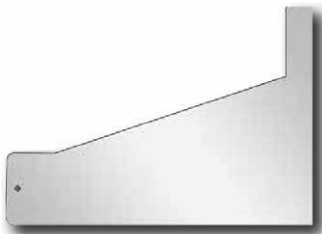

**VP142150**

PB SLEEPER EXTENSION  
PANEL - 1987 & NEWER - 379,  
388, 389 - 63"/72" - BLANK

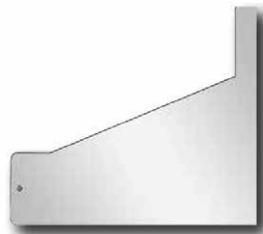

**VP142151**

PB SLEEPER EXTENSION  
PANEL - 1987 & NEWER - 379,  
388, 389 - 70"/80" - BLANK



VP142151-1GA SHOWN

### BUILD A CUSTOM PANEL – SEE PAGES 92-93

**EXAMPLE**  
VP142101-1GA





# PETERBILT MODELS 388 & 389

## AIR CLEANER LIGHT BOXES DONALDSON

CONNECT TO AIR CLEANER STRAPS:



**VP112109**

PB - AIR CLEANER LIGHTS - BLANK  
- 388, 389 - 2007 & NEWER - PR -  
DONALDSON/PREMIUM - FRONT



**VP113109**

PB - AIR CLEANER LIGHTS - BLANK -  
REAR - 388, 389 - 2007 & NEWER - PR -  
DONALDSON/PREMIUM - REAR

FOR STRAPLESS LOOK:



**VP112209**

PB - AIR CLEANER SUPPORT - BLANK -  
379, 388, 389 - 2007 & NEWER - PAIR

### BUILD A CUSTOM PANEL – SEE PAGES 92-93



**VP112109-7RA**

PB - AIR CLEANER LIGHTS - 8 ROUND  
AMBERS - 388, 389 - 2007 & NEWER - PAIR -  
DONALDSON/PREMIUM

*Don't Forget the  
Light Harness:*



**VHMS3007**

1 - PACCAR - FEMALE 2 - PACCAR - MALE  
- FOR CONNECTING FRONT & REAR AIR  
CLEANER LIGHTS

# **PETERBILT MODELS 388 & 389**

## **MIRROR LIGHT BOXES**



**VP114011**  
MIRROR LIGHT BOXES - 379.  
388, 389 - CAB MOUNTED  
MIRRORS - BLANK



ADD -SM WITH BUILT IN SPOT MIRRORS

*BUILD A CUSTOM PANEL – SEE PAGES 92-93*

### **EXAMPLES:**



**VP114011-2GA**  
MIRROR LIGHT BOXES - 379.  
388, 389 - CAB MOUNTED  
MIRRORS - 2 - GRANITE -  
AMBER LEDS



**VP114011-5RCA**  
MIRROR LIGHT BOXES - 379.  
388, 389 - CAB MOUNTED  
MIRRORS - 5 - 2" ROUNDS -  
CLEAR AMBER LEDS



**VP114011-2SCA**  
MIRROR LIGHT BOXES - 379.  
388, 389 - CAB MOUNTED  
MIRRORS - 2 - SLOTTED - LEDS



**VP114011-5RA**  
MIRROR LIGHT BOXES - 379.  
388, 389 - CAB MOUNTED  
MIRRORS - 5 - 2" ROUNDS -  
AMBER LEDS

# **PETERBILT MODELS 388 & 389**

## **BUMPER & GRILLE TRIM**



**VP120000**  
PB TAG HANGER  
(388, 389)  
INCLUDES HARDWARE, FOAM  
PROTECTORS AND PLASTIC  
LICENSE PLATE BOLT INSERTS

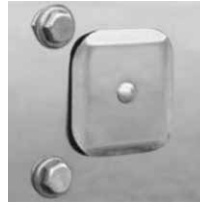

**VK120003**  
TOW PIN COVER FITS 389



**VP120012**  
PB SIDE GRILL  
DEFLECTOR 379, 388, 389

SEE PAGE 82 FOR MORE TAG HANGERS

## **FENDER GUARDS**

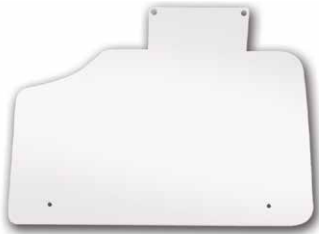

**VP120013**  
PB FENDER GUARDS -  
HEAD LIGHT MOUNT - 388,  
389 - 2007 & NEWER



**VP120014**  
PB FENDER GUARDS - PB -  
HEAD LIGHT MOUNT  
- 389 - W/BLINKER BAR - PR

## **BUG SHIELDS**



**VP120110**  
PB BUG SHIELD - STAINLESS  
- 367, 388, 389  
MOUNTING HARDWARE INCLUDED



# PETERBILT MODELS 388 & 389

## EMBLEMS



**VP100032**  
PB 389 EMBLEM ACCENT -  
RACING STRIPE -  
LONG HOOD  
INCLUDES MOUNTING HARDWARE



**VP100033**  
PB 389 EMBLEM ACCENT -  
RACING STRIPE  
- SHORT HOOD  
TAPE MOUNT



**VP100040**  
PB 389 HOOD LATCH  
GUARD - PAIR  
INCLUDES MOUNTING  
HARDWARE

## FENDER TRIM



**VP100123**  
PB 389 FENDER  
TRIM - INNER WELL - 2PC  
TAPE MOUNT



**VP100122**  
PB389 FENDER TRIM - 2PC  
TAPE MOUNT

## HOOD TRIM

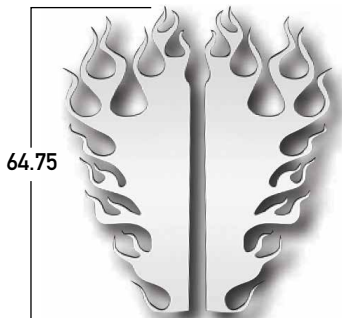

64.75

**VP100124**  
PB 389 CENTER HOOD TRIM  
2PC FLAME



**VP100121**  
PB CENTER HOOD TRIM - 389  
SCREW ON

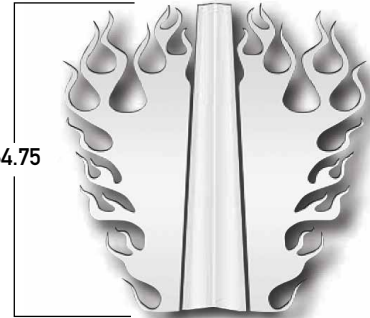

64.75

**VP100125**  
PB 389 CENTER HOOD TRIM  
3PC FLAME (VP100121,  
VP100124)

# **PETERBILT MODELS 388 & 389**

## **BLINKER BARS**

*RUBBER TRIM AND MOUNTING HARDWARE INCLUDED*



**VP120502**  
PB 389 FRONT BLINKER BARS  
- W/LEDS - PAIR  
NOTE: ALREADY HAS SLOTTED  
LIGHT HOLES AND LIGHTS, NO  
NEED TO BUILD AS CUSTOM



**VP100502**  
PB 389 REAR BLINKER BARS -  
- W/LEDS - PAIR  
NOTE: ALREADY HAS SLOTTED  
LIGHT HOLES AND LIGHTS, NO  
NEED TO BUILD AS CUSTOM

## **FENDER SUPPORT COVERS**

*RUBBER TRIM AND MOUNTING HARDWARE INCLUDED*



**VP120503**  
PB 389 FENDER SUPPORT  
COVER - FRONT  
TOO NARROW FOR LIGHT OPTIONS



**VP100503**  
PB 389 FENDER SUPPORT  
COVER - REAR  
TOO NARROW FOR LIGHT OPTIONS

**VP120502**

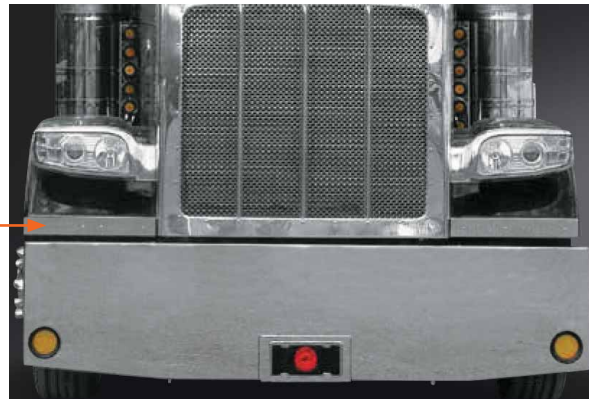

# **PETERBILT MODELS 388 & 389**

## **STAINLESS VISORS**



### **VP130013**

PB - 389 14" - DROP VISOR - 2007 - NEWER STANDARD W/ CAB MTD. MIRRORS CURVED WINDOW, ONE PIECE WINDSHIELD ALSO FITS MODEL 348

**PAINTABLE  
VISORS  
AVAILABLE**

JUST ADD "P" TO THE END FOR PAINTABLE. EXAMPLE:

**VP130013-P**  
RAW 18 GAUGE STEEL

*BUILD A CUSTOM VISOR –  
SEE PAGES 92-93 FOR LIGHT OPTIONS*

*FOR MORE PETE VISORS SEE PAGES 182-185*

## **SLEEPER FILLER PANELS**

*MOUNTING HARDWARE INCLUDED*



### **VP140021**

PB SLEEPER REAR CORNER FILLER PANELS 70" ONLY - 379, 389 - 4 - 4" LEDS - PAIR

# PETERBILT MODELS 388 & 389

## MISC. TRIM PIECES



**VP101001**  
PB 389 LOWER HOOD PANEL -  
2007 & NEWER - PAIR



**VP100038**  
PB - 389 FRONT FLAP  
WEIGHTS - 11GA - PAIR



**VP110018**  
PB WINDSHIELD TRIM - 5 PC  
379, 389 - LARGE



**VPTFI8022**  
PB OUTER FENDER  
TRIM - 389  
DOES NOT FIT 388  
SOLD AS A SET OF 3 PAIR

**VPTFI8022S**  
FOR ONE PAIR



5"

**VP110017**  
PB 388/389 TOP OF DOOR TRIM - LOWERED LOOK - PAIR  
WILL ONLY FIT DOORS WITHOUT VENT WINDOW

**VP110017P**



ADD -P FOR PAINTABLE



# PETERBILT MODELS 388 & 389

## MISC. TRIM PIECES



**VP110020**  
PB - OUTSIDE DOOR TRIM -  
389 - 2-PCS  
TAPE MOUNT



**VP110025**  
PB 379, 388, 389 WINDSHIELD WIPER  
ARM COVERS  
TAPE MOUNT



**VP110019**  
PB 389 OUTSIDE DOOR TRIM -  
CORNER ANGLE - PAIR  
TAPE MOUNT



**VP110090**  
PB EXHAUST SHIELDS -  
388, 389 - W/NO LOGO  
BRACKETS & HARDWARE INCLUDED

# PETERBILT MODELS 388 & 389

## SLEEPER SHOCK COVERS



**VP140034**  
PB SLEEPER SHOCK COVERS  
- 379, 389 - 2 PCS (L+R)  
ANGLED  
TAPE MOUNT



**VP140022**  
PB 379, 389 SLEEPER SHOCK  
COVERS - 2 PAIR  
TAPE MOUNT

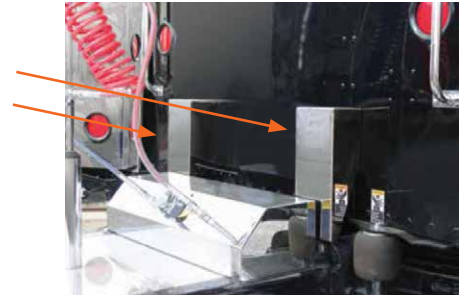

**VP140032**  
PB SLEEPER SHOCK COVERS  
- 379,389 - 1 LG FULL COVER  
TAPE MOUNT



**VP140035**  
PB SLEEPER SHOCK COVER -  
379,389 ANGLED FULL COVER



**VP140033**  
PB SLEEPER SHOCK COVERS  
- 379,389 - 1 LG CURVED FULL COVER

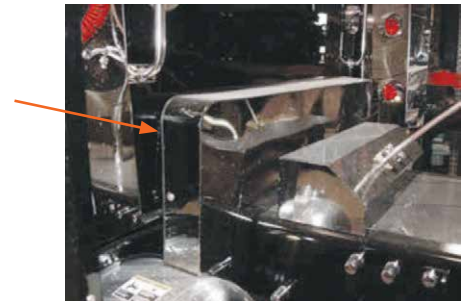

RUBBER STRIP & HARDWARE INCLUDED

## AIR DEFLECTORS



**VP110016**  
PB 359 - 379, 389 WINDOW  
AIR DEFLECTORS  
TAPE MOUNT



**VP110031**  
PB 359 - 379, 389 WINDOW  
AIR DEFLECTORS W/LOWER  
LOOKS( VP110017 )WINDOW  
TRIM 37.25" X 20.375"  
TAPE MOUNT

# PETERBILT MODELS 388 & 389

## FUEL TANK STRAP COVERS

BRACKETS & MOUNTING HARDWARE INCLUDED



**VP150020**  
PB - FUEL TANK STRAP  
COVERS - 4PCS



**VP150029**  
PB - FUEL TANK STRAP  
COVERS - 2PCS  
NOT 359



**VP150029R**  
PB - FUEL TANK STRAP  
COVERS - ROUND - 2PCS  
ALL BUT 359



## EXHAUST COVERS



**VP150021**  
PB - 389 EXHAUST COVER -  
PASSENGER SIDE - FITS 06  
FITS 06 - JULY 07



**VP150022**  
PB - 389 EXHAUST COVER -  
DRIVERS SIDE - FITS 06 - JULY  
FITS 06 - JULY 07



**VP150023**  
PB - 388, 389 EXHAUST COVER  
- PASSENGER & DRIVERS SIDE  
FITS 06 - JULY 07



# PETERBILT MODELS 388 & 389

## TOOL & BATTERY BOX COVERS

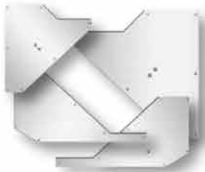

**VP150000**  
PB BATTERY BOX STAINLESS  
COVER KIT - 389 - 2013-OLDER  
- 4 PCS

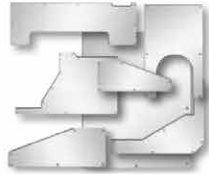

**VP150009**  
PB TOOL BOX STAINLESS  
COVER KIT - 389 - 2013-OLDER  
- CATALYTIC COVER PASS  
SIDE - 7 PCS



**VP150005**  
PB TOOL BOX COVER - 389



**VP150006**  
PB BATTERY BOX COVER - 389  
WITH 1" LIP



**VP150007**  
PB TOOL & BATTERY BOX  
COVERS - 389 WITH 1" LIP - 2 PCS



**VP150008**  
PB TOOL & BATTERY BOX  
STEP TRIMS - 389 - 4 PCS



**VP150014**  
PB 389 TOOL BOX FILLER  
BLOCK FOR BOTTOM STEP



**VP150018**  
PB 389 BATTERY BOX COVER  
MOLDED - 3PCS



**VP150019**  
PB 389 BATTERY BOX LOWER  
STEP COVER W/SIDES - 3PCS



**VP150024**  
PB - 389 UREA CATALYTIC  
COVER 3PC COVER - '12 AND  
OLDER



**VP150025**  
PB - 389 UREA CATALYTIC  
COVER HIGHLIGHT - UPPER -  
'12 AND OLDER



**VP150042**  
PB - 389 - 2014 UREA  
CATALYTIC COVER HIGHLIGHT  
- SIDES - 2PCS



**VP150027**  
PB - 389 - 2013-OLDER UREA  
CATALYTIC COVER HIGHLIGHT  
- SIDES - 2PCS



**VP150026**  
PB - 389 UREA CATALYTIC  
COVER HIGHLIGHT - LOWER

ADD "P" FOR PAINTABLE

# PETERBILT MODELS 388 & 389

## BATTERY BOXES & TOOL BOXES

STANDARD WIDTH 30" / CUSTOM WIDTHS AVAILABLE UP TO 48"



VP150112 - PB - 379,388, 389 REAR TOOL BOX - STAINLESS W/LOCKS - MOULDED LID

VP150113 - PB - 379, 388, 389 BATTERY BOX - STAINLESS W/LOCKS - MOULDED LID



VP150109R - PB - 379, 388, 389 REAR TOOL BOX - STAINLESS W/LOCKS - ROUNDED SMOOTH LOOK

VP150110R - PB - 379, 388, 389 BATTERY BOX - STAINLESS W/LOCKS - ROUNDED SMOOTH LOOK

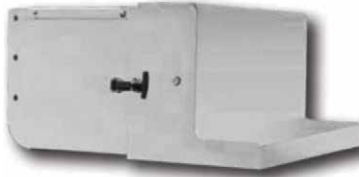

VP150115 - PB - 379,388, 389 REAR TOOL BOX - STAINLESS W/LOCKS - MOULDED LID

VP150116 - PB - 379, 388, 389 BATTERY BOX - STAINLESS W/LOCKS - MOULDED LID

VP150116TM - PB - 379, 388, 389 BATT. BOX - STAINLESS W/TIE DOWNS - 18" TALL MOULDED LID

ADD 36 TO ANY STAINLESS TOOL BOX PART NUMBER FOR A 36" BOX  
ADD -48 TO ANY STAINLESS TOOL BOX PART NUMBER FOR A 48" BOX



**VP150103**  
PB - 379, 388, 389 BATTERY BOX - ALUMINUM



**VP150104**  
PB - 379, 388, 389 BATTERY BOX - ALUMINUM



## BOX STEP HIGHLIGHTS/PROTECTORS



**VP150030**  
PB TOOL BOX/BATTERY BOX - STEP PROTECTOR-(18") - WICKED PR

**VP150031**  
PB TOOL BOX/BATTERY BOX - STEP PROTECTOR- (30") WICKED PAIR

PAINTED OPTIONS SHOWN





**PETERBILT MODEL 567**



# **PETERBILT MODEL 567**

## **CAB PANEL**

*MOUNTING HARDWARE INCLUDED*



**VP110277**

PB CAB PANELS - 567 - BLANK

## **SLEEPER PANELS**

*MOUNTING HARDWARE INCLUDED*



**VP140283**

PB SLEEPER PANELS -  
567 - 80" - BLANK W/REAR  
EXHAUST



**VP142079**

PB SLEEPER PANELS - 567 & 579 - 80" -  
EXHAUST BEHIND SLEEPER

## **HOOD EXTENSION PANELS**



**VP110401**

PB 567 - HOOD EXTENSION  
PANEL - FILLER PANEL



**VP110402**

PB 567 - HOOD EXTENSION  
PANEL - FACTORY LAYOVER  
TAPE MOUNT

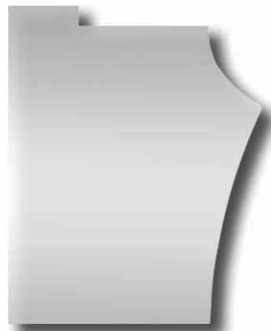

**VP110403**

PB 567 - HOOD  
EXTENSION PANEL - WIDE  
REPLACEMENT - BLANK - PAIR

## **FENDER GUARDS**



**VP120019**

PB FENDER GUARD - 567  
FITTED 4PCS. UPPER &  
LOWER



# **PETERBILT MODEL 567**

## **BUG SHIELDS**



**VP120114**  
PB BUG SHIELD - STAINLESS  
567, 579  
MOUNTING HARDWARE INCLUDED

## **FUEL TANK STRAP COVERS**

BRACKETS & MOUNTING HARDWARE INCLUDED



**VP150048**  
PB - 567 FUEL TANK STRAP  
COVERS - 4PCS



# PETERBILT MODEL 567

## STAINLESS VISORS

**VP130007**

PB - 12" - DROP VISOR 2013 579 DAY CAB  
ALSO FITS MODEL 567

**PAINTABLE  
VISORS  
AVAILABLE**

JUST ADD "P" TO THE END  
FOR PAINTABLE. EXAMPLE:

**VP130007P**  
RAW 18 GAUGE STEEL



PAINTABLE CUSTOM VISOR SHOWN  
VP130007P-16-10BY

**BUILD A CUSTOM VISOR – SEE PAGES 92-93**

**FOR MORE PETE VISORS SEE PAGES 182-185**



**PETERBILT MODEL 579**





**PETERBILT MODEL 579**

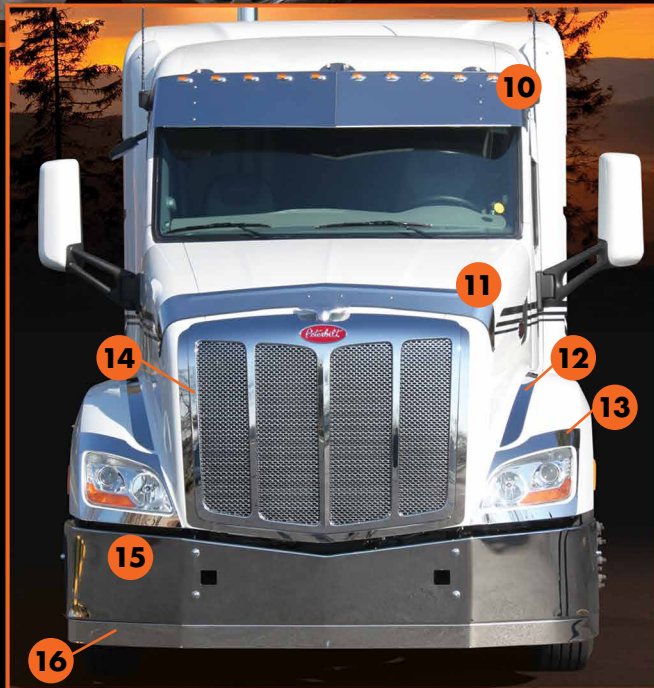

- 1 VP110028** Top of door trim – “lowered” look
- 2 VP140029** Sleeper door handle outer trim with fire extinguisher cutout
- 3 VP142077** Sleeper panels – driver & pass. sides (shown with optional light cutouts)
- 4 VP150112-21** Tool box 21”
- 5 VP150032** Fuel tank fairing upper highlight trim
- 6 VP150034** Kick panel trim
- 7 VP110271** Cab panel with heater plug cutout (shown with optional light cutouts)
- 8 VP110029** Lower door highlight trim
- 9 VP100127** Fender highlight trim (4 pcs driver & passenger sides)
- 10 VP130008** Visor
- 11 VP120114** Bug shield
- 12 VP100126** Fender highlight, 2 pcs (inner well)
- 13 VP120018** Fender guards
- 14 VP100034** Front hood bug guards (3 pcs.)
- 15 HZ-0010-16Y** Front bumper (other options available)
- 16 HZ-SP** Front bumper air dam

# PETERBILT MODEL 579

## CAB PANELS

MOUNTING HARDWARE INCLUDED  
ULTRA AND ULTRA LOFT CABS USE SAME PANELS



**VP110270**  
PB CAB PANELS - 579 - BLANK - 2 PCS



**VP110271**  
PB CAB PANELS - 579 - BLANK  
W/HEATER PLUG HOLE - 2 PCS



**VP110276**  
PB CAB PANELS - 579 - BLANK -  
SHORT HOOD - 2016



**VP110272**  
PB CAB PANELS - 579 DAY  
CAB OR VERT EXHAUST  
BLANK - 2 PCS



**VP110273**  
PB CAB PANELS - 579 DAY CAB OR  
VERT EXHAUST- BLANK W/HEATER  
PLUG HOLE - 2 PCS

## SLEEPER PANELS

MOUNTING HARDWARE INCLUDED



**VP142075**  
PB SLEEPER PANELS - 579  
- 36" / 44" - EXHAUST BEHIND  
SLEEPER



**VP142077**  
PB SLEEPER PANELS - 579 -  
63" / 72" - BLANK



**VP142078**  
PB SLEEPER PANELS - 579  
- 80" - BLANK W/FRONT  
EXHAUST



**VP142079**  
PB SLEEPER PANELS - 579 - 80" -  
EXHAUST BEHIND SLEEPER

**BUILD A CUSTOM PANEL – SEE PAGES 92-93**

**EXAMPLE:**



**VP110271-4GMA**

# PETERBILT MODEL 579

## DEF SYSTEM PANELS

BRACKETS & MOUNTING HARDWARE INCLUDED



**VP150043**  
PB - 579 DEF CATALYTIC  
COVER HIGHLIGHT - UPPER

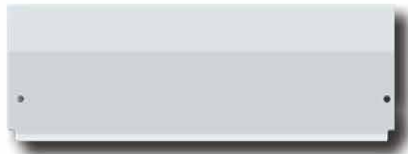

**VP150044**  
PB - 579 DEF CATALYTIC  
COVER HIGHLIGHT - LOWER



**VP150045W**  
PB - 579 DEF CATALYTIC  
LOWER STEP COVER - WING STYLE



**VP150046**  
PB - 579 DEF CATALYTIC  
EXHAUST COVER -  
DYNAFLEX EXHAUST



VP150046

VP150043

VP150044

VP150045W



# PETERBILT MODEL 579

## MISC. TRIM PIECES



**VP100126**  
PB 579 FENDER  
HIGHLIGHT - INNER WELL 2 PCS  
TAPE MOUNT



**VP100127**  
PB 579 FENDER  
TRIM DS/PS - 4PC  
TAPE MOUNT



**VP100034**  
PB 579 FRONT HOOD GRILLE SURROUND  
TAPE MOUNT



**VP110028**  
PB 579 TOP OF DOOR TRIM -  
LOWERED LOOK - PAIR  
TAPE MOUNT

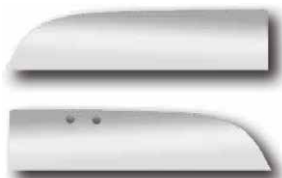

**VP110030**  
PB 579 TOP OF DOOR TRIM -  
LOWERED LOOK - PAIR - W/MIRROR  
HOLES PASS. SIDE





# PETERBILT MODEL 579

## MISC. TRIM PIECES

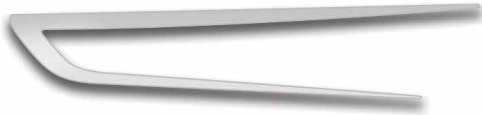

**VP110029**  
PB - 579 LOWER DOOR  
HIGHLIGHT - 2PC



**VP120018**  
PB FENDER GUARD - 579  
FITTED 4PCS. UPPER &  
LOWER



**VP120114**  
PB BUG SHIELD - STAINLESS  
567, - 579  
MOUNTING HARDWARE INCLUDED

# PETERBILT MODEL 579

## STAINLESS VISORS



**VP130007**

PB - 12" - DROP VISOR 2013 TO 2019 579 DAY CAB ONLY/ULTRA CAB  
ALSO FITS MODEL 567, DOES NOT FIT ULTRA LOFT

**VP130008**

PB - 14" - DROP VISOR 2013 579 RAISED ROOF  
NOTE: MOUNTS TO EXISTING FACTORY VISOR BRACKETS  
NO OTHER MOUNTING BRACKETS PROVIDED

**PAINTABLE  
VISORS  
AVAILABLE**

JUST ADD "P" TO THE END  
FOR PAINTABLE. EXAMPLE:

**VP130008-P**  
RAW 18 GAUGE STEEL



VP130008P-10GMA SHOWN

### BUILD A CUSTOM VISOR – SEE PAGES 92-93



**VP132008**

PB - 18" GANGSTER VISOR - FITS 579  
ULTRA CAB ONLY, DOES NOT FIT ULTRA LOFT



**VP132008-BF**

PB - 18" GANGSTER VISOR -  
BUTTERFLY - FITS 579  
ULTRA CAB ONLY, DOES NOT FIT ULTRA LOFT

FOR MORE PETE VISORS SEE PAGES 182-185

# PETERBILT MODEL 579

## SLEEPER SHOCK COVERS



**VP140037**  
PB SLEEPER SHOCK/  
BREATHER COVER - 579 FULL COVER  
RUBBER STRIP & MOUNTING  
HARDWARE INCLUDED



**VP140036**  
PB SLEEPER BREATHER  
COVERS - 579 - 2 PCS ANGLED  
TAPE MOUNT



**VP140038**  
PB SLEEPER SHOCK COVER -  
579 FULL COVER  
RUBBER STRIP & MOUNTING  
HARDWARE INCLUDED

## TANK FAIRING HIGHLIGHT



**VP150032**  
PB - 579 FUEL TANK FAIRING  
UPPER HIGHLIGHT - 2PCS  
TAPE MOUNT



## KICK PANEL TRIM



**VP150034**  
PB - 579 DOOR ENTRY KICK  
PANELS - 2PCS



# PETERBILT MODEL 587

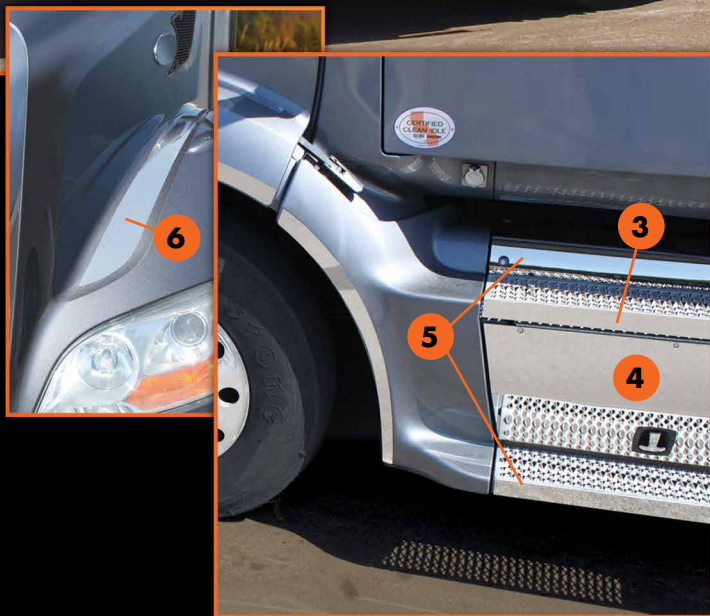

- 1 VP13011** Drop visor, 16", for raised roof
- 2 VP100129** Outer fender trim kit (4 pieces – driver & pass. sides)
- 3 VP150036** Door entry kick panels (2 pieces – driver & pass. sides)
- 4 VP150037** Tool box / battery box cover (One pair – driver & pass. sides)
- 5 VP150038** Step highlights, upper & lower (4 pieces – driver & pass. sides)
- 6 VP100128** Fender inner highlight (2 pieces – driver & pass. sides)
- 7 HOA-0010-16** Chrome bumper, 16" wide (other options available)
- 8 HOA-SP** Stainless air dam for bumper

# PETERBILT MODEL 587

## FENDER TRIM



**VP100128**  
PB 587 FENDER  
HIGHLIGHT DS/PS - 2PC



**VP100129**  
PB 587 FENDER  
TRIM DS/PS - 4PC



## STAINLESS VISORS

**PAINTABLE  
VISORS  
AVAILABLE**

JUST ADD "P" TO THE END  
FOR PAINTABLE. EXAMPLE:

**VP130011P**  
RAW 18 GAUGE STEEL

**VP130011**  
PB - 587 16" DROP VISOR - 2011 AND NEWER RAISED ROOF



**BUILD A CUSTOM VISOR – SEE PAGES 92-93**

# **PETERBILT MODEL 587**

## **MISC. TRIM PIECES**



**VP150036**  
PB - 587 DOOR ENTRY KICK  
PANELS - 2PCS



**VP150037**  
PB - 587 TOOL/BATTERY BOX  
COVER - 2 PCS



**VP150038**  
PB - 587 O STEP HIGHLIGHTS  
- 4 PCS





# ACCESSORIES FOR ALL PETERBILT MODELS





# ALL PETERBILT MODELS

## HOOD EMBLEMS

PETERBILT LOGO EMBLEM NOT INCLUDED



**VP100004**  
EMBLEM ACCENT PB  
TEAR DROP - 2PC  
TAPE MOUNT



**VP100005**  
EMBLEM ACCENT PB  
TEAR DROP W/CUTOUTS - 2PC  
TAPE MOUNT



**VP100006**  
EMBLEM ACCENT PB  
ELLIPSE W/CUTOUT - PAIR  
INCLUDES MOUNTING HARDWARE



**VP100007**  
EMBLEM ACCENT PB  
SKULL & CROSSBONES - PAIR  
TAPE MOUNT



**VP100008**  
EMBLEM ACCENT PB  
CHECKERED FLAG - PAIR  
INCLUDES MOUNTING HARDWARE



**VP100010**  
EMBLEM ACCENT PB  
WILD FIRE - PAIR  
TAPE MOUNT



**VP100011**  
EMBLEM ACCENT PB  
FLAMES - 2PC  
INCLUDES MOUNTING HARDWARE



**VP100013**  
EMBLEM ACCENT PB  
OVAL - PAIR  
TAPE MOUNT



**VP100012**  
EMBLEM ACCENT PB  
CHEVRON - PAIR  
TAPE MOUNT

# ALL PETERBILT MODELS

## HOOD EMBLEMS

PETERBILT LOGO EMBLEM NOT INCLUDED



**VP100014**  
EMBLEM ACCENT PB  
OVAL - W/CUTOUTS - PAIR  
INCLUDES MOUNTING  
HARDWARE



**VP100015**  
EMBLEM ACCENT PB  
OVAL - W/SPADES - PAIR  
TAPE MOUNT



**VP100016**  
EMBLEM ACCENT PB  
OVAL - W/2-EXTENSIONS - PAIR  
TAPE MOUNT



**VP100017**  
EMBLEM ACCENT PB  
OVAL - W/3-EXTENSIONS - PAIR  
TAPE MOUNT



**VP100018**  
EMBLEM ACCENT PB  
SWIRL - 2PC  
INCLUDES MOUNTING  
HARDWARE



**VP100027**  
EMBLEM ACCENT PB -  
FISH - PAIR  
INCLUDES MOUNTING  
HARDWARE



**VP100029**  
EMBLEM ACCENT PB -  
FLAMES - 2PCS.  
INCLUDES MOUNTING  
HARDWARE



**VP100019**  
EMBLEM ACCENT PB  
SWIRL - W/CUTOUTS - 2PC  
INCLUDES MOUNTING  
HARDWARE

## HOOD LATCH GUARDS



**VP100022**  
PB HOOD LATCH TRIM  
STANDARD HOOD - 2PC



**VP100024**  
PB HOOD LATCH TRIM  
EXTENDED HOOD - 2 PC



**VU190011**  
PB, FL, KW, HOOD LATCH  
ACCENT TRIM - PAIR

# ALL PETERBILT MODELS

## KEY GUARDS

STRONG 3M DOUBLE-SIDED TAPE INCLUDED



**VP110001**  
PB KEY GUARD  
FLAME - PAIR



**VP110002**  
PB KEY GUARD  
TEAR DROP - PAIR



**VP110003**  
PB KEY GUARD  
CHECKERED FLAG - PAIR



**VP110004**  
PB KEY GUARD  
TRIANGLE - PAIR



**VP110005**  
PB KEY GUARD  
OVAL -PAIR



**VP110006**  
PB KEY GUARD  
ELLIPSE W/CUTOUT - PAIR



**VP110007**  
PB KEY GUARD  
WILDFIRE - PAIR



**VP110008**  
PB KEY GUARD - FISH

## MISC. TRIM PIECES

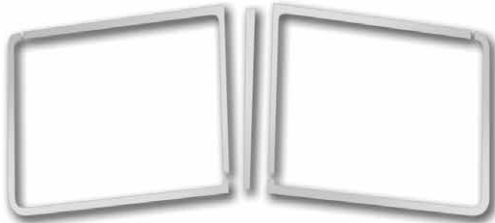

**VP110014**  
PB WINDSHIELD TRIM 3 PC



**VP110021**  
PB WINDSHIELD TRIM 5 PC



**VP110011**  
PB CAB MOUNTED MIRRORS  
DOOR LATCH/KEY HOLE  
COVERS - 2PC

## **ALL PETERBILT MODELS**

### **BUG SHIELD - MODEL 387**



**VP120108**  
PB BUG SHIELD - STAINLESS  
PETE - 387  
MOUNTING HARDWARE INCLUDED

### **WINDOW TRIM**

*MOUNTS WITH STRONG 3M DOUBLE-SIDED TAPE*



**VP140001**  
PB RECTANGULAR  
VIEW WINDOW  
TRIM RING



**VP140002**  
PB 70" SLEEPER  
WINDOW TRIM - PAIR



**VP140003**  
PB SLEEPER/DAY CAB REAR  
WINDOW TRIM 37.25" X 20.375"

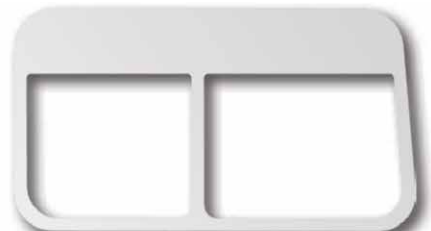

**VP140014**  
PB 70" SLEEPER WINDOW TRIM  
- LOWERED LOOK PR

### **SLEEPER WINDOW LOWER LOOKS**

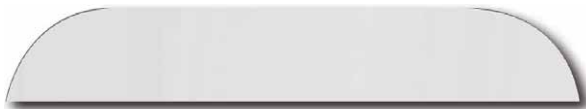

**VP140117**  
PB TOP OF DOOR TRIM - LOWERED LOOK - PR  
WILL ONLY FIT DOORS WITHOUT VENT WINDOW

**ADD -P FOR PAINTABLE**



# PETERBILT SUN VISORS BY CAB TYPE

## STANDARD MOUNT STAINLESS VISORS

BRACKETS AND MOUNTING HARDWARE INCLUDED  
AVAILABLE IN 304 STAINLESS STEEL – CALL FOR PRICING



**VP130000**  
PB-14" - DROP VISOR 1996-98 ULTRA CAB

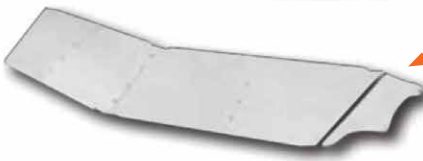

**VP130001**  
PB - 359 12" DROP VISOR - ANY YEAR 359

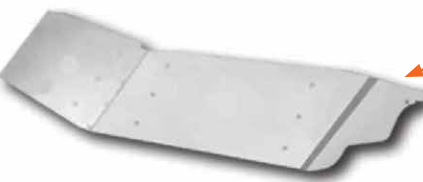

**VP130002**  
PB-14" - DROP VISOR - STANDARD CAB 2005 & OLDER WITH DOOR MOUNTED MIRRORS



**VP130002-16**  
PB - 16" - DROP VISOR - STANDARD CAB 2005 & OLDER. NOTE 04 AND OLDER DOOR MNT MIRRORS

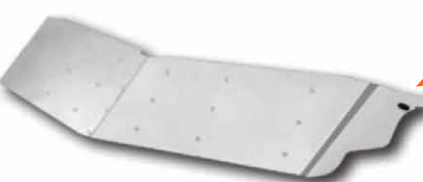

**VP130003**  
PB - 14" - DROP VISOR - 1999-2001 ONLY, ULTRACAB

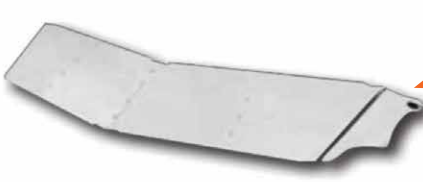

**VP130003-16**  
PB-16" - DROP VISOR 1999 - 2001 ULTRACAB



**VP130004**  
PB - 14" - DROP VISOR - 2002 - 2005 ULTRACAB WITH DOOR MOUNTED MIRRORS

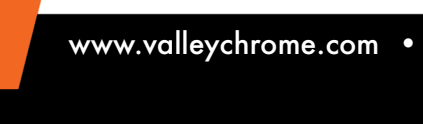

**VP130004-16**  
PB - 16" - DROP VISOR - 2002 - 2005 ULTRACAB WITH DOOR MOUNTED MIRRORS



**VP130005**  
PB - 14" - DROP VISOR - 2005 - NEWER ULTRACAB - W/CAB MOUNTED MIRRORS



**VP130005-16**  
PB - 16" - DROP VISOR - 2005 - NEWER ULTRACAB W/CAB MOUNTED MIRRORS



**VP130006**  
PB - 13.5" - DROP VISOR - 2005 - NEWER STANDARD CAB W/CAB MOUNTED MIRRORS. ALSO FITS MODEL 348



**VP130006-16**  
PB - 16" - DROP VISOR - 2005 - NEWER STANDARD W/CAB MOUNTED MIRRORS ALSO FITS MODEL 348



**VP130005**

**PAINTABLE VISORS AVAILABLE**

JUST ADD "P" TO THE END FOR PAINTABLE. EXAMPLE:

**VP130002-P**  
RAW 18 GAUGE STEEL

BUILD A CUSTOM VISOR – SEE PAGES 92-93 FOR LIGHT OPTIONS

# PETERBILT SUN VISORS BY CAB TYPE

## **BOLTLESS MOUNT STAINLESS VISORS**

BRACKETS AND MOUNTING HARDWARE INCLUDED  
AVAILABLE IN 304 STAINLESS STEEL – CALL FOR PRICING

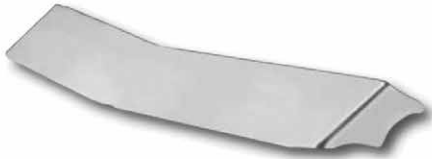

**VP131002**  
PB-14" - BOLTLESS - DROP VISOR -  
STANDARD CAB 2005 & OLDER -  
DOOR MOUNTED MIRRORS - 1 PC

**VP131002-16**  
PB-16" - BOLTLESS - DROP VISOR -  
STANDARD CAB 2005 & OLDER -  
DOOR MOUNTED MIRRORS - 1 PC

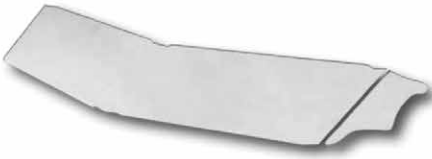

**VP131003**  
PB-14" - BOLTLESS - DROP VISOR -  
1999 - 2001 - ULTRACAB - 1 PC

**VP131003-16**  
PB-16" - BOLTLESS - DROP VISOR -  
1999 - 2001 - ULTRACAB - 1 PC

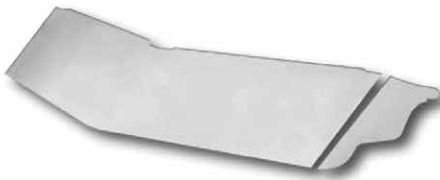

**VP131004**  
PB - 14" - BOLTLESS - DROP VISOR  
- 2002 - 2005 ULTRACAB WITH  
DOOR MOUNTED MIRRORS - 1 PC

**VP131004-16**  
PB - 16" - BOLTLESS - DROP VISOR  
- 2002 - 2005 ULTRACAB WITH  
DOOR MOUNTED MIRRORS - 1 PC



**VP131005**  
PB - 14" - BOLTLESS DROP VISOR  
2005 + ULTRACAB ONE PIECE W/CAB  
MT MIRRORS

**VP131005-16**  
PB - 16" - DROP VISOR 2005 + ULTRACAB  
ONE PIECE W/CAB MT MIRRORS



**VP131006**  
PB - 14" - BOLTLESS - DROP VISOR -  
2005 - NEWER STANDARD W/CAB  
MOUNTED MIRRORS - 1 PC

**VP131006-16**  
PB - 16" - BOLTLESS DROP VISOR -  
2005 - NEWER STANDARD W/CAB  
MOUNTED MIRRORS - 1 PC

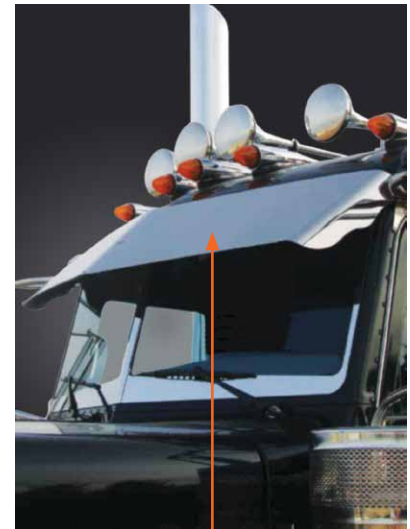

VP130005

**COOL  
BOLTLESS  
LOOK!**

**PAINTABLE  
VISORS  
AVAILABLE**

JUST ADD "P" TO THE END  
FOR PAINTABLE. EXAMPLE:

**VP131002-P**  
RAW 18 GAUGE STEEL

**BUILD A CUSTOM VISOR – SEE PAGES 92-93 FOR LIGHT OPTIONS**



# PETERBILT WICKED VISORS

## BOLTLESS STAINLESS VISORS

BRACKETS AND MOUNTING HARDWARE INCLUDED  
AVAILABLE IN 304 STAINLESS STEEL – CALL FOR PRICING



**VP135000**  
PB - 14" WICKED - DROP VISOR  
1996-98 ULTRA CAB - 2 PC

**VP135001**  
PB - 12" WICKED - DROP  
VISOR - ANY YEAR 359 - 2PC

**VP135002**  
PB - 14" WICKED - DROP  
VISOR - STANDARD CAB  
2005 & OLDER W/DOOR  
MOUNTED MIRRORS - 2 PC



**VP135003**  
PB - 14" WICKED - DROP  
VISOR 1999-2001 ULTRA  
CAB - 2PC

**VP135004**  
PB - 14" WICKED - DROP  
VISOR - 2002 - 2005  
ULTRACAB WITH DOOR  
MOUNTED MIRRORS - 2 PC

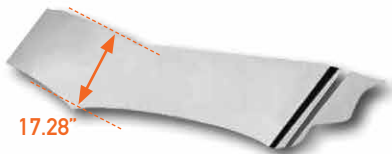

**VP135005**  
PB - 14" WICKED - DROP  
VISOR - 2005 - NEWER  
ULTRACAB W/CAB MOUNTED  
MIRRORS - 2 PC

**VP135006**  
PB - 14" WICKED - DROP  
VISOR - 2005 - NEWER  
STANDARD W/CAB  
MOUNTED MIRRORS - 2 PC



**VP136002**  
PB - 13" WICKED  
GANGSTER VISOR - FITS  
ANY - 370 SERIES & 380  
SERIES - 2 PC



VP130006

YOU SAY  
**WICKED**  
LIKE IT'S A BAD THING

**COOL  
BOLTLESS  
LOOK!**



**BUILD A CUSTOM VISOR – SEE PAGES 92-93 FOR LIGHT OPTIONS**

# PETERBILT SUN VISORS

## GANGSTER STAINLESS VISORS

BRACKETS AND MOUNTING HARDWARE INCLUDED  
MADE WITH 16 GAUGE GRADE 430



**VP132002**  
PB - 12" GANGSTER VISOR - FITS ANY - 370 SERIES & 380 SERIES 2 PC



**VP132002-BF**  
PB - 12" GANGSTER BUTTERFLY VISOR - FITS ANY 370 SERIES & 380 SERIES 2 PC



**VP132002P-BF**  
PB - 12" GANGSTER BUTTERFLY VISOR PAINTABLE - FITS ANY 370 SERIES & 380 SERIES 2 PC



**VP132002-RBF**  
PB - 12" GANGSTER REVERSE BUTTERFLY VISOR - FITS ANY - 370 SERIES & 380 SERIES 2 PC



**VP132002P-RBF**  
PB - 12" GANGSTER REVERSE BUTTERFLY VISOR PAINTABLE - FITS ANY - 370 SERIES & 380 SERIES 2 PC



**VP132002-BT**  
PB - 12" GANGSTER BOWTIE VISOR - FITS ANY 370 SERIES & 380 SERIES 2 PC



**VP132002P-BT**  
PB - 12" GANGSTER BOWTIE VISOR PAINTABLE - FITS ANY 370 SERIES & 380 SERIES 2 PC



**VP132003-BF**  
PB - 12" GANGSTER BUTTERFLY VISOR - FITS 337 DAY CAB



**VP132003P-BF**  
PB - 12" GANGSTER BUTTERFLY VISOR PAINTABLE - FITS 337 DAY CAB



VP132002P-BTP shown



**PAINTABLE VISORS AVAILABLE**

JUST ADD "P" TO THE END FOR PAINTABLE

RAW 18 GAUGE STEEL  
COLORS SHOWN EXAMPLES ONLY

**BUILD A CUSTOM VISOR – SEE PAGES 92-93 FOR LIGHT OPTIONS**

# PETERBILT STAINLESS TRIM

## SLEEPER WRAPS

MOUNTS WITH STRONG 3M DOUBLE-SIDED TAPE



**VP140005**  
PB SLEEPER WRAP -  
FLAG - LG



**VP140007**  
PB SLEEPER WRAP -  
FLAMES - LG



**VP140009**  
PB SLEEPER WRAP - STEER  
HEAD - LG



**VP140006**  
PB SLEEPER WRAP - FLAG -  
SM - UNIBILT STAND-UP

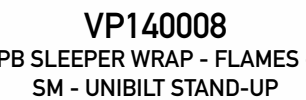

**VP140008**  
PB SLEEPER WRAP - FLAMES -  
SM - UNIBILT STAND-UP

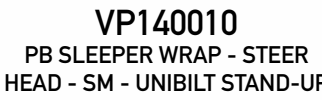

**VP140010**  
PB SLEEPER WRAP - STEER  
HEAD - SM - UNIBILT STAND-UP



**VP140023**  
PB SLEEPER WRAP -  
GIRLS - LG



**VP140018**  
PB SLEEPER WRAP -  
PLAIN - LG - FLAT TOP CAB



**VP140011**  
PB SLEEPER WRAP -  
PLAIN - LG - FLAT TOP - 3PC



**VP140024**  
PB SLEEPER WRAP - GIRLS -  
SM - UNIBILT STAND-UP



**VP140019**  
PB SLEEPER WRAP - PLAIN -  
SM - ULTRA CAB



**VP140012**  
PB SLEEPER WRAP - PLAIN -  
SM - 3PC - UNIBILT STAND-UP



**VP140015**  
PB SLEEPER WRAP - PLAIN -  
SM - SIDES - 2PCS



**VP140016**  
PB SLEEPER WRAP - PLAIN -  
LG - SIDES - 2PCS

## REAR FRAME COVERS

MOUNTS USING EXISTING FRAME BOLTS



**VP160001**  
PB - REAR FRAME COVER -  
379



**VP160003**  
PB - REAR FRAME COVER -  
WILDFIRE



**VP160004**  
PB - REAR FRAME COVER -  
ELLIPSE

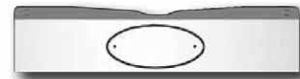

**VP160005**  
PB - REAR FRAME COVER -  
OVAL - W/CUTOUTS

**WILL NOT WORK WITH ALUMINUM FRAMES**



**VP160006**  
PB - REAR FRAME COVER -  
STEER HEAD



**VP160007**  
PB - REAR FRAME COVER -  
GIRLS

# **PETERBILT STAINLESS TRIM**

## **DEF TANK COVERS**

*MOUNTS TO EXISTING HARDWARE*

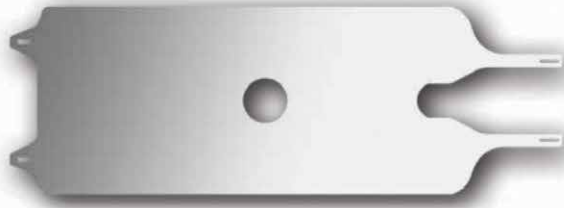

**VP150028**  
DEF FUEL TANK COVER -  
STAINLESS



## **FUEL TANK WRAPS**

*MOUNTS BEHIND FUEL TANK STRAPS  
STRONG 3M DOUBLE-SIDED TAPE ALSO INCLUDED*

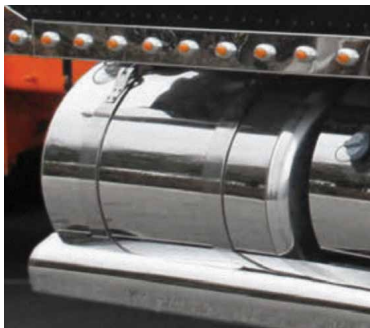

**VP150041-DS**  
DRIVER SIDE  
PB -2012 FUEL TANK WRAP -  
75 GALLON

**VP150041-PS**  
PASSENGER SIDE  
PB -2012 FUEL TANK WRAP -  
75 GALLON

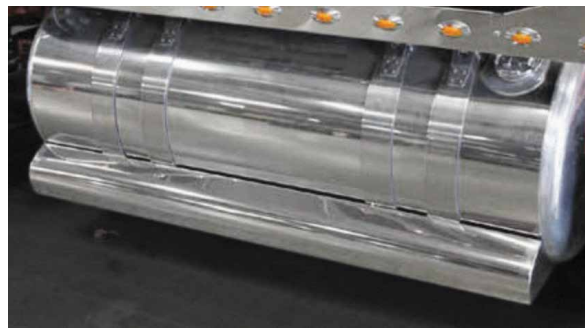

**VP150040**  
DRIVER SIDE  
PB - 2012 FUEL TANK WRAP -  
150 GALLON

**VP150040-PS**  
PASSENGER SIDE  
PB - 2012 FUEL TANK WRAP -  
150 GALLON

*SPECIFY TANK LENGTH, INSIDE WELD TO INSIDE WELD WHEN ORDERING*



**KENWORTH W900**



# KENWORTH W900

## CAB PANELS

MOUNTING HARDWARE INCLUDED



**VK110205**  
W900L - 2014 - HIGHLIGHT -  
BLANK - 2 PCS



**VK110206**  
W900L - 2014 - HIGHLIGHT  
- BLANK - W/ LIGHT HOLE -  
HEATER PLUG HOLE



**VK110200**  
W900L - AEROCAB - CAB  
PANELS - 50.25" - BLANK

*BUILD A CUSTOM PANEL – SEE PAGES 92-93*



**EXAMPLE**  
VK110200-4UN



**EXAMPLE**  
VK110200-5RN

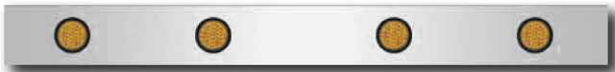

**EXAMPLE**  
VK110200-4RA



**EXAMPLE**  
VK110200-4GA



VK110200-3GA shown



# KENWORTH W900

## SLEEPER PANELS

MOUNTING HARDWARE INCLUDED



**VK142035**

KW SLEEPER PANELS - T600 (1995 & NEWER, NO FAIRINGS) T800 ( 1986 & NEWER ), W900 (1986 & NEWER) - 42" - BLANK



**VK142008**

KW SLEEPER PANELS - AEROCAB - NO SIDE FAIRING - T600, T800, W900 - 60" - BLANK - 1995 & NEWER WRAPS ON BOTH ENDS



**VK142015**

KW SLEEPER PANELS - AEROCAB - NO SIDE FAIRING - T600, T800, W900 - 72" - BLANK



**VK142023**

KW SLEEPER PANELS - AEROCAB - NO SIDE FAIRING - T600, T800, W900 - 86" - BLANK



**VK142030**

KW SLEEPER PANELS - AEROCAB - NO SIDE FAIRING, PASS SIDE NOTCHED FOR EXH - T600, T800, W900 - 62" - BLANK



**VK142100**

KW SLEEPER PANELS - AEROCAB - W/EXHAUST - W900 L - 62" - BLANK



**VK142101**

KW SLEEPER PANELS - AEROCAB - W/EXHAUST - W900 L - 72" - BLANK



**VK142105**

KW SLEEPER PANELS - AEROCAB - W/FUEL DOOR - W900 L - 86" - BLANK



**VK142200**

KW SLEEPER PANELS - 2014 AEROCAB - 62" - BLANK - 2 PCS

*BUILD A CUSTOM PANEL – SEE PAGES 92-93*



**EXAMPLE**  
VK142008-3UN



**EXAMPLE**  
VK142008-5RA



**EXAMPLE**  
VK142023-8GA

# KENWORTH W900

## HOOD EXTENSION PANELS

MOUNTING HARDWARE INCLUDED



**VK110300**  
HOOD EXTENSION PANELS -  
W900L - BLANK - 1997-2004 -  
2 PCS



**VK110305**  
HOOD EXTENSION PANELS -  
W900L - BLANK - 2014 - 2 PCS

*BUILD A CUSTOM PANEL – SEE PAGES 92-93*



**EXAMPLE**  
VK110300-3UN



**EXAMPLE**  
VK110300-4GA



## SLEEPER EXTENSION PANELS

MOUNTING HARDWARE INCLUDED



**VK143001**  
SLEEPER EXTENSION PANELS  
- T600, T800, W900 - BLANK -  
1992 - 2012



**EXAMPLE**  
VK143001-1GA

# KENWORTH W900

## AIR CLEANER LIGHT BOXES

MOUNTING HARDWARE INCLUDED



**VK113000**  
AIR CLEANER LIGHT BOXES -  
W900 - FRONT - BLANK



**VK113001**  
AIR CLEANER LIGHT  
BOXES - W900 - CENTER  
MOUNT - FRONT - BLANK



**VK110020**  
AIR CLEANER LIGHT BOXES -  
W900 - REAR - BLANK



**VK112209**  
KW - AIR CLEANER  
SUPPORT - BLANK -  
W900L - 2014 - PAIR

BUILD A CUSTOM PANEL – SEE PAGES 92-93

EXAMPLE:



**VK113000-8RA**  
AIR CLEANER LIGHT BOXES -  
W900 - FRONT - 8 ROUND AMBERS



# **KENWORTH W900**

## **AIR CLEANER FAIRINGS**



**VK100013**  
AIR CLEANER FAIRING W9L PR



**VK100020**  
AIR CLEANER FAIRING W9L  
PR 2014



**VK100022**  
AIR CLEANER FAIRING W9L PAIR  
2014 - SLIM VERSION



# KENWORTH W900

## EXTERIOR WINDOW TRIM

MOUNTS WITH STRONG 3M DOUBLE-SIDED TAPE



**VK110021**  
2014 KW WINDSHIELD  
TRIM - 4 PC - W900 CURVED  
WINDSHIELD



**VK110018**  
2014 KW WINDSHIELD TRIM  
- 6 PC - W900 - CURVED  
WINDSHIELD - LARGE

## EXHAUST SHIELDS

BRACKETS AND MOUNTING HARDWARE INCLUDED



**VK110090**  
KW EXHAUST SHIELD W/NO  
LOGO W900B



## BUG SHIELDS

MOUNTING HARDWARE INCLUDED



**VK120005**  
KW BUGSHIELD & TRIM -  
HIGHLIGHTED - W900L -  
1989 & NEWER  
BLACK PLASTIC &  
STAINLESS HIGHLIGHT



**VK120006**  
KW BUGSHIELD & TRIM -  
FLAMED - W900L -  
1989 & NEWER  
BLACK PLASTIC &  
STAINLESS HIGHLIGHT



**VK120023**  
KW BUGSHIELD TRIM - W900L -  
HIGHLIGHT ONLY  
STAINLESS HIGHLIGHT



**VK120024**  
KW BUGSHIELD TRIM - W900L -  
FLAME - ONLY  
STAINLESS HIGHLIGHT



**VK120009**  
KW STAINLESS BUG SHIELD  
- 900L



**VK120010**  
KW STAINLESS BUG SHIELD  
- 900B

# **KENWORTH W900**

## **BLINKER BARS**

*RUBBER TRIM AND MOUNTING HARDWARE INCLUDED*



**VK120501**  
KW - W900L FRONT BLINKER  
BARS W/LIGHTS



**VK100501**  
KW - W900L REAR BLINKER  
BARS W/LIGHTS



**VK120501BL**  
KW - W900L FRONT BLINKER  
BARS BLANK

*BUILD A CUSTOM BLINKER BAR – SEE PAGES 92-93*



## **FLAP WEIGHTS**



**VK190001**  
2014 W900 L - FRONT FENDER  
FLAP WEIGHTS - 2 PCS



**KENWORTH W900**

**FENDER GUARDS**



**VK120019**



**VK120016**  
KW - FENDER GUARDS -  
W900L - 1989 & NEWER - PAIR



**VK120017**  
KW - FENDER GUARDS -  
W900L - FLUSH MOUNT  
1989 & NEWER - PAIR



**VK120019**  
KW - FENDER GUARDS -  
W900B - FLUSH MOUNT  
1989 & NEWER - PAIR

**BATTERY & TOOL BOX COVERS**



**VK150004**  
KW - BATTERY BOX COVER -  
T600, T800, W900 - 39.5" X 9.0"



**VK150005**  
KW - BATTERY BOX COVER -  
T600, T800, W900 - 45" X 9"



**VK150006**  
KW - TOOL BOX COVER - T600,  
T800, W900 - 39.5" X 8.5"



**VK150007**  
KW - TOOL BOX COVER - T600,  
T800, W900 - 45" X 8.5"

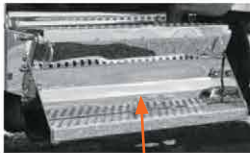

**VK150030**  
2014- W900 L - BATTERY BOX  
STEP COVER



**VK150031**  
2014- W900 L - BATTERY  
COVER HIGHLIGHT - 2 PCS



**VK150032**  
2014- W900 L - BATTERY BOX  
STEP HIGHLIGHT - 5 PCS

# KENWORTH W900

## HOOD & GRILLE TRIM



**VK120002**  
W9L LOWER GRILL FILTER TRIM



**VK120001**  
W900L TOP GRILL  
DEFLECTORS - PAIR



**11151**  
HOOD WING -  
POWER STYLE



**11191**  
FENDER WINGS -  
POWERSTYLE



**22281**  
SIDE HOOD WINGS



**VK120007**  
KW SIDE GRILL DEFLECTOR -  
FULL LENGTH - W900L



**VK120008**  
KW SIDE GRILL DEFLECTOR -  
FOR USE WITH BLINKER BAR  
- W900L



**VK120004**  
KW SIDE GRILL DEFLECTORS



VK120008

# KENWORTH W900

## STAINLESS SUN VISORS

MOUNTING HARDWARE INCLUDED



**VK130001**  
VK-13" - DROP VISOR - W900  
AEROCAB CURVED - 1995 - 2006



VK130001



**VK131001**  
KW - 13" - DROP VISOR - W900  
AEROCAB CURVED 1995 & 2006 -  
1PC - BOLTLESS

**VK130002**  
KW - 13" - DROP VISOR - W900 - CABS W/  
SPLIT FLAT WINDSHIELDS 1984 TO 1998



VK130002



**VK131002**  
KW - 13" - DROP VISOR - W900 - CABS W/  
SPLIT FLAT WINDSHIELDS 1984 TO 1998 -  
1PC - BOLTLESS

**VK130003**  
KW - 13" - DROP VISOR - (W900 2007-  
2013) - (T660, T800 2007-2015)-  
CURVED WINDSHIELD

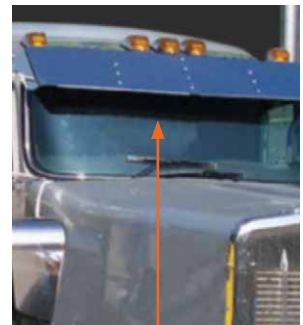

VK130003



**VK131003**  
KW - 13" - DROP VISOR - W900 - T660 -  
CURVED WINDSHIELD - 2007 & NEWER  
- 1PC - BOLTLESS

**VK130004**  
KW - 13" - DROP VISOR - W900 - CABS W/  
SPLIT FLAT WINDSHIELD 1999 TO 2004

**VK131004**  
KW - 13" - DROP VISOR - W900 - CABS W/  
SPLIT FLAT WINDSHIELD 1999 TO 2004 -  
1PC - BOLTLESS

# KENWORTH W900

## GANGSTER VISORS

MOUNTING HARDWARE INCLUDED



**VK132001**  
KW - 12" - GANGSTER VISOR - DROP  
- W900 - CURVED WINDSHIELD - 1995  
- 2006 - 2 PC

EXAMPLE



**VK132003**  
KW - 12" - GANGSTER VISOR -  
DROP - W900, T660, T800 - CURVED  
WINDSHIELD - 2007 & NEWER - 2 PC

**VK132001P**  
KW - 12" - GANGSTER VISOR  
PAINTABLE - DROP - W900 - CURVED  
WINDSHIELD - 1995 - 2006 - 2 PC  
RAW 18-GAUGE STEEL



**VK132001-BF**  
KW - 12" - GANGSTER BUTTERFLY  
VISOR - DROP - W900 - CURVED  
WINDSHIELD - 1995 - 2006 - 2 PC

EXAMPLE



**VK132001P-BF**  
KW - 12" - GANGSTER BUTTERFLY  
VISOR PAINTABLE - DROP - W900 -  
CURVED WINDSHIELD - 1995 - 2006- 2 PC  
RAW 18-GAUGE STEEL



VK132003-BF



VK132003-BF

**ONLY AVAILABLE IN 12"**



# KENWORTH W900

## BOLTLESS WICKED VISORS

MOUNTING HARDWARE INCLUDED



**VK135001**  
 KW - 13" - WICKED - DROP  
 - W900 AEROCAB CURVED  
 1995-2006 - 2 PIECE



**VK135002**  
 KW - 13" - WICKED - DROP  
 - W900 - CABS W/ SPLIT  
 FLAT WINDSHIELDS 1984  
 TO 1998 - 2 PIECE

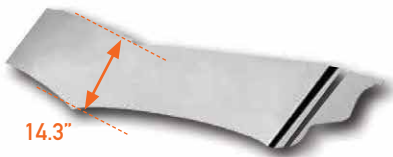

**VK135003**  
 KW - 14" - WICKED -  
 DROP - W900, T660, T800  
 - CURVED WINDSHIELD -  
 2007 & NEWER - 2 PIECE



**VK135004**  
 KW - 13" - WICKED -  
 DROP - W900 - CABS W/  
 SPLIT FLAT WINDSHIELD  
 1999 & NEWER - 2PIECE



**VK136001**  
 KW - 14" - WICKED  
 GANGSTER - W900 -  
 CURVED WINDSHIELD -  
 1995-2006 - 2 PIECE

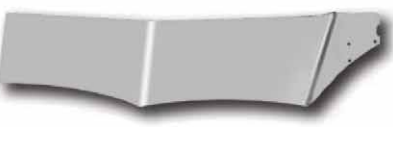

**VK136003**  
 KW - 14" - WICKED  
 GANGSTER - W900,  
 T660, T800 - CURVED  
 WINDSHIELD -  
 2007-NEWER - 2 PIECE

**PAINTABLE  
 VISORS  
 AVAILABLE**

JUST ADD "P" TO THE END  
 FOR PAINTABLE. EXAMPLE:

**VK135002-P**  
 RAW 18 GAUGE STEEL

**COOL  
 BOLTLESS  
 LOOK!**



VK135001

YOU SAY  
**WICKED**  
 LIKE IT'S A BAD THING

**BUILD A CUSTOM VISOR – SEE PAGES 92-93**

# KENWORTH W900

## CATALYTIC SYSTEM BOX HIGHLIGHT



**VK150020**  
2014- W900 L - CATALYTIC  
STEP COVER



**VK150021**  
2014- W900 L - CATALYTIC  
COVER HIGHLIGHT - 2 PCS

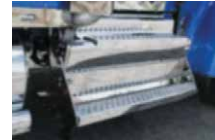

**VK150022**  
2014- W900 L - CATALYTIC  
STEP HIGHLIGHTS - 5 PCS

## DEF TANK COVER

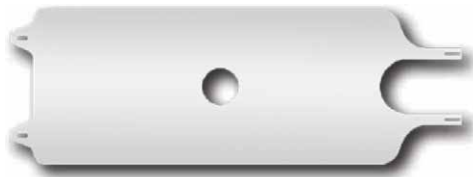

**VK150028**  
KW - 2014 W900 L - DEF  
TANK COVER



## STAINLESS DECK PLATES



**VK192010**  
FRONT DECK PLATE FLUSH MOUNT - W/  
AIR LINE BOX CUTOUT - 2014 W900 L



**VK192011**  
MID DECK PLATE FLUSH MOUNT -  
2014 W900 L - 66"X27"



**VK192012**  
REAR DECK PLATE - FLUSH MOUNT -  
2014 W900 L



# KENWORTH W900

## FUEL TANK FAIRINGS

BRACKETS & MOUNTING HARDWARE INCLUDED  
 NOT AVAILABLE IN 430 STAINLESS  
 FAIRINGS FOR STANDARD WIDTH TANK STRAPS SHOWN



60"

**VK150001**

KW - FUEL TANK FAIRINGS 60"  
 - W900 - 1998 & NEWER - PAIR



66"

**VK150002**

KW - FUEL TANK FAIRINGS 66"  
 - W900 - 1998 & NEWER - PAIR



73"

**VK150003**

KW - FUEL TANK FAIRINGS  
 73" - W900 - 1998 & NEWER - PAIR



**STANDARD**



**VK150001R**

KW - FUEL TANK FAIRINGS  
 60" - ROUND - W900 - 1998 &  
 NEWER



**VK150002R**

KW - FUEL TANK FAIRINGS 14"  
 66" - ROUND - W900 - 1998 &  
 NEWER



**VK150003R**

KW - FUEL TANK FAIRINGS  
 73" - ROUND - W900 - 1998 &  
 NEWER



**ROUNDED**



CUSTOM FAIRINGS FOR WIDE STRAPS SHOWN - CALL FOR YOUR CUSTOM SETUP



**EXAMPLE**

**VK150003-5GA**

BUILD A CUSTOM FAIRING WITH LIGHTS - SEE PAGES 92 93



# **KENWORTH W900**

## **LOWER HOOD PANELS**

*KENWORTH LOGO NOT INCLUDED*



**VK100016**

KW - LOWER HOOD PANELS -  
W900 1989 & NEWER - PR

## **CENTER HOOD TRIM**



**VK100021**

KW - W900L CENTER  
HOOD TRIM  
TAPE MOUNT

# **KENWORTH T600**



*Photo submitted by Tony St Bernard*

# KENWORTH T600

## SLEEPER PANELS



**VK142035**

KW SLEEPER PANELS - T600 (1995 & NEWER, NO FAIRINGS) T800 ( 1986 & NEWER ), W900 (1986 & NEWER ) - 42" - BLANK



**VK142008**

KW SLEEPER PANELS - AEROCAB - NO SIDE FAIRING - T600, T800, W900 - 60" - BLANK - 1995 & NEWER



**VK142015**

KW SLEEPER PANELS - AEROCAB - NO SIDE FAIRING - T600, T800, W900 - 72" - BLANK



**VK142023**

KW SLEEPER PANELS - AEROCAB - NO SIDE FAIRING - T600, T800, W900 - 86" - BLANK



**VK142030**

KW SLEEPER PANELS - AEROCAB - NO SIDE FAIRING , PASS SIDE NOTCHED FOR EXH - T600, T800, W900 - 62" - BLANK

*BUILD A CUSTOM PANEL – SEE PAGES 92-93*



**EXAMPLE**  
VK142008-3UN



**EXAMPLE**  
VK142008-5RA



**EXAMPLE**  
VK142023-8GA

## SLEEPER EXTENSION PANELS

MOUNTING HARDWARE INCLUDED



**VK143001**  
SLEEPER EXTENSION PANELS - T600, T800, W900 - BLANK - 1992 - 2012



**EXAMPLE**  
VK143001-1GA

# **KENWORTH T600**

## **STAINLESS GRILLES**

MOUNTING HARDWARE INCLUDED



**VK120600**  
KW GRILL T600B -  
HORIZONTAL - RIVETED

## **BUG SHIELDS**

MOUNTING HARDWARE INCLUDED



**VK120012**  
KW STAINLESS BUG SHIELD  
- T600



# KENWORTH T600

## BATTERY & TOOL BOX COVERS



**VK150004**

KW - BATTERY BOX COVER -  
T600, T800, W900 - 39.5" X 9.0"



**VK150005**

KW - BATTERY BOX COVER -  
T600, T800, W900 - 45" X 9"



**VK150006**

KW - TOOL BOX COVER -  
T600, T800, W900 - 39.5" X 8.5"



**VK150007**

KW - TOOL BOX COVER -  
T600, T800, W900 - 45" X 8.5"

## SIDE MARKER TRIM



**VK140001**

T600 SIDE MARKER LIGHT  
ACCENT TRIM - PAIR





**KENWORTH T660**



# **KENWORTH T660**

## **CAB PANELS**

*MOUNTING HARDWARE INCLUDED*



**VK110201**  
T660 - CAB PANELS - BLANK"

*BUILD A CUSTOM PANEL – SEE PAGES 92-93*

## **BUG SHIELDS**

*MOUNTING HARDWARE INCLUDED*



**VK120015**  
KW STAINLESS BUG SHIELD  
- T660



## **STAINLESS SUN VISORS**

*MOUNTING HARDWARE INCLUDED*



**VK130003**  
KW - 13" - DROP VISOR - (W900 2007-2013) - (T660, T800 2007-2015)-  
CURVED WINDSHIELD

**VK131003**  
KW - 13" - DROP VISOR - W900 - T660 -  
CURVED WINDSHIELD - 2007 & NEWER  
- 1PC - BOLTLESS

# KENWORTH T660

## GANGSTER VISORS

MOUNTING HARDWARE INCLUDED

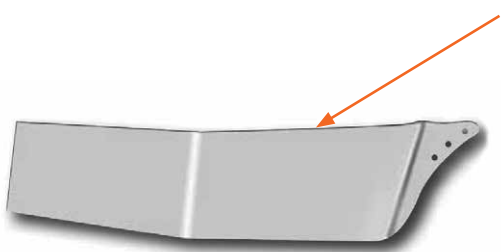

**VK132003**  
KW - 12" - GANGSTER VISOR -  
DROP - W900, T660, T800 - CURVED  
WINDSHIELD - 2007 & NEWER - 2 PC

**VK132003 - BF**  
KW - 12" - GANGSTER VISOR -  
DROP - W900, T660, T800 - CURVED  
WINDSHIELD - 2007 & NEWER - 2 PC



VK132003-BF

**ONLY AVAILABLE IN 12"**

## BOLTLESS WICKED VISORS

MOUNTING HARDWARE INCLUDED

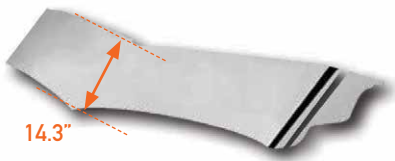

14.3"

**VK135003**  
KW - 14" - WICKED -  
DROP - W900, T660, T800  
- CURVED WINDSHIELD -  
2007 & NEWER - 2 PIECE

**COOL  
BOLTLESS  
LOOK!**



**VK136003**  
KW - 14" - WICKED  
GANGSTER - W900,  
T660, T800 - CURVED  
WINDSHIELD -  
2007-NEWER - 2 PIECE

YOU SAY  
**WICKED**  
LIKE IT'S A BAD THING

**KENWORTH T660**

**BATTERY & TOOL BOX COVERS**



**VK150008**  
T660 DAY CAB BATTERY BOX  
HIGHLIGHT





# KENWORTH T680



- 1** VK110028 Top of door trim – “lowered” look
- 2** VK110209 Cab Panel – Blank (VK110209-3GA shown)
- 3** VK150029 DEF Tank Cover
- 4** VK120101 Bug shield
- 5** VK130007 12” drop visor
- 6** FV-0010-708 Chrome front bumper (other options available)

# **KENWORTH T680**

## **CAB PANELS**

*MOUNTING HARDWARE INCLUDED*



**VK110209**

2015 T680 - CAB PANELS - BLANK"  
VERTICAL EXHAUST ONLY



**VK110210**

2016 T680 - CAB PANELS - BLANK



**VK110211**

2016 T680 - CAB PANELS - BLANK  
W/HEATER PLUG HOLE



**VK110210**

(ALTERNATE VIEW)

*BUILD A CUSTOM PANEL – SEE PAGES 92-93*

## **SLEEPER EXTENSION PANELS**

*MOUNTING HARDWARE INCLUDED*



**VK143001**

SLEEPER EXTENSION PANELS  
- T600, T800, W900 - BLANK -  
1992 - 2012

## **DOOR AND WINDOW TRIM**



**VK110222**

KW - T680 DOOR ENTRY KICK  
PANELS - 4PCS UPPER &  
LOWER

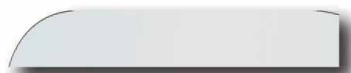

**VK110028**

KW T680 LOWERED LOOK - 2015



# **KENWORTH T680**

## **BUG SHIELDS**

MOUNTING HARDWARE INCLUDED



**VK120101**  
KW STAINLESS BUG SHIELD - T680

## **FENDER GUARDS**



**VK120018**  
KW - T680 FENDER GUARDS  
- FITTED - 4PCS. UPPER &  
LOWER

## **STAINLESS SUN VISOR**

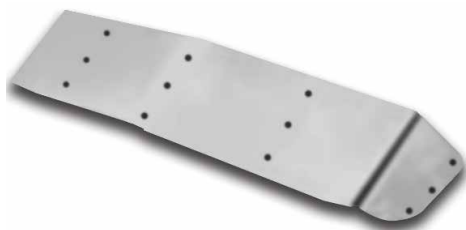

**VK130007**  
KW - 13" - DROP - T680, T880 -  
CURVED WINDSHIELD - 2015  
REPLACES FACTORY VISOR ONLY

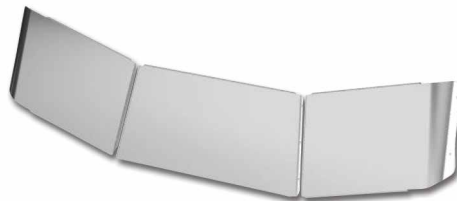

**VK130008**  
KW - 15" DROP VISOR T680  
MID-ROOF STANDUP SLEEPER  
WITH NO EXISTING FACTORY VISOR

# **KENWORTH T680**

## **DEF TANK COVER**



**VK150029**  
KW - UREA TANK COVER 2015  
T680



**W I N G M A S T E R**

**KENWORTH T800 & T880**





# KENWORTH T800 & T880

## SLEEPER PANELS

MOUNTING HARDWARE INCLUDED



**VK142035**

KW SLEEPER PANELS - T600  
(1995 & NEWER, NO FAIRINGS)  
T800 ( 1986 & NEWER ), W900  
(1986 & NEWER ) - 42" - BLANK



**VK142008**

KW SLEEPER PANELS -  
AEROCAB - NO SIDE FAIRING -  
T600, T800, W900 - 60" - BLANK  
- 1995 & NEWER



**VK142015**

KW SLEEPER PANELS -  
AEROCAB - NO SIDE FAIRING -  
T600, T800, W900 - 72" - BLANK



**VK142023**

KW SLEEPER PANELS -  
AEROCAB - NO SIDE FAIRING  
- T600, T800, W900 - 86" -  
BLANK

*BUILD A CUSTOM PANEL – SEE PAGES 92-93*



**EXAMPLE**  
VK142008-3UN



**EXAMPLE**  
VK142008-5RA



**EXAMPLE**  
VK142023-8GA

## SLEEPER EXTENSION PANELS

MOUNTING HARDWARE INCLUDED



**VK143001**

SLEEPER EXTENSION PANELS  
- T600, T800, W900 - BLANK -  
1992 - 2012



**EXAMPLE**  
VK143001-1GA

# **KENWORTH T800 & T880**

## **BUG SHIELDS**

MOUNTING HARDWARE INCLUDED



**VK120013**  
KW STAINLESS BUG SHIELD  
- T800

## **FENDER GUARDS**



**VK120022**  
KW - FENDER GUARDS - T-800  
AERO CAB -1996 & NEWER - PAIR

## **STAINLESS SUN VISORS**



**VK130003**  
KW - 13" - DROP VISOR - (W900 2007-2013) - (T660,  
T800 2007-2015)- CURVED WINDSHIELD  
MOUNTING HARDWARE INCLUDED



**VK130007**  
KW - 13" - DROP - T680, T880 -  
CURVED WINDSHIELD - 2015  
DAY CAB ONLY  
NO MOUNTING HARDWARE INCLUDED  
REPLACES FACTORY VISOR ONLY



VK130003

# KENWORTH T800 & T880

## GANGSTER VISORS

MOUNTING HARDWARE INCLUDED

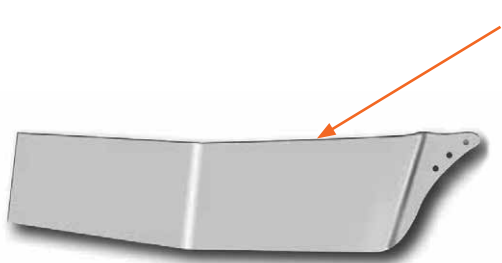

**VK132003**  
KW - 12" - GANGSTER VISOR -  
DROP - W900, T660, T800 - CURVED  
WINDSHIELD - 2007 & NEWER - 2 PC

**VK132003 - BF**  
KW - 12" - GANGSTER VISOR -  
DROP - W900, T660, T800 - CURVED  
WINDSHIELD - 2007 & NEWER - 2 PC



VK132003-BF

**ONLY AVAILABLE IN 12"**

## BOLTLESS WICKED VISORS

MOUNTING HARDWARE INCLUDED



**VK135003**  
KW - 14" - WICKED -  
DROP - W900, T660, T800  
- CURVED WINDSHIELD -  
2007 & NEWER - 2 PIECE

**COOL  
BOLTLESS  
LOOK!**



**VK136003**  
KW - 14" - WICKED  
GANGSTER - W900,  
T660, T800 - CURVED  
WINDSHIELD -  
2007-NEWER - 2 PIECE

YOU SAY  
**WICKED**  
LIKE IT'S A BAD THING

**BUILD A CUSTOM VISOR – SEE PAGES 92-93**



# **KENWORTH T800 & T880**

## **BATTERY & TOOL BOX COVERS**



**VK150004**  
KW - BATTERY BOX COVER -  
T600, T800, W900 - 39.5" X 9.0"



**VK150005**  
KW - BATTERY BOX COVER -  
T600, T800, W900 - 45" X 9"



**VK150006**  
KW - TOOL BOX COVER - T600,  
T800, W900 - 39.5" X 8.5"



**VK150007**  
KW - TOOL BOX COVER -  
T600, T800, W900 - 45" X 8.5"



## **ALL KENWORTH MODELS**

### **EXTERIOR WINDOW TRIM**

*MOUNTS WITH STRONG 3M DOUBLE-SIDED TAPE*



**VK110002**  
KW DAYLIGHT DOOR OUTER  
TRIM - 6PC



**VK110012**  
KW EXTERIOR WINDOW TRIM  
- PASSENGER DOOR VIEW -  
DAYLIGHT DOOR



**VK110013**  
KW EXTERIOR WINDOW TRIM  
PASSENGER DOOR VIEW

### **DOOR HANDLE TRIM**



**VK110003**  
PB, KW STAINLESS DOOR  
HANDLE TRIM - PAIR

### **LOWER LOOK**



**VK110017**  
KW WINDOW LOWERED LOOK 4.5"  
FITS DAYLIGHT DOOR ONLY

### **AIR DEFLECTORS**



**VK110001**  
T300 T600 T800 W900  
WINDOW AIR DEFLECTORS PAIR

**ALL KENWORTH MODELS**

**EMBLEM ACCENTS**

*KENWORTH LOGO NOT INCLUDED*



**VK100001**  
EMBLEM ACCENT  
OLD GLORY - PAIR  
TAPE MOUNT



**VK100002**  
EMBLEM ACCENT  
3 POINT SLOTTED - PAIR  
HARDWARE INCLUDED -PAIR



**VK100003**  
EMBLEM ACCENT  
FLAMES - PAIR  
TAPE MOUNT



**VK100004**  
EMBLEM ACCENT  
HIGH LIGHT - PAIR  
HARDWARE INCLUDED



**VK100005**  
EMBLEM ACCENT  
3 POINT - PAIR  
HARDWARE INCLUDED



**VK100006**  
EMBLEM ACCENT  
SATURN - PAIR  
HARDWARE INCLUDED



**VK100007**  
EMBLEM ACCENT  
SHORT SATURN - PAIR  
HARDWARE INCLUDED



**VK100008**  
EMBLEM ACCENT  
3-D LOOK - PAIR  
HARDWARE INCLUDED



**VK100009**  
EMBLEM ACCENT  
VICTORY LANE - PAIR  
HARDWARE INCLUDED



**VK100012**  
EMBLEM ACCENT  
U SHAPED UNDERLINE  
HARDWARE INCLUDED



**VK100015**  
EMBLEM ACCENT  
OVAL W/ UPWARD FLAME  
TAPE MOUNT

**HOOD LATCH GUARDS**



**VK100017**  
KW - HOOD LATCH GUARDS  
T222, T800, W900 1989 &  
NEWER - PAIR



**VK100018**  
KW - HOOD LATCH GUARDS  
ALL MODELS W/ BALL LATCH  
1968 -1989 - PAIR



**VU190011**  
PB, FL, KW, HOOD LATCH  
ACCENT TRIM - PAIR

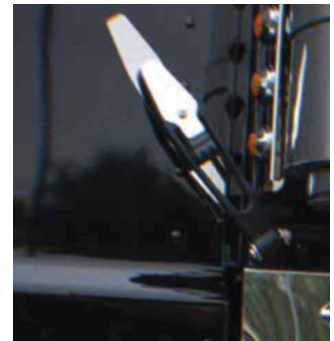

## **ALL KENWORTH MODELS**

### **SLEEPER WINDOW TRIM**



**VK140002**  
W9L SLEEPER  
WINDOW TRIM - PAIR



**VK140003**  
KW 72" SLEEPER  
UPPER WINDOW TRIM  
(SLIDING OR SWING) PAIR



**VK140004**  
KW 86" STUDIO SLEEPER UPPER  
SLIDING WINDOW TRIM PAIR

### **REAR FRAME COVERS**



**VK160001**  
KW - REAR FRAME COVER -  
1992 & NEWER



**VK160002**  
KW - REAR FRAME COVER -  
STEER HEAD - 1992 & NEWER

### **STAINLESS FUEL TANK WRAPS**



**VK150040**  
KW - 2014 FUEL TANK -  
HYDRAULIC TANK COMBO  
WRAP - 72"

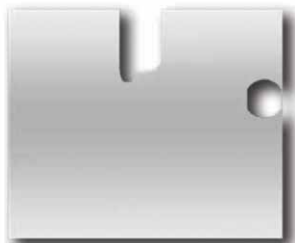

**VK150041**  
KW - 2014 FUEL TANK WRAP -  
75 GALLON - 57"



# FREIGHTLINER FLD/CLASSIC



# **FREIGHTLINER FLD / CLASSIC**

## **CAB PANELS 4"**

*MOUNTING HARDWARE INCLUDED*



**VF110015**  
FL - CAB PANEL - BLANK -  
PAIR - 1991 NEWER CLASSIC

*BUILD A CUSTOM PANEL - SEE PAGES 92-93*



**EXAMPLE**  
VF110015-3UN



**EXAMPLE**  
VF110015-4GA

## **SLEEPER PANELS**

*MOUNTING HARDWARE INCLUDED*



**VF142003**  
2001 CLASSIC XL INTEGRAL SLEEPER NO AERO  
WINGS - 48" SLEEPER PANELS - PAIR- BLANK



# **FREIGHTLINER FLD / CLASSIC**

## **HOOD LATCH GUARDS**



**VF100001**  
FL - HOOD LATCH GUARDS -  
CLASSIC 1993 & NEWER - PAIR



**VF100005**  
FL - HOOD LATCH GUARDS -  
CLASSIC X L -  
1993 & NEWER - PAIR



**VU190011**  
PB, FL, KW, HOOD LATCH  
ACCENT TRIM - PAIR

## **HOOD TRIM**



**VF100010**  
FL CLASSIC FRONT SIDE OF HOOD  
TRIM W/ FLAMES PAIR



**VF100011**  
FL - LOWER HOOD PANELS -  
CLASSIC X L - 1993 & NEWER -  
PAIR

## **LOWERED LOOK WINDOW PANELS**



**VF110018**  
FLD & CLASSIC 5.75" LOWERED  
LOOK WINDOW PANELS

## **FREIGHTLINER FLD / CLASSIC**

### **MISC. TRIM PIECES**



**VF110013**  
FL - DOOR LATCH TRIM -  
CENTURY / COLUMBIA /  
CLASSIC FLD - PAIR



**VF114001**  
FREIGHTLINER CLASSIC - HOOD  
EXTENSION PANEL - LAY-OVER - PAIR

### **AIR CLEANER LIGHT BOXES**



**VF112001**  
FL - CLASSIC - FRONT - AIR  
CLEANER LIGHT BOXES -  
BLANK - PAIR



**VF113001**  
FL - CLASSIC - REAR - AIR  
CLEANER LIGHT BOXES -  
BLANK - PAIR

*BUILD A CUSTOM LIGHT BOX – SEE PAGES 92-93*

# FREIGHTLINER FLD / CLASSIC

## FENDER GUARDS



**VF120003**  
FL CLASSIC & X L UPPER  
FENDER GUARDS (SHORT &  
LONG HOOD) PAIR



**VF120004**  
FL - FENDER GUARDS -  
EXTENDED HOOD - CLASSIC  
- 1993 & NEWER - PAIR

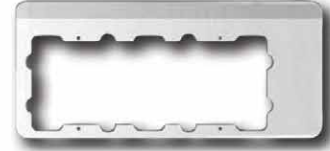

**VF120007**  
FL - FENDER GUARDS - FLD  
120 - 1989 & NEWER

## HEADLIGHT VISORS



**VU190009**  
HEAD LIGHT VISOR -  
DOUBLE -PB, KW, FL



**VU190010**  
HEAD LIGHT VISOR -  
SINGLE - PB, KW, FL

## STAINLESS TRIM FOR PLASTIC BUMPERS



**VF120001**  
FLD SETBACK AXLE  
BUMPER TRIM KIT  
W/ 1 TOW PIN & FOG LIGHT  
HOLES 3 PC

ALSO CHECK OUT OUR  
EXTENSIVE LINE OF FULL METAL  
REPLACEMENT BUMPERS:  
CLASSIC, PAGES 11-13  
FLD SETBACKS, PAGES 15-19



# **FREIGHTLINER FLD / CLASSIC**

## **BUG SHIELDS**

RUBBER TRIM & MOUNTING HARDWARE INCLUDED



**VF120010**  
FL - BUG SHIELD - STAINLESS  
- CLASSIC & CLASSIC XL



**VF120011**  
FL - BUG SHIELD - STAINLESS  
- FLD 120



**W I N G M A S T E R**

# FREIGHTLINER FLD / CLASSIC

## SUN VISORS

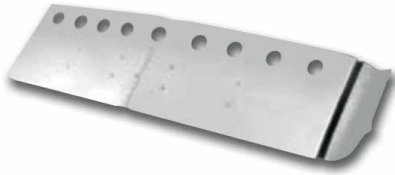

**VF130001**  
FL - 18" DROP VISOR - CLASSIC RAISED  
ROOF CONDO - 9 - 2" RD - NO LIGHTS

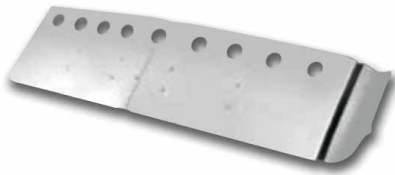

**VF130002**  
FL - 18" DROP VISOR - CLASSIC MID ROOF -  
9 - 2" RD - NO LIGHTS



**VF130006**  
FL-13" - DROP VISOR - CLASSIC XL FLAT  
TOP - REPLACES FACTORY STAINLESS -  
NOT FIBERGLASS OR NO VISOR

**PAINTABLE  
VISORS  
AVAILABLE**

JUST ADD "P" TO THE END  
FOR PAINTABLE. EXAMPLE:

**VF130001P**  
RAW 18 GAUGE STEEL

**BUILD A CUSTOM VISOR – SEE PAGES 92-93**



**W I N G M A S T E R**

# **FREIGHTLINER FLD / CLASSIC**

## **WICKED BOLTLESS VISORS**

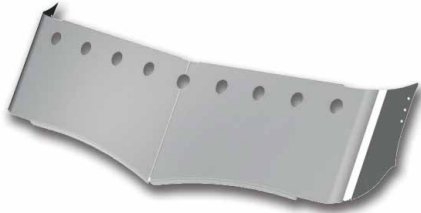

**VF135001**  
FL - 18" - WICKED - DROP  
VISOR - CLASSIC RAISED  
ROOF CONDO - 9 - 2" RD -NO  
LIGHTS - 2 PC



**VF135002**  
FL - 18" - WICKED - DROP  
VISOR - CLASSIC MID-ROOF -  
9 - 2" RD - NO LIGHTS - 2 PC



**VF135006**  
FL - 13" - WICKED - DROP  
VISOR - CLASSIC XL - FLAT  
TOP UP TO 2001 W/SS  
FACTORY VISOR - 2 PC

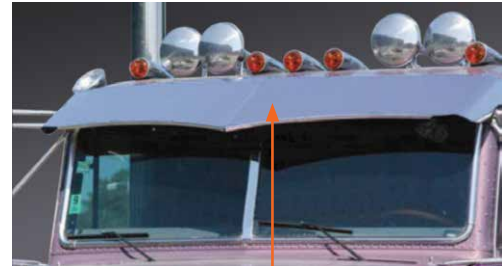

VF135006

YOU SAY  
**WICKED**  
LIKE IT'S A BAD THING

**COOL  
BOLTLESS  
LOOK!**

**BUILD A CUSTOM VISOR – SEE PAGES 92-93**



**W I N G M A S T E R**



**FREIGHTLINER CENTURY & COLUMBIA**



# FREIGHTLINER CENTURY & COLUMBIA

## CAB PANELS 4"

MOUNTING HARDWARE INCLUDED

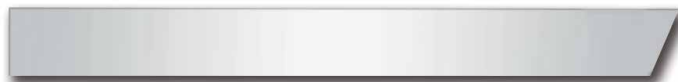

**VF110020**

FL - CAB PANEL - 4" - 2005  
AND NEWER CENTURY/COLUMBIA

BUILD A CUSTOM PANEL - SEE PAGES 92-93

## SLEEPER PANELS



**VF140020**

2005 AND NEWER CENTURY/  
COLUMBIA SLEEPER PANEL +  
EXTENSION - 1PC - 70" - BLANK

## MISC. TRIM PIECES

MOUNTS WITH STRONG 3M DOUBLE-SIDED TAPE



**VF110013**

FL- DOOR LATCH TRIM -  
CENTURY / COLUMBIA /  
CLASSIC FLD - PAIR



**VF110014**

FL - VIEW WINDOW TRIM RING  
- CENTURY / COLUMBIA



**VF110019**

FL - CENTURY / COLUMBIA UPPER CAB  
HIGHLIGHT - 2PCS

# FREIGHTLINER CENTURY & COLUMBIA

## STAINLESS TRIM FOR PLASTIC BUMPERS



**VF120002**  
FL CENTURY FT BUMPER TRIM  
03-OLDER - 3 PC  
TAPE MOUNT

ALSO CHECK OUT OUR  
EXTENSIVE LINE OF FULL METAL  
REPLACEMENT BUMPERS:  
CENTURY, PAGES 20-21  
COLUMBIA, PAGES 19-20



## BUG SHIELDS

RUBBER TRIM & MOUNTING HARDWARE INCLUDED



**VF120013**  
FL - BUG SHIELD - STAINLESS  
- CENTURY



**VF120014**  
FL - BUG SHIELD - STAINLESS  
- COLUMBIA



**FREIGHTLINER CENTURY & COLUMBIA**

**SUN VISORS**

BRACKETS AND MOUNTING HARDWARE INCLUDED  
AVAILABLE IN 304 STAINLESS STEEL – CALL FOR PRICING



**VF130003**  
FL-18" - DROP VISOR - RAISED ROOF  
CENTURY - 2003 & OLDER - 10 - 2" RD -  
HOLES - NO LIGHTS ALSO FITS 2009 &  
OLDER CORONADO



**VF130007**  
FL-18" DROP VISOR - RAISED ROOF CENTURY  
& COLUMBIA - 2004 & NEWER - 10 - 2" RD  
HOLES - NO LIGHTS



**VF130014**  
FL - 14" DROP VISOR - 04  
CORONADO DAY CAB 06 -  
NEWER & COLUMBIA- NO LIGHTS  
WORKS FOR TRUCKS WITHOUT EXISTING FACTORY VISOR



**VF130016**  
FL - 16" DROP VISOR - 04  
CENTURY/05 COLUMBIA MID  
ROOF - NO LIGHTS

**PAINTABLE  
VISORS  
AVAILABLE**

JUST ADD "P" TO THE END  
FOR PAINTABLE. EXAMPLE:

**VF130003P**  
RAW 18 GAUGE STEEL

**BUILD A CUSTOM VISOR – SEE PAGES 92-93**

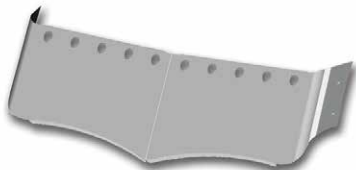

**VF135003**  
FL - 18" - WICKED - DROP  
VISOR - CENTURY-RAISED  
ROOF - UP TO 2003 - 2 PC

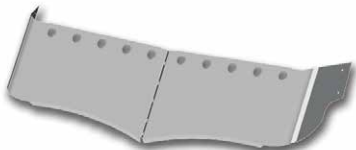

**VF135007**  
FL- 18" - WICKED - DROP VISOR  
- CENTURY & COLUMBIA 2004 -  
NEWER - 2 PC - 10 2" RD HOLES  
NO LIGHTS



**VF135016**  
FL - 16" WICKED - DROP VISOR -  
04 CENTURY/05 COLUMBIA MID  
ROOF - NO LIGHTS

YOU SAY  
**WICKED**  
LIKE IT'S A BAD THING

**COOL  
BOLTLESS  
LOOK!**



**FREIGHTLINER CORONADO 2002-2009  
& GLIDER KITS**



**FREIGHTLINER CORONADO 2002-2009/GLIDERS**

**BUG SHIELDS**

RUBBER TRIM & MOUNTING HARDWARE INCLUDED



**VF120012**  
FL - BUG SHIELD - STAINLESS  
- CORONADO



**SUN VISORS**

BRACKETS AND MOUNTING HARDWARE INCLUDED  
AVAILABLE IN 304 STAINLESS STEEL – CALL FOR PRICING

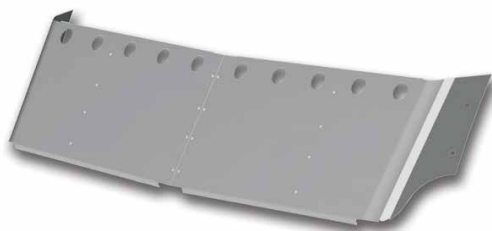

**VF130003**  
FL-18" - DROP VISOR - RAISED ROOF  
CENTURY - 2003 & OLDER - 10 - 2" RD -  
HOLES - NO LIGHTS ALSO FITS 2009 &  
OLDER CORONADO



**VF130014**  
FL - 14" DROP VISOR - 04  
CORONADO DAY CAB 06 -  
NEWER & COLUMBIA- NO LIGHTS

**BUILD A CUSTOM VISOR – SEE PAGES 92-93**



**FREIGHTLINER CASCADIA 2017  
& OLDER "P3"**



# **FREIGHTLINER CASCADIA 2017 & OLDER**

## **CAB PANELS 4"**

*MOUNTING HARDWARE INCLUDED*

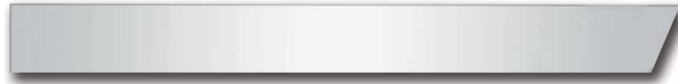

**VF110200**  
CAB PANEL 4" - CASCADIA -  
BLANK PAIR



VF110200

*BUILD A CUSTOM PANEL – SEE PAGES 92-93*

## **SLEEPER PANELS**

*MOUNTING HARDWARE INCLUDED*



**VF140010**  
CASCADIA SLEEPER PANEL 48"



**VF142101**  
FL SLEEPER EXTENSION PANEL -  
CASCADIA - 48" - BLANK



VF140012

VF140010

# FREIGHTLINER CASCADIA 2017 & OLDER

## FAIRING PANELS

MOUNTS WITH STRONG 3M DOUBLE-SIDED TAPE

MID FAIRING KIT:



**VF142009**  
2008 CASCADIA MID FAIRING  
PANELS - 6 PCS - BLANK

LOWER FAIRING KIT:



**VF142012**  
2008 CASCADIA LOWER FAIRING  
PANELS - 6 PCS - BLANK

UNDER FAIRING KIT:



**VF142014**  
2008 CASCADIA MID FAIRING  
PANELS - 6 PCS - BLANK

UNDER FAIRING INDIVIDUAL PIECES:



**VF142014-1**  
2008 CASCADIA UNDER  
FAIRING PANEL - FRONT  
PASS SIDE



**VF142014-2**  
2008 CASCADIA UNDER  
FAIRING PANEL - MIDDLE  
PASS SIDE



**VF142014-3**  
2008 CASCADIA UNDER  
FAIRING PANEL - REAR  
PASS SIDE



**VF142014-4**  
2008 CASCADIA UNDER  
FAIRING PANEL - FRONT  
DRIVERS SIDE



**VF142014-5**  
2008 CASCADIA UNDER  
FAIRING PANEL - MIDDLE  
DRIVERS SIDE



**VF142014-6**  
2008 CASCADIA UNDER  
FAIRING PANEL - REAR  
DRIVERS SIDE



Mid Fairing

Lower Fairing

Under Fairing

# FREIGHTLINER CASCADIA 2017 & OLDER

## FENDER TRIM

MOUNTS WITH STRONG 3M DOUBLE-SIDED TAPE



**VF100012**

FL - CASCADIA FENDER TRIM - 2PC



**VF100013**

FL - CASCADIA FENDER TRIM EXT. - 2PC

## HOOD & DOOR TRIM

MOUNTS WITH STRONG 3M DOUBLE-SIDED TAPE



**VF100016**

FL - HOOD LIGHT TRIM - PAIR



**VF100015**

FL - CASCADIA AIR VENT ACCENT



**VF110016**

CASCADIA DOOR  
HANDLE TRIM

## LOWERED LOOK WINDOW PANELS



**VF110017**

CASCADIA LOWERED LOOK  
WINDOW PANELS

ALSO FITS 2018 & NEWER P4 MODEL CASCADIAS



# FREIGHTLINER CASCADIA 2017 & OLDER

## STAINLESS TRIM FOR PLASTIC BUMPERS



**VF120017**  
CASCADIA FENDER TRIM -  
ABOVE BUMPER - PAIR



**VF120006**  
CASCADIA FT BUMPER TRIM  
- 4PC - TAPE MOUNT



VF120017

VF120006

ALSO CHECK OUT OUR EXTENSIVE  
LINE OF FULL METAL CASCADIA  
REPLACEMENT BUMPERS:  
PAGE 22



## BUG SHIELDS

RUBBER TRIM & MOUNTING HARDWARE INCLUDED



**VF120015**  
FL - BUG SHIELD - STAINLESS  
- CASCADIA



# FREIGHTLINER CASCADIA 2017 & OLDER

## SUN VISORS

BRACKETS AND MOUNTING HARDWARE INCLUDED  
AVAILABLE IN 304 STAINLESS STEEL – CALL FOR PRICING

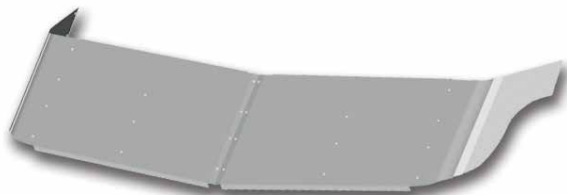

**VF130008**  
FL - 17" DROP VISOR - CASCADIA REPLACES  
FACTORY VISOR  
FITS CASCADIA "P3" YRS. 2017 & OLDER  
FITS CASCADIA "P4" YRS. 2018 & NEWER



**PAINTABLE  
VISORS  
AVAILABLE**

JUST ADD "P" TO THE END  
FOR PAINTABLE. EXAMPLE:

**VF130008-P**  
RAW 18 GAUGE STEEL

### BUILD A CUSTOM VISOR – SEE PAGES 92-93



**VF135008**  
FL - 18" - WICKED - DROP VISOR  
- CASCADIA - 2 PC - CASCADIA  
REPLACES FACTORY VISOR  
FITS CASCADIA "P3" YRS. 2017 & OLDER  
FITS CASCADIA "P4" YRS. 2018 & NEWER

YOU SAY  
**WICKED**  
LIKE IT'S A BAD THING

**COOL  
BOLTLESS  
LOOK!**



# **FREIGHTLINER CASCADIA 2017 & OLDER**

## **FUEL TANK COVERS**

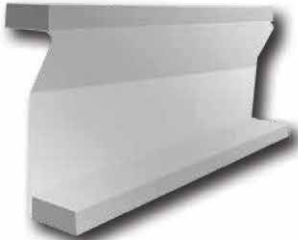

**VF150006**  
FL - CASCADIA FUEL TANK  
COVER W/STEPS - PASS SIDE

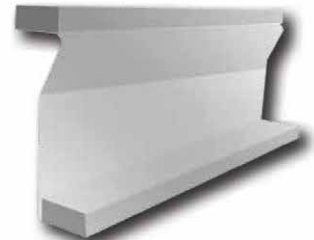
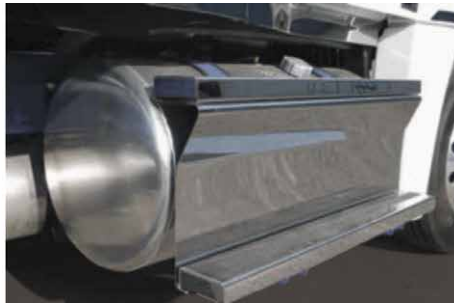

**VF150007**  
FL - CASCADIA BATTERY BOX/  
FUEL TANK COVER - 2011 DAY  
CAB 34"

## **BATTERY BOX COVERS & STEPS**

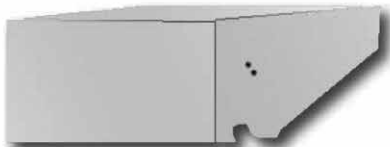

**VF150000**  
FL - CASCADIA BATTERY  
BOX COVER



**VF150005**  
FL - CASCADIA UNDER  
BATTERY BOX STEP- 3PC.



**VF150010**  
FL - CASCADIA BATTERY BOX  
UPPER - 2011 DAY CAB 34"



**VF150011**  
FL - CASCADIA BATTERY BOX  
UPPER - 2011 DAY CAB 40"

## **CATALYTIC COVERS**

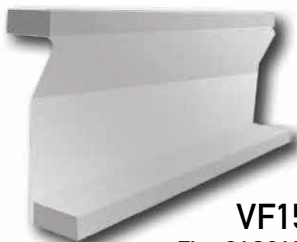

**VF150008**  
FL - CASCADIA CATALYTIC  
COVER - LOWER 2011 DAY  
CAB 40"

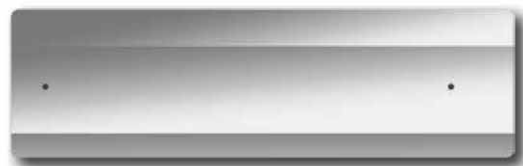

**VF150009**  
FL - CASCADIA CATALYTIC  
COVER - UPPER 2011 DAY CAB  
40"

# FREIGHTLINER ACCESSORIES - ALL MODELS

## EMBLEM ACCENTS



**VF100002**  
FL - EMBLEM ACCENTS -  
W/ CUTOUTS - PAIR  
INCLUDES MOUNTING HARDWARE



**VF100004**  
FL - EMBLEM ACCENTS -  
16" - PAIR  
TAPE MOUNT

## PERMIT PANELS



**VF110007**  
FL - PERMIT PANEL - EMBLEM  
& CUTOUT - LEFT -  
1998 & NEWER



**VF110008**  
FL - PERMIT PANEL - PLUG  
CUTOUT - LEFT -  
1998 & NEWER



**VF110009**  
FL - PERMIT PANEL - EMBLEM  
CUTOUT - LEFT -  
1998 & NEWER



**VF110010**  
FL - PERMIT PANEL - BLANK -  
LEFT - 1998 & NEWER



**VF110011**  
FL - PERMIT PANEL - EMBLEM  
CUTOUT - RIGHT -  
1998 & NEWER



**VF110012**  
FL - PERMIT PANEL - BLANK -  
RIGHT - 1998 & NEWER

## FUEL TANK FAIRING

BRACKETS AND MOUNTING HARDWARE INCLUDED  
NOT AVAILABLE IN 430 STAINLESS



**VF150001**  
FL - FUEL TANK FAIRINGS -  
82" - PAIR



**VF150002**  
FL - FUEL TANK FAIRINGS -  
87" - PAIR



**VOLVO VNL**



# **VOLVO VNL**

## **HOOD & FENDER TRIM**



**VV120002**  
FENDER GUARD - UPPER -  
780 SERIES  
TAPE MOUNT

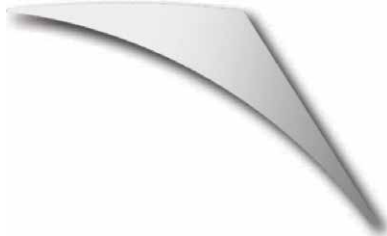

**VV100003**  
FENDER GUARD - UPPER -  
780 SERIES  
TAPE MOUNT



## **BUG SHIELD**

*MOUNTING HARDWARE INCLUDED*



**VV120107**  
BUG DEFLECTOR 630, 670, 780,  
830, 880 SERIES



## **STAINLESS TRIM FOR FACTORY VISORS**



**VV130000**  
VISOR INSERT - 700, 800  
SERIES





# VOLVO VNL

## FAIRING HIGHLIGHTS

MOUNTS WITH STRONG 3M DOUBLE-SIDED TAPE



**VV121000**  
FRONT FAIRING UPPER  
STEP PANEL - PAIR



**VV121001**  
FRONT FAIRING UPPER  
STEP HIGHLIGHT  
2PCS



**VV121002**  
FRONT FAIRING LOWER  
STEP PANEL - PAIR



**VV121003**  
FRONT FAIRING LOWER  
STEP HIGHLIGHT



**VV121004**  
FRONT FAIRING LOWER  
STEP BOTTOM HIGHLIGHT



**VV121005**  
REAR FAIRING UPPER  
STEP HIGHLIGHT



**VV121006**  
REAR FAIRING LOWER  
STEP PANEL



**VV121007**  
REAR FAIRING LOWER  
STEP HIGHLIGHT



**VV121008**  
REAR FAIRING LOWER  
STEP BOTTOM HIGHLIGHT



**VOLVO**

**WINGMASTER ACCESSORIES**

# **VOLVO VT SERIES**





# VOLVO VT SERIES

## CAB PANELS

MOUNTING HARDWARE INCLUDED



VV112000  
CAB PANELS 880/830 - BLANK  
- NO SIDE FAIRING



EXAMPLE  
VV112000-4GA

BUILD A CUSTOM PANEL – SEE PAGES 92-93

## SLEEPER PANELS

MOUNTING HARDWARE INCLUDED



VV143000  
SLEEPER PANELS - BLANK -  
WITH NO SIDE FAIRINGS



EXAMPLE  
VV143000 - 5UN



EXAMPLE  
VV143000- 5RN



EXAMPLE  
VV143000 - 7RA



EXAMPLE  
VV143000 - 4GA

# **VOLVO VT SERIES**

## **HOOD EXTENSION PANELS**

*MOUNTING HARDWARE INCLUDED*



**VV110300**  
HOOD EXTENSION PANEL  
- BLANK



**EXAMPLE**  
VV110300-4GA

*BUILD A CUSTOM PANEL – SEE PAGES 92-93*

## **HOOD & FENDER TRIM**



**VV100000**  
HEADLIGHT TRIM - SIDE -  
830, 880 SERIES  
TAPE MOUNT



**VV100001**  
TOP FENDER TRIM - 830,  
880 SERIES  
TAPE MOUNT



## **VOLVO VT SERIES**

### **HOOD & FENDER TRIM**

*MOUNTS WITH STRONG 3M DOUBLE-SIDED TAPE*



**VV120000**  
FENDER GUARD - UPPER -  
830, 880 SERIES



**VV120001**  
FENDER GUARD - LOWER -  
830, 880 SERIES

### **BUG SHIELD**

*MOUNTING HARDWARE INCLUDED*



**VV120107**  
BUG DEFLECTOR 630, 670, 780,  
830, 880 SERIES



### **SUN VISORS**

*MOUNTING HARDWARE INCLUDED*

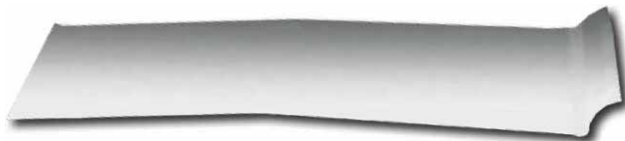

**VV130005**  
DROP VISOR - 830 MID-ROOF



# **VOLVO VT SERIES**

## **BATTERY BOX COVER**



**VV150000**  
BATTERY BOX COVER - 830  
VOLVO - 8PCS



## **FUEL TANK FAIRINGS**



**VV150001**  
FUEL TANK FAIRINGS - 68"





WESTERN STAR 4700SF

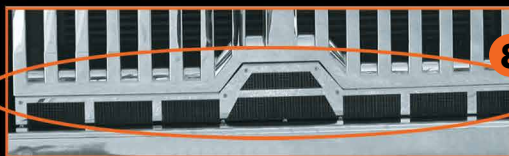

**PARTS LIST:**

- 1 IM-2110-06** Chrome Bumper (Call for Options & Price)
- 2 VW120005** Fender Guards (Fitted)
- 3 VW120006** Upper Fender Guards (Rolled)
- 4 VW110200-8GMA** Cab Panel Line  
(Cab Panels with Granite Amber Lights Shown)
- VW110200** Blank Cab Panels w/Heater Plug Holes (Not Pictured)
- VW110201** Blank Cab Panels (Not Pictured)
- 5 VW130001** 12" Visor - 2013 & Newer
- 6 VW120010** Bug Shield - Stainless Steel
- 7 VW120011** Bug Shield - Stainless Steel - "W" Look
- 8 VW120201** Lower Radiator Rock Guard

**WESTERN STAR 4700SF YEARS 2013 & NEWER**

**CAB PANELS**

MOUNTING HARDWARE INCLUDED



**VW110200**  
WS CAB PANELS - 2013 AND  
NEWER - 4700 SF - BLANK W/  
HEATER PLUG HOLE



**VW110201**  
CAB PANELS - BLANK - NO  
SIDE FAIRING - 4PCS

*BUILD A CUSTOM PANEL – SEE PAGES 92-93*

**FENDER GUARDS**



**VW120005**  
WS FENDER GUARDS - FITTED -  
4700 SF 2013 AND NEWER  
HARDWARE INCLUDED

**VW120006**  
WS UPPER FENDER GUARD  
- FITTED 4700 SF 2013  
AND NEWER  
TAPE MOUNT





# **WESTERN STAR 4700SF YEARS 2013 & NEWER**

## **BUG SHIELDS**

*BRACKETS & MOUNTING HARDWARE INCLUDED*



**VW120010**  
PB BUG SHIELD - STAINLESS  
- 4700 SF 2013 AND NEWER



**VW120011**  
WS BUG SHIELD - "W" STYLE  
- STAINLESS - 4700 SF 2013  
AND NEWER

## **RADIATOR ROCK GUARD**



**VW120201**  
WS LOWER RADIATOR  
GUARD - 2013 AND NEWER  
4700 SF

## **SUN VISORS**

*BRACKETS & MOUNTING HARDWARE INCLUDED*



**VW130001**  
WS 12" VISOR 2013 AND NEWER  
4700 SF



**5700XE YEARS 2015 & NEWER**

**SUN VISORS**

*BRACKETS & MOUNTING HARDWARE INCLUDED*

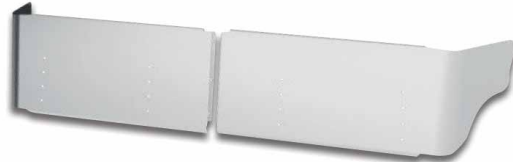

**VW130002**  
WS SUNVISOR  
5700XE STAINLESS

*ADD LIGHTS TO BUILD A CUSTOM VISOR – SEE PAGES 92-93*



*For more info on bumpers for this model, see page 73*

**BUG SHIELDS**

*MOUNTING HARDWARE INCLUDED*



**VW120014**  
WS BUGSHIELD  
5700XE STAINLESS

**THE ORIGINAL  
TURBOWING**

**BY**

**WINGMASTER**

**A DIVISION OF VALLEY CHROME PLATING**





## THE TURBOWING ADVANTAGE

"The Original Turbowing" is the Grand-Daddy of all air deflectors. This size, shape and design is today's air deflector of choice and will be for another 30 years. Impeccable over the road performance records make it one of the most popular accessories in the industry today, because Turbowing works. Proven efficiency saves truckers thousands of dollars in fuel costs each year. Get started today!

### DURABILITY:

Turbowing "Tough" is the term unmatched in the trucking industry today. A rugged over-the-road environment remains a real-life "Tell-tale" test for big rig accessories. Some air deflectors are giving in to this harsh reality, Turbowings remain solid and continue to prove their worth, trip after trip!

### FUNCTIONAL:

Testimonials from owner operators have shown consistent fuel savings of approximately **10% up to 19%**. for the average owner/operator, this means payback for their Turbowing investment in less than six months.

## EXAMINE THIS LIST OF FEATURES OFFERED ONLY BY WINGMASTER COMPANY:

- Highest quality materials and hardware.
- Pre-formed body panels to reduce undue stress on rivets.
- Sleeper specific brackets attach to the strongest points of the sleeper at the factory-built supports.
- Fixed angle brackets ensure the correct angle for deflection of air, no fooling around.
- Full application range to fit all popular sleeper sizes in flat-top and raised roofs.
- Paccar approved, one of the only wing-styled air deflectors available through Paccar's parts division.
- Tested and proven so you gain every time.

## PICKUP TRUCK WINGS

### HIGHLIGHTS OF THE WINGMASTER LINE OF AIR DEFLECTORS

- 30% reduction in drag.
- Wings are available in mirror polished stainless steel.
- Reduced "bug splatter" on the front of the trailer.
- Enhances stability in windy situations.
- Increased towing speed.
- The ability to pass other large vehicles without getting bogged down or blown around from on-coming wind.
- No drilling required with easy on and off clip mount system. (For most full size domestic pickup trucks 3/4 ton and up)

### DESIGNED TO IMPROVE YOUR TOW PACKAGE

Towing a 5th wheel trailer, gooseneck race car trailer with a pickup truck or big rig semi truck means you are fighting the wind. Wingmaster builds a stylish wing to deflect air over the trailer and maximize fuel economy every time you tow.

Going camping? Want to get better fuel mileage towing on the way to and from your destination but just want the most economical way to save fuel? Use Wingmaster air deflectors.

### TURBOWING UNIVERSAL CLIP-ON/BOLT-ON WING

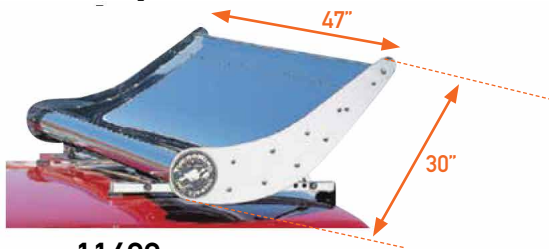

**11600**

DODGE, CHEVY, FORD - POWER  
\*SEE UNIVERSAL MOUNTING KITS

### HIGH PROFILE UPGRADE KIT



**11603**

11600 UPGRADE KIT, MINI WING,  
END PLATES, BOLT KITS

APPLICATION	CAB STYLE	CLIP-ON KIT	BOLT-ON KIT
2001 - 2006 Chevy & GMC (2500-3500)	Extended w/4-door	10244	11703
2001 - 2006 Chevy & GMC (2500-3500)	Extended w/ small door	10244	11703
2001 - 2006 Chevy & GMC (2500-3500)	Crew cab	10249	11704
2007 & Newer Chevy & GMC (2500-3500)	Extended cab	17249	11703
2007 & Newer Chevy & GMC (2500-3500)	Crew cab	17249	11704
2010-2014 Chevy	Crew cab	10258	(N/A)
2015 Chevy	Crew cab	10256	(N/A)
1980 -1997 Ford	All cabs w/rain gutters	11230	CALL
1998 & Newer Ford Standard,	Extended w/4-door, Crew	10237	10601
2015 Ford 3/4 ton to 1 ton	Super Crew	10257	(N/A)
1994-2002 Dodge (1500-3500)	All cabs	10251	(N/A)
2003-2010 Dodge	All cabs	10252	11706
2013 & Newer Dodge	All cabs	10254	(N/A)



## AEROLIGHT 700 SERIES



- 38" Rail
- 76"L X 26"D X 20"H
- Ideal size and function for all stand-up high-roof sleepers
- Downsized, identical design/function as the Turbowing 1.
- Conforms to industry height restrictions.
- Preset wing angle for optimum performance.
- Polished stainless bracketry.
- Polished stainless available for most standups.



## 900 SERIES

The Turbowing 900 Series was originally developed for the lower roof flat-top style sleepers where the height of the trailer was significantly taller than the roof of the truck. This design boasts bold, sharp looks, and works extremely well at increasing fuel mileage.

### Standard 900 Series

- Weight 125 lbs.
- 76"L X 30"D X 30"H
- Wing body: mirror polished stainless
- Brackets: polished stainless steel
- Adjustment: preset per sleeper/trailer height
- Fuel mileage increase: approx. 10%
- Drag/wing resistance reduction: 30%
- For most flat-top sleepers
- Warranty: 3 year limited





**PETERBILT WINGS**



**711**  
HIGH ROOF/STANDUP SLEEPERS



**911**  
FLAT TOP/ C/O CABOVER

**MOUNTING KITS**

**AEROLIGHT 700 - PETERBILT**

**48700**  
48" HR - HIGH ROOF/  
STANDUP SLEEPER

**63700**  
63"/72" HR - HIGH ROOF/  
STANDUP SLEEPER

**70700**  
70" HR - HIGH ROOF/STANDARD OR  
UNIBILT SLEEPER

**AEROLIGHT 900 - PETERBILT**

**63900**  
63"/72" STD FT - STANDARD  
FLATTOP NON-UNIBILT

**50900**  
48" STD FT - STANDARD  
NON-UNIBILT

**36900**  
36" STD FT - STANDARD  
NON-UNIBILT

**63900U**  
63"/72" STD FT - STANDARD  
FLATTOP UNIBILT

**90900**  
90" C/O CAB OVER

**HOOD WINGS**



**11131**  
HOOD WINGS - POWER STYLE -  
UNIVERSAL (EXCEPT KW) 42X9X6

**KENWORTH WINGS**



**711**  
ALL HIGH ROOF SLEEPERS



**911**  
AEROCAB INTEGRAL/ STANDARD  
FLATTOP/ CAB OVERS

**MOUNTING KITS**

**AEROLIGHT 700 - KENWORTH**

**KW700**

ALL HR - HIGH ROOF SLEEPERS  
60", 62", 72", 74", & 86" AERODYNE I, II, STUDIO SLEEPERS & STAND UP AEROCAB

**AEROLIGHT 900 - KENWORTH**

**62900**  
62" ING - AEROCAB  
INTEGRAL FLATTOP

**60900**  
60" STD FT -  
STANDARD FLATTOP

**42900**  
42" STD FT -  
STANDARD FLATTOP

**72900**  
72" ING - AEROCAB  
INTEGRAL FLATTOP

**49900**  
50" STD FT -  
STANDARD FLATTOP

**37900**  
36" STD FT -  
STANDARD FLATTOP

**HOOD WINGS**



**11151**  
HOOD WINGS POWER STYLE

**FREIGHTLINER WINGS**



**711**  
HI-STYLE/STANDARD RAISED  
ROOF/MID ROOF INTEGRAL



**911**  
STANDARD INTEGRAL/STANDARD  
FLATTOP/CAB OVER

**MOUNTING KITS**

**AEROLIGHT 700 - FREIGHTLINER**

**FX711**

BUSINESS CLASS FL50, FL60, FL70, FL80, FL106, FL112, M2(72") WING & BRKTS SOLD TOGETHER

**56700**

58" MR ING - MID ROOF INTEGRAL

**69700**

70" MR ING - MID ROOF INTEGRAL

**TURBOWING 900 - FREIGHTLINER**

**70900**

70" ING - STANDARD INTEGRAL  
SLEEPER CAB

**47900**

48" ING - STANDARD INTEGRAL  
SLEEPER CAB

**49900**

50" STD FT - STANDARD FLATTOP  
SLEEPER BOX

**57900**

58" ING - STANDARD INTEGRAL  
SLEEPER CAB

**58900**

60" STD FT - STANDARD FLATTOP  
SLEEPER BOX

**39900**

40" STD FT - STANDARD FLATTOP  
SLEEPER BOX

**86900**

86" C/O - CAB OVER

**HOOD WINGS**



**11131**

HOOD WINGS - POWER STYLE -  
UNIVERSAL (EXCEPT KW) 42X9X6

**INTERNATIONAL WINGS**



**711**  
HIGH ROOF/STANDUP SLEEPERS



**911**  
FLAT TOP/ C/O CABOVER

**MOUNTING KITS**

**51700**  
51" H/R - HI-RISE INTEGRAL  
PRO SLEEPER

**72700**  
72" H/R - HI-RISE INTEGRAL  
PRO SLEEPER

**TURBOWING 900 - INTERNATIONAL**

**73900**  
72" ING - LO-ROOF INTEGRAL  
PRO SLEEPER

**59900**  
60" STD FT -  
STANDARD FLATTOP

**41900**  
42" STD FT -  
STANDARD FLATTOP

**51900**  
51" ING - LO-ROOF  
INTEGRAL PRO SLEEPER

**48900**  
48" STD FT -  
STANDARD FLATTOP

**86900**  
86" C/O - CAB OVER

**10900**  
110" C/O - CAB OVER

**HOOD WINGS**



**11131**  
HOOD WINGS - POWER STYLE -  
UNIVERSAL (EXCEPT KW) 42X9X6

**WESTERN STAR WINGS**



**AEROLIGHT 700 - WESTERN STAR**

WESTERN STAR WINGS HAVE DIFFERENT C-C DIM. 60" SOLID WING & MOUNTING

**WC711**

70" CONST - CONSTELLATION SERIES



**VU190021**

TURBOWING BRACKET  
STAND-UP SLEEPERS (PB, KW, FL)

**HOOD WINGS**



**11131**

HOOD WINGS - POWER STYLE -  
UNIVERSAL (EXCEPT KW) 42X9X6



**PRO TAIL WINGS**



**VU194000**  
PRO TAIL 72" X 18" HIGH ROOF FLAT  
TOPS ONLY



**VU194001**  
PRO TAIL 70" X 11" HIGH ROOF FLAT  
TOPS ONLY



**VU194002**  
PRO TAIL 70 X 19 - WING VERSION  
FOR CURVED ROOF (NON FLAT TOP)













# WARRANTY & RETURNS

Thank you for choosing Valley Chrome bumpers and Wingmaster, a division of Valley Chrome Plating, Inc., as your source for chrome and stainless steel custom truck accessories. Our family of products is fully guaranteed for fit, appearance and quality. Our mission is to provide you with the finest products at a fair price. Our reputation has been built in the trucking industry on our commitment to you, the trucking industry professional.

## LIMITED WARRANTY

Wingmaster extends a warranty against defects in material and workmanship for a period of one year. LED light assemblies come with a three year limited warranty. This warranty is void by damage or defects in appearance due to accident, abuse, alterations to the product, improper installation, corrosive environments or any other abnormal conditions. This warranty applies only to the original purchaser of the product and covers only the defective part, whether it is a single item or component part of a purchased group. The warranty year begins upon purchase of the product by the end user. All requests for warranty must include the original invoice. Serial numbers must be provided for bumpers, wings and any other serialized parts. There is no warranty for setback axle bumpers ("break-backs") greater than 18". Flat bumpers greater than 18" wide may require additional brackets and bracing (not included) to avoid cracking, and may not be warranted if our company determines the bracing is insufficient.

## RETURN POLICY

Products must be returned to our Clovis, Ca. facility with a Returned Goods Authorization number, freight prepaid. Items sent without an R.G.A. number or freight collect will be refused. Wingmaster reserves the right to repair or replace the item at our discretion. Warranted items will be returned freight prepaid upon acceptance of our responsibility of the defect. Please contact our customer service staff for this number. Items may not be returnable due to age or stored condition, which is at our company's discretion.

## FREIGHT POLICY

All freight is F.O.B. from our Clovis, Ca. facility unless prepaid conditions are met.

Prepaid freight for bumpers and wings to Valley Chrome/Wingmaster dealers is ten or more units. Bumpers and wings may be combined to achieve prepaid status. Accessory orders must total \$1,000.00 U.S. or more. for prepaid freight.

Accessories may be combined with bumper and/or wing orders at our discretion.

## IMAGES IN THIS CATALOG

The images shown in this catalog are best representations of our products, however, they are representative only and may sometimes not match actual product. Add-on items shown in images, such as external tow apparatus, fog lamps and other non-Valley Chrome/Wingmaster items attached to bumpers and accessories are not included in the product offered.

## UPDATED INFORMATION

Information in this catalog, when printed by our company, is made as accurate as possible at the time of printing. For the most current information, including error corrections, see the most current catalog posted on our website. Because of the truck and automotive industry's aftermarket publishing inconsistencies, some model years and vehicle models indicated in this publication may vary slightly from the actual model. Obtain product drawings and photos from our customer service staff to verify product fit prior to ordering.



Call for a Dealer Near You **1.800.354.0976**  
[www.valleychrome.com](http://www.valleychrome.com) • 1028 HOBLITT AVE. • CLOVIS, CA 93612 • USA

*Bumpers & Wingmaster  
Stainless Accessories are...*

FOLLOW US

